



# HERITAGE™ & CONVENIENCE GROUP WITH TURBO POWER

**Use & Care  
Booklet.**



**SAVE THESE  
INSTRUCTIONS.**

Important: Read all instructions,  
warnings and safeguards before using.

**Kirby®**



# Congratulations

on becoming a Kirby owner.

With proper care your Kirby Cleaning System will give you a lifetime of service. Because it was designed and built using reliable, high-quality materials.

The Kirby cleaning system gets the cleaning job done faster and easier, leaving more time for yourself or your family.

In the event you require service or information about Kirby attachments and accessories, talk to your authorized independent Kirby distributor or dealer. There's one near you. Check your telephone Yellow Pages.

To fully appreciate the capabilities of the Kirby, please read this **Use and Care Booklet** thoroughly. The information and specifications included here were in effect at the time of printing. The Kirby Company reserves the right, however, to discontinue or change specifications or designs at any time without notice and without incurring any liability whatsoever.

**NOTE:** Pull this cover out and use detailed drawing of Kirby Heritage™ while following the step-by-step instructions in this booklet.

## Table of Contents

Parts List & Controls .....	3
Standard Attachments .....	4
Important Safeguards .....	6
<b>VACUUM CLEANER BAGS.</b>	
Disposable Filter Bag System .....	7
Reuseable Bag System .....	8
<b>UPRIGHT CLEANER.</b>	
Carpet Vacuuming .....	10
Straight Suction Cleaning .....	11
<b>MATTRESS CLEANER.</b>	
Converting to a Mattress Cleaner .....	12
<b>TANK CANISTER CLEANER.</b>	
Attaching the hose .....	14
<b>ATTACHMENTS.</b>	
Crevice Tool, Duster Brush, Utility Brush Nozzle Shoulder Strap, and Flexible Hose .....	16
Extension Wands and Surface Nozzle .....	17
<b>TURBO BRUSH, DEEP CLEANING PORTABLE.</b> .....	17
<b>SERVICE TIPS.</b>	
Service Tips .....	18
Belt Replacement .....	20
Trouble-Shooting .....	21
Owner's Registration Card .....	22
Limited Warranty .....	23
Accessories .....	24-26
<b>INDEX.</b> .....	28-29

# KIRBY HERITAGE™ Parts List & Controls.

- 1—Optional Reuseable Bag System
- 2—Disposable Paper Bag
- 3—Nut
- 4—Clip in Top Slot
- 5—Handle Grip
- 6—Upper Cord Hook
- 7—Spring
- 8—Screw
- 9—Upright Handle
- 10—Power Cord
- 11—Cord Attaching Groove
- 12—Handle Pin
- 13—Power Plant
- 14—Attaching Bar
- 15—Rug Nozzle
- 16—Belt Lifter
- 17—Accessory Lock
- 18—Air Outlet
- 19—Headlight Hood
- 20—Sani Em-Tor
- 21—Bag Guard
- 22—Cloth Filter Bag and Hanger
- 23—Suction Seal Ring Gasket
- 24—Em-Tor Gasket
- 25—Power Shaft
- 26—Speed Selector
- 27—Clip on Top
- 28—Handle Stop Latch
- 29—Disposable Bag System
- 30—Toe-Touch Control
- 31—Foot Switch

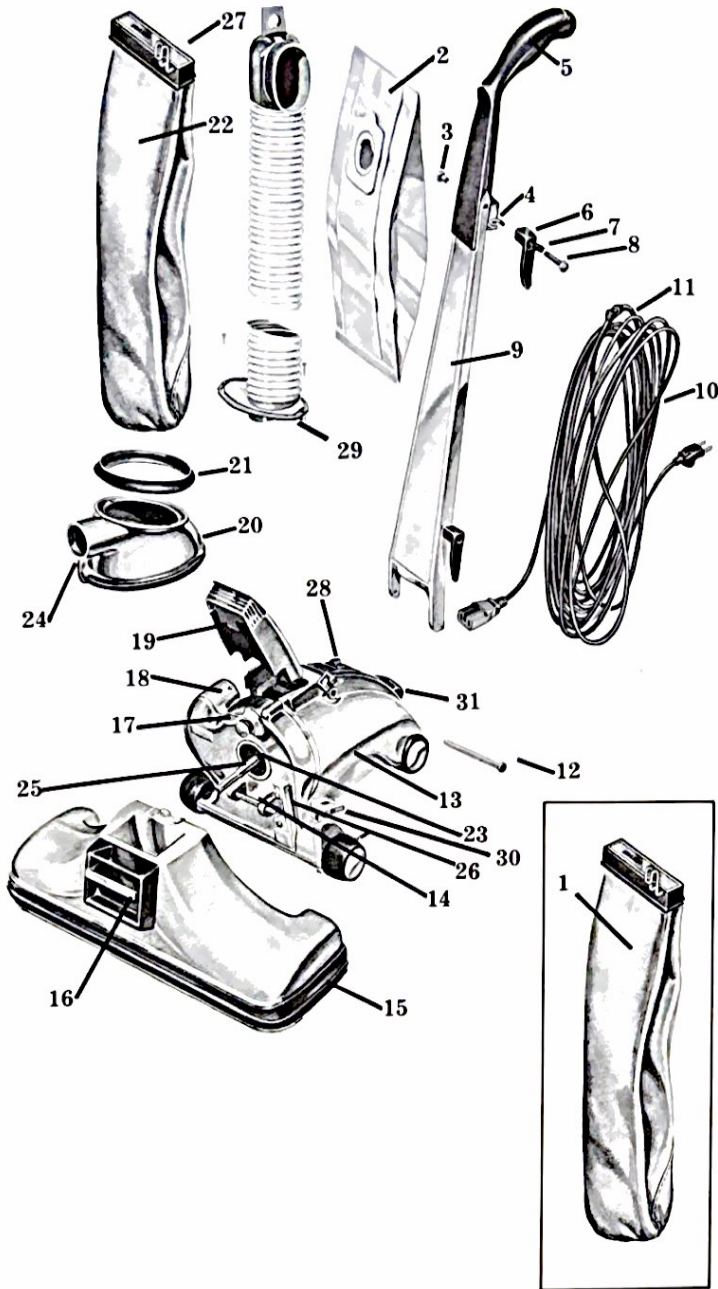

## Standard Attachments.

Here are the standard attachments for your Kirby. Each is designed for specific household cleaning jobs. The spare belt can be used with all accessories and attachments which are belt driven, except the Turbo Brush and Handi-Butler. There are detailed instructions for the use of each attachment in later sections of this booklet. Clean each attachment free from lint and keep brushes free from lint and fibers.



**EXTENSION WANDS.**  
Lightweight, yet strong. Lock securely together. Contain safety air bleeder holes.



**CREVICE TOOL.**  
with removable brush. For crevices in furniture without the brush, and for cleaning radiators and other hard-to-dust places with the brush.



**UTILITY BRUSH NOZZLE**  
For walls, bare floors, ceilings and large, flat hard surfaces.



**SURFACE NOZZLE WITH SWIVEL ATTACHMENT.**  
With brush adjustment lever. For cleaning under low objects, such as couches or television consoles.



**TURBO BRUSH.**  
With mechanical power brushing action to clean difficult places thoroughly.



**HOSE.**  
Lightweight, flexible, durable, easy-to-use.



**PORTABLE HANDLE WITH SHOULDER STRAP.**  
Makes your Kirby more versatile and easier to use in a variety of places.



**DUSTER BRUSH.**  
For end tables, shutters, lamp shades, window moldings, cornices, door jams, baseboards, books, picture frames, air conditioning and heating duct openings.

Also included with the basic Kirby cleaner are the following items: ODORIFIC (one bottle). An effective all-purpose deodorizer. ROOM AND CARPET HOME FRESHENER (7 oz. container). Lemon scented to remove pet odors, cooking odors and odors caused by dampness. KIRBY DISPOSABLE BAGS (two). SPARE BELT (one). Can be used with any of the belt-driven accessories, except the Turbo Brush and Handi-Butler.



# IMPORTANT SAFEGUARDS.

## Read all Instructions, Warnings, and Cautions before Using!

The Kirby system is listed by Underwriters Laboratories, Inc. as a Double Insulated Domestic product for use on 120 volts 60 hertz household power.

### WARNING

Electric shock could occur if used outdoors or on wet surfaces.

These guidelines, and others found throughout this book, are presented for your protection and convenience. Please read them carefully, since a failure to heed these precautions could result in discomfort or injury. When using electrical appliances, especially when children are present, basic safety precautions should always be followed.

**ALWAYS BE SURE MOTOR AND FAN HAVE COME TO COMPLETE STOP, AND UNPLUG CORD FROM WALL SOCKET BEFORE CHANGING ACCESSORY UNITS OR ATTACHMENTS.**

**DO NOT USE ANY ATTACHMENT NOT RECOMMENDED OR SUPPLIED BY THE KIRBY COMPANY, AND USE ONLY AS DESCRIBED IN THIS MANUAL.**

**NEVER LEAVE CLEANER UNATTENDED WHEN IT IS RUNNING OR WHEN CORD IS PLUGGED IN.**

**WHEN CLEANER IS RUNNING, NEVER ALLOW FINGERS, HAIR, FACE OR LOOSE CLOTHING TO COME NEAR INTAKE SUCTION PORTS, NOZZLE, OR REVOLVING BRUSHES.**

**REPLACE DAMAGED OR WORN PARTS WITH GENUINE KIRBY PARTS IN ORDER TO MAINTAIN SAFETY AND TO PROTECT YOUR WARRANTY.**

Never vacuum live fireplace ashes, cigar or cigarette butts.

Never run cleaner over power cord, or place sharp objects on cord. Keep cord away from heated surfaces. Don't close door on cord, or snag it under furniture or doors.

Never let invalids or children use or play with cleaner.

Use extra caution when cleaning on stairs.

Keep cleaner on floor—not on chairs, tables, etc.

When disconnecting power cord, grasp plug—not cord. Do not use cord to pull cleaner around. Do not close a door on it, or snag it under furniture.

Store cleaner, attachments, and accessory units promptly after each use to prevent accidents caused by tripping over power cord or equipment.

Always unplug cleaner immediately after using.

Don't use in an enclosed space where flammable, explosive, aerosol spray products, or toxic materials are stored or used, or where vapors from such materials may be present.

Don't use where oxygen or anesthetics are used.

Don't use cleaner to pick up hard or sharp items, such as coins, pins, nails, etc. They could damage the fan, fan housing or bag.

Never drop or insert any object into any opening of the cleaner.

Don't use cleaner, attachments, or accessory units if in poor condition. Have qualified service person inspect, replace, or repair whenever necessary.

Don't plug cleaner into a table lamp or light fixture.

Don't move tables, lamps, etc., while holding onto cleaner.

Check seals and gaskets regularly. Worn, damaged, loose or missing gaskets or seals can be a safety hazard.

Keep hose and attachments suction openings away from eyes, ears, mouth, and other parts of body.

### WARNING

To avoid electric shock:  
Never vacuum liquids.  
Never vacuum floors, rugs, or carpeting that are wet.  
Do not store outdoors.  
Replace worn or frayed power cord immediately.

Do not place or immerse cleaner in water or any other liquids.

Do not reach for cleaner that has fallen into water. Unplug cleaner immediately from the wall socket.

Never handle cord or plug with wet hands.

### WARNING

Before servicing always unplug power cord from wall outlet and be sure the motor and fan have come to a complete stop.

# VACUUM CLEANER BAGS.

The Kirby Heritage™ features two vacuum cleaner bag systems: the standard disposable filter bag system, and the optional reusable bag system.

## Disposable Filter Bag System. (Standard)

### How to change bags.

Before you begin, unplug the cleaner's electrical cord from **1** wall outlet.

Unzip the cloth bag **2** at rear of cleaner.



**3** To remove used bag, grip the top tab on the cardboard plate, pull back and lift out.

**4** To replace, slide new bag into outer cloth bag, making sure the cardboard plate faces front of cleaner.



**5** Hold the top tab on the cardboard plate while hooking the bottom of the opening under the lower lip of the bag retainer. Once the bottom is secure, pull the top tab up and over the upper lip of retainer.



**6** Your bag should now be snapped into place—check to make sure the cardboard plate is fully on the bag retainer.

**7** Zip the cloth bag closed.  
**NOTE:** When changing the disposable filter bag, empty the Sani Em-Tor of any large particles which may have settled there.

**For best results:** Never reuse filter bags — this could damage the cleaner. Periodically check to make sure the air passage openings to the filter bag are not blocked. **For peak efficiency and performance, use genuine Kirby replacement parts.**

# VACUUM CLEANER BAGS.

## Reusable Bag System. (Optional)

The Sani Em-Tor and Sani-Pocket are patented Kirby features that enable easy and efficient emptying of the reusable cloth filter bag.

### Emptying the Filter Bag.

- 1** Spread newspaper on the floor and place Kirby on it.
- 2** Detach wire loop on top end of the bag from handle bracket. Tilt handle back slightly. Push bag top toward handle and lift loop out of bracket.

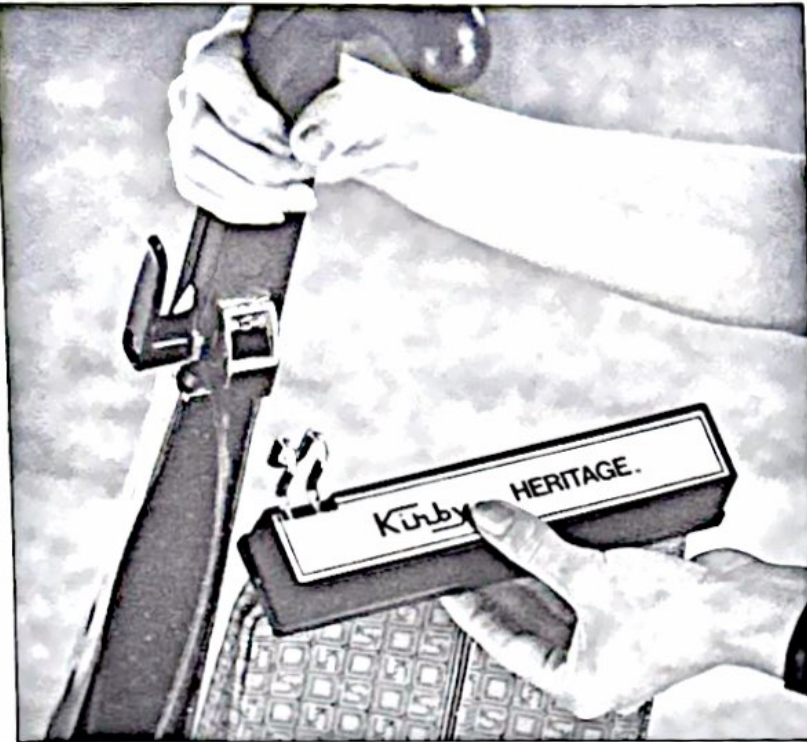

**3** Lower rug nozzle to No. 1 position (as shown) and turn on motor.

**4** Allow motor to run briefly and then turn off. While bag is still extended, shake it vigorously from the top.

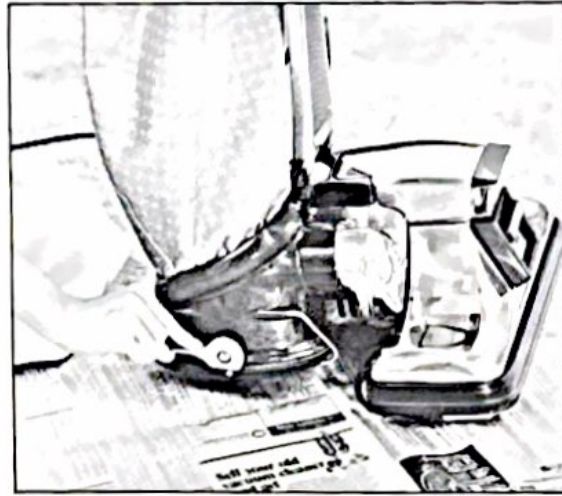

**5** Tilt Kirby slightly and rotate side lever fully to release bottom cover of Sani Em-Tor. In the "open" position the lever will point to the rear of the Kirby.

**CAUTION!**  
Unplug the cord.

Swing cover out from under **6** Sani Em-Tor and turn cover upside down, emptying the dirt and lint onto the paper.

After all dirt has been removed, swing cover back into place and lock securely **7** with locking lever. Make sure that cover gasket is free of dirt and that lever handle is fully rotated.

If excessive dirt and lint has accumulated in the bag, and does not fall readily into the Sani Em-Tor, use the following procedure.

Open zipper at rear of bag and place hand inside Sani-Pocket, grasping Sani-Scraper at bottom.

Scrape sides of bag with Sani-Scraper in downward strokes.

Using Sani-Scraper, push excess lint and dirt into Sani Em-Tor.

Empty as in "5" through "7" above.



# UPRIGHT CLEANER.

## Carpet Vacuuming.

### Upright Cleaning.

It's important to have the rug nozzle height set properly to get the most efficient cleaning action. Start out with the Toe-Touch control (30) adjusted to the full up (number 8) position. Then, by pressing your toe downward on the upper part of the Toe-Touch Control, lower the nozzle one step at a time until you notice a change in the sound of the power plant. This indicates that the nozzle is in contact with the rug and ready to clean. Any position lower than this will restrict proper air flow and reduce belt life.

### Straight suction cleaning.

By converting the Kirby upright into a straight suction cleaner, you can easily vacuum bare floors and short pile carpeting.

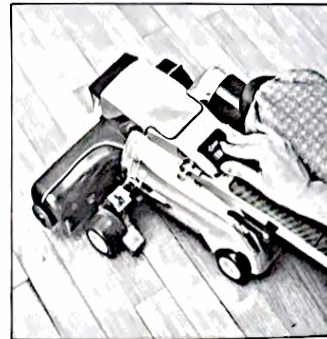

### Sweeping Pattern.

For the best and easiest cleaning action, push the machine straight away from you and pull it straight back. Change the direction of the machine at the end of the pull back and point it in the direction of the next sweeping path. Continue to do this across the entire rug with slow, gliding motions. Do not jerk or tug the cleaner rapidly on back stroke or when changing directions.

### Handle Positions.

When the handle stop latch (28) is pushed to the left a pin extends. This pin will stop the handle from being lowered back to the horizontal. It will lock the handle in the horizontal position for storage, if it is extended with the handle down.

When the pin is out and the handle is upright, pulling back on the handle will cause the front of the machine to tilt up so that it can be moved over obstacles, such as carpet strips or throw rugs.

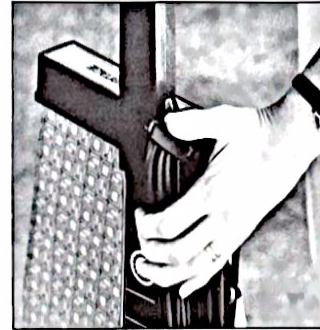

### Cord Release.

To release cord, turn down the upper cord hook on the handle. Cord will drop free into your hand.



### Converting to a straight suction cleaner.

**1** Raise the headlight hood and turn the Belt Lifter (16) fully counterclockwise. Check the instruction label on top of the rug nozzle to be sure that the belt is disengaged.



**2** Lower the headlight hood against the Belt Lifter. With the belt disengaged the brush roll will not turn and the Kirby becomes a straight suction cleaner.

# MATTRESS CLEANER.



It takes just a few steps to convert your Kirby Heritage into a hard-working mattress cleaner.

## Converting to a Mattress Cleaner.

### WARNING:

Before changing units or attachments, unplug power cord from wall outlet, and be sure motor and fan have stopped.

**1** Unhook clip on top (27) of handle. Pull power cord from the bracket on the back of the handle grip. Release it from the handle fork rear cover clips.



**2** Pull handle pin (12) all the way out and lift handle off the cleaner.



**3** Slide portable handle into the handle channel on the power plant. Push handle pin back in to fasten the portable handle to the power plant. Be sure pin goes through the holes on both sides of the portable handle.



**4** Slide Handle Stop Latch (28) fully in direction of arrow to lock portable handle in place.

**5** Position bag clip (27) on portable handle as shown.

**WARNING:**  
Failure to disengage brush roll can be hazardous. Keep hair, clothes, buttons, face and fingers away from the nozzle.

Raise the headlight hood (19) and turn the Belt Lifter fully counter-clockwise. With the belt disengaged the brush roll will not turn and the Kirby becomes a straight suction mattress cleaner.



# TANK CANISTER LEANER.



## Attaching the hose.

To use the above-the-floor tools, the flexible hose must be attached to the front of the Kirby.

### WARNING:

Before changing units or attachments, unplug power cord from wall outlet, and be sure motor and fan have stopped.

- 1 Move the Toe-Touch Control (30) to the Number 8 position. Then raise headlight hood.

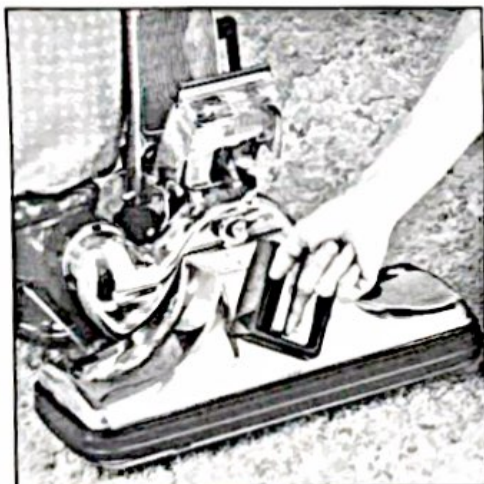

- 2 Turn the Belt Lifter (16) counterclockwise, or all the way to the left until it stops. (See instruction label at top of nozzle.)



- 3 Unlock the accessory lock (17) that's located under the hood by moving it all the way to the left. Rug nozzle should drop forward slightly.



- 4 Remove rug nozzle (15) by lifting it up slightly and pulling it toward you. Now you are ready to install the hose.

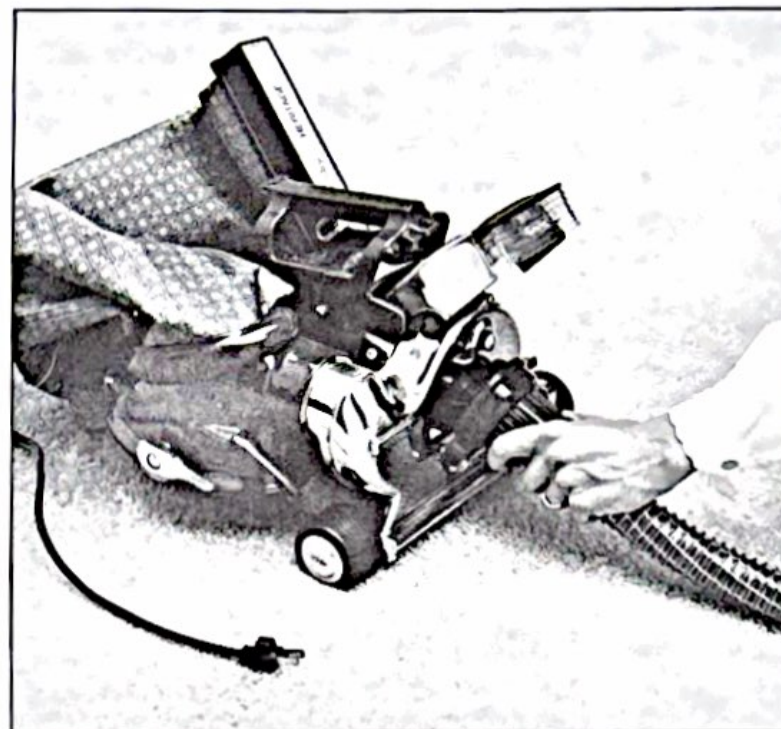

- 5 Hook the attaching lugs of the large coupling on the flexible hose over the ends of the attaching bar (14) on the power plant and swing the hose coupling end up against the power plant.



- 6 Rotate the accessory locking lever (17) until hose connector is tightly closed and sealed against power plant. Close the headlight hood.

The Kirby is now ready for above-the-floor cleaning and is ready to accept any of the hose attachments that come with your Kirby.

## How to attach tools to the hose.

- 1 To attach tools, push lightly while twisting the connection of the smaller end of the hose into the desired tool.

- 2 Extension tubes and swivel elbow are assembled in the same manner. To avoid breakage, do not jam or force the coupling ends into the attachments.





# ATTACHMENTS.

# TURBO BRUSH.



## The Crevice Tool.

For deep cleaning in crevices, cracks, corners, grooves, narrow openings, and behind seat cushions of upholstered furniture, attach the crevice tool without the removable brush to the flexible hose or to the extension tubes.

With the removable brush placed in the end of the crevice tool, you have a cleaning tool that removes dirt from corners, between radiator coils, venetian blinds, and sliding window tracks.



## Utility Brush Nozzle.

Attach to end of extension tubes and use for cleaning walls, ceilings and large flat surfaces.



## The Duster Brush.

Attach the duster brush to the end of the flexible hose or to the extension tubes and you can remove dust from any surface, including those with contours, such as moldings or delicate lamp shades and unusual shapes.



## Portable Shoulder Strap.

The shoulder portable is ideal for cleaning in areas where considerable mobility and freedom of hands is required.

Remove the carrying strap from the attachment case and clip the spring clip on each end into the holes at front and back of the portable handle.

Slide the adjusting buckle on the carrying strap so the portable cleaner rests comfortably on your shoulder.

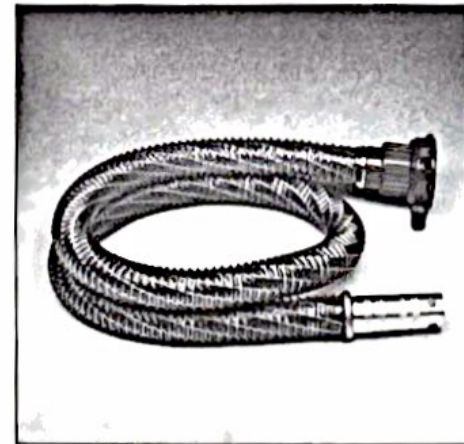

## Storing the Flexible Hose.

Never store the flexible hose near a heat source. Keep it in a cool, dry place and never hang it on a sharp hook or nail. Store it in a place where it will be readily available.

## Turbo Brush.

Ideal for deep cleaning of carpeting and stair treads, as shown.



For maximum cleaning efficiency, keep base plate of Turbo Brush level with the surface being cleaned. The rotating brush may cause particles to be thrown from rear of base plate, if not held level. To reduce suction when vacuuming draperies, clothing, etc., open slide valve (32). Do not insert fingers in open slide valve.

## WARNING

Keep hair, clothes, face and fingers away from rotating brush. Disconnect unit from Kirby before servicing.



## Turbo Brush.

This unique portable cleaner makes difficult hand vacuuming jobs easy. Turbo Brush uses a mechanical brushing action to do a thorough cleaning job on carpeted stairs, upholstery, drapes—anywhere an upright cleaner can't be used.

**CAUTION:** When using the Turbo Brush, keep it moving across the surface to be cleaned. Do not let it remain in one place.

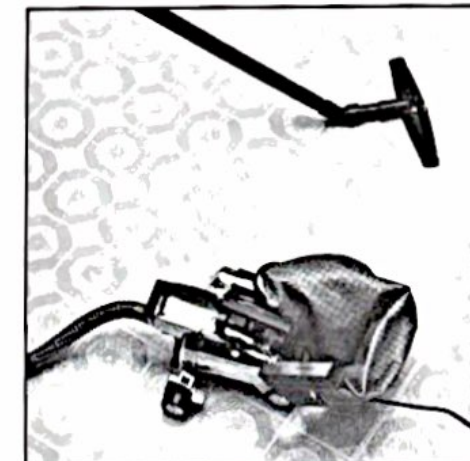

## Extension Wands.

Attaching the curved extension tube to the hose, the straight extension tube to the curved tube, the swivel tube to the straight tube, and the surface nozzle to the swivel gives you maximum reach.

Attaching the hose to the straight tube and adding the curved extension tube on the straight extension tube and utility brush nozzle makes an effective wall, ceiling, and baseboard cleaning arrangement.

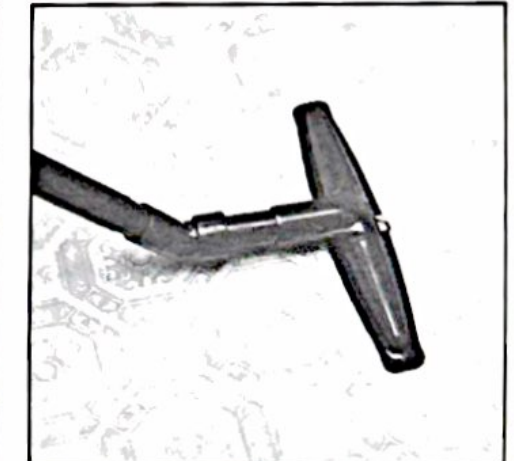

## Surface Nozzle with Swivel Attachment.

The surface nozzle with brush extended is for use on carpeted floor areas. It has a lever on the front of its housing which allows you to raise or lower the brush. The up position of the brush is recommended for the cleaning of deep pile or loose throw rugs.

# SERVICE TIPS.

Your Kirby has been designed and manufactured to give you many years of normal in-home usage with relatively little maintenance required.

The Kirby motor has permanently lubricated and sealed ball bearings and will not need lubrication. If bearings become noisy, repair of the motor must be done only by authorized qualified Kirby service personnel.

To maintain your Kirby in good, serviceable condition, it should be inspected periodically by an authorized Kirby service person.



## Headlight bulb replacement.

**1** Raise the headlight hood on the power plant. With a Phillips head screwdriver, loosen the two screws that hold the headlight lens to the hood.



**2** Unplug the lens and socket assembly from the terminal block. Replace the bulb, plug in the lens and socket assembly, and replace the screws.

**NOTICE.** All service and maintenance required other than those things described in this book should be done by authorized qualified Kirby service personnel using genuine Kirby replacement parts.

### WARNING.

Before servicing, always unplug power cord from wall outlet and be sure the motor and fan have come to a complete stop.

### WARNING

Remove Turbo Brush from unit before servicing. Beware of sharp objects that may become lodged in brush.

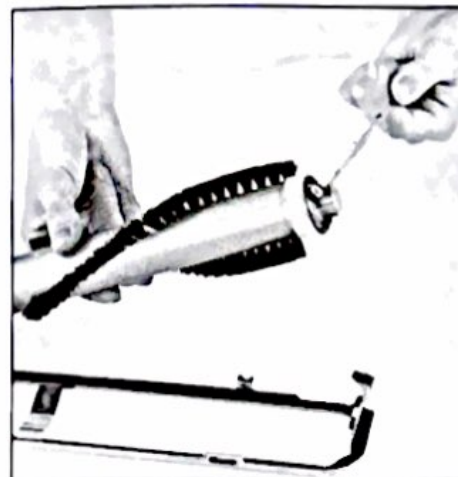

## Brush cleaning of Rug Nozzle.

Keep the brushes and belt track clear of lint, string, hair, and other fibers. Pay particular attention to keeping these fibers away from the bearings at the ends of the brush roll.

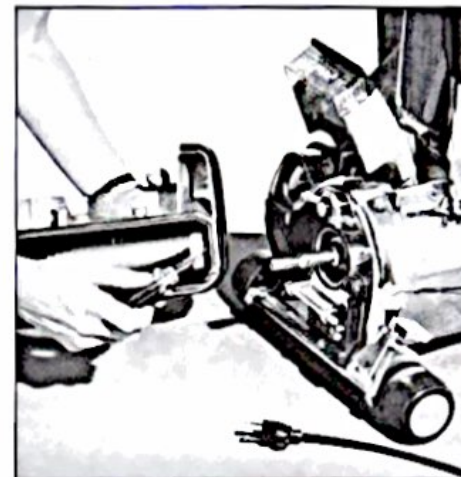

## Brush adjustment of Rug Nozzle.

After the rug nozzle has been in use for some time, the brush bristles may begin to wear. To adjust the brush height, place the rug nozzle on a table. Place a straight edge on the nozzle plate next to brush tufts to see

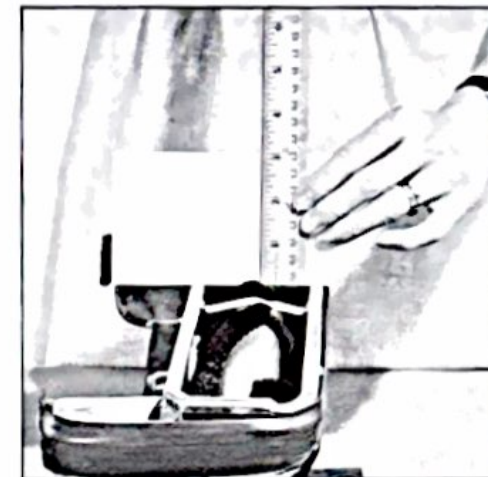

protrusion. Turn both screws clockwise an equal amount until the brushes protrude about 1/16 inch past the rug plate. One full turn of these screws moves the brush out about 1/32 inch. Make certain brush roll is kept parallel with rug plate or belt will not center between tufts.



## Brush cleaning of Turbo Brush.

Remove base plate by sliding bottom latch back. Clean turbine and/or brush, then replace base plate by inserting tabs into slots on front of unit attaching at bottom latch.



## Brush adjustment of Turbo Brush.

To adjust brush to compensate for bristle wear, remove base plate by sliding bottom latch back. Next, remove the belt cover (33) by removing the screw. Finally remove the belt from the pulley. (An aid to belt removal is to turn brush backwards slightly.) Pull the brush assembly out. Turn brush assembly over and re-insert



so that number "1" is showing at both ends.

**NOTE:** The brush roll comes from the factory with a "2" showing at both ends of the brush roll assembly.

When adjusting brush, make sure no brush bristles are caught between belt and brush roll gear.

**CAUTION:** Do not operate with belt cover (33) removed.

# SERVICE TIPS.

## Belt replacement for Rug Nozzle.

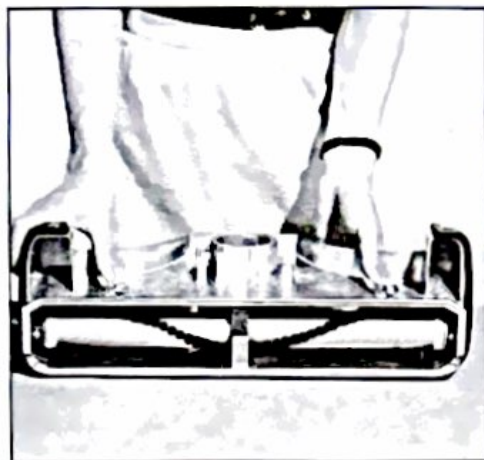

**1** To replace the belt in the rug nozzle, remove the nozzle from the motor and place the nozzle on a table.

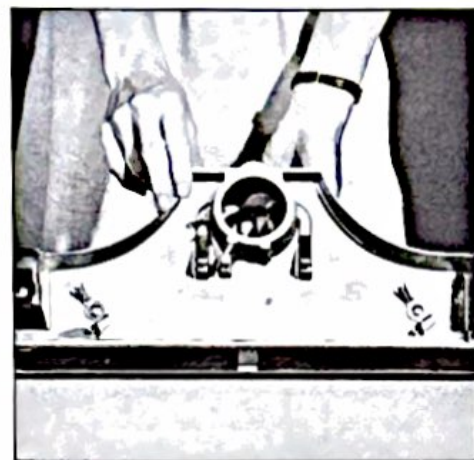

**2** Turn the Belt Lifter all the way clockwise until the belt drops off the finger inside the nozzle. Turn nozzle upside down. Unlock rug plate by means of two latches on rear of nozzle.

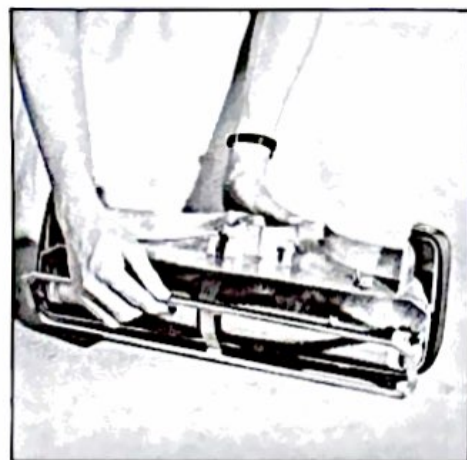

**3** Pull up on rear of rug plate to pull brush roll and plate out of nozzle.

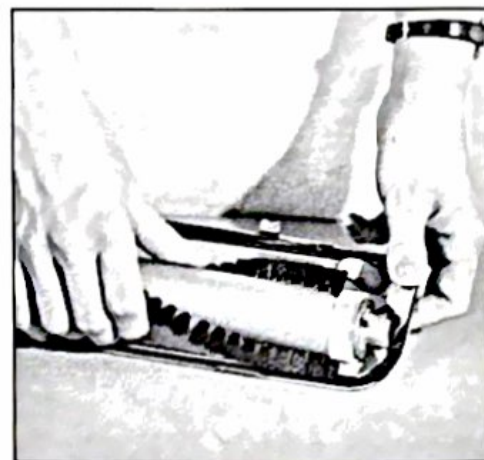

**4** Bend slightly one end bracket of the rug plate away from one end of brush.

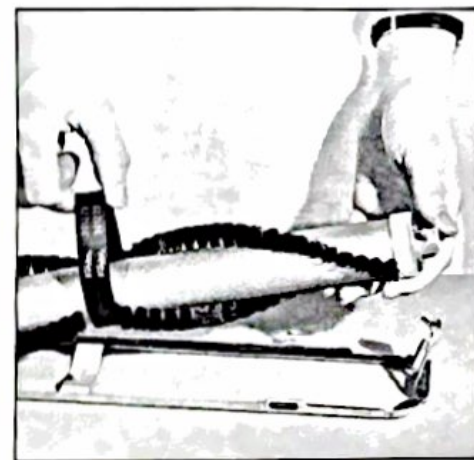

**5** Slide the belt off the roll and slide on a new belt. The new belt must be in the middle of the roll. Place the roll back into the end bracket with the screw heads facing the openings in rug plate.



**6** Hook rug plate on front of nozzle and rotate it back against nozzle opening and make certain it fully closes against nozzle. Rotate latches to lock plate in place, and center belt under rug plate center rib. Turn the Belt Lifter counter-clockwise until the finger in the nozzle picks up the belt.

## Belt replacement for Turbo Brush.

**WARNING**  
Remove Turbo Brush from unit before servicing.

Remove base plate by sliding bottom latch back and belt cover (33) by removing screw. Next, remove belt from pulley (may help to turn brush backwards slightly). Pull belt and brush assembly out and replace belt. Before replacing base plate and belt cover, make sure a "2" is showing at both ends



of brush roll assembly, and no brush bristles are caught between the belt and brush roll gear. If brush roll bristles are worn, see brush adjustment instructions on page 19.

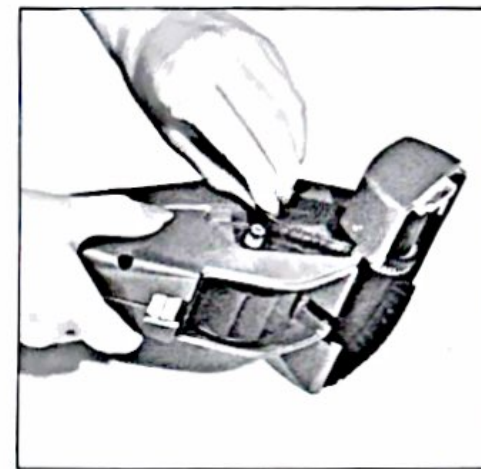

## Troubleshooting.

Many service calls are unnecessary. Checking a few simple things can save a lot of cost, time and trouble. Whenever your Kirby does not perform properly, make these checks first before calling authorized service personnel.

**If the motor does not start when the motor ON-OFF switch is pushed:**

1. Make sure the power cord is plugged into an outlet and that the outlet has power. (Check for tripped circuit breaker or power company trouble.)
2. Make sure the cord plug is fully inserted into the cleaner.
3. Look for breaks in the power cord insulation. If the cord is damaged, get a new one. **DO NOT ATTEMPT TO REPAIR IT.**
4. Make sure that an attachment or accessory is properly mounted on the front of the power plant.

**If the Kirby does not pick up lint or litter on the carpet:**

1. Make sure that the belt is on the brush roll and on the power plant drive pulley.
2. Make sure that the belt is not broken or slipping. Replace if

necessary.

3. Check suction seal ring gasket on front of cleaner to see that it's not missing or damaged. Do not use cleaner without a gasket.
4. Check to see that suction seal ring gasket is not missing in the hose connector. Do not use if missing or damaged.
5. Check to see if rug plate on carpet nozzle is properly attached and latched.
6. Make sure that the Toe-Touch control is adjusted to place the nozzle in contact with the rug.
7. Make sure the brush roll is adjusted properly and the bristles are not worn out. 1/16 inch of tuft should extend out of nozzle plate. Check with ruler against nozzle. Replace or adjust as required.
8. Make sure bag is not full.
9. Check to be certain that fill tube and Sani Em-Tor are not clogged.

**If the Sani Em-Tor is loose:**

1. Make sure it locked in position.
2. Make sure the rubber gasket inside the collar of the Sani Em-Tor is properly in place; dirt will blow out if it is not. Replace if the Sani Em-Tor gasket is missing or damaged.

**If the brush roll in any accessory does not turn:**

1. Make sure the belt is not broken or worn out.
2. Make sure the belt is in place around the brush roll and on the power plant pulley.
3. Check to see if brush roll can be rotated.

**If the Kirby is hard to push when the rug nozzle is attached:**

1. Make sure the nozzle is not set too low. Raise the Toe-Touch control one or two notches.
2. Make sure that the belt is on the brush roll and on the power plant drive pulley.
3. Make sure that the belt is not broken or slipping. Replace if necessary.

## The sign of Kirby quality.

Whenever you require service or desire to purchase one of the many accessories available for your Kirby Heritage™, look for this sign of the Authorized Kirby Distributor. You'll find it on his store front and in your telephone Yellow Pages. It's your assurance of qualified service and expert assistance.



## Owner Registration.

To register for your Kirby Rebuilding Agreement, please complete the Owner Registration card that is packaged with your cleaner. To insure proper registration, check to see that the serial number on your cleaner corresponds with the number on the card.

## Important Notice.

The Kirby Company provides a valuable rebuilding service for the owner of a Kirby purchased from an Authorized Kirby Distributor, when the unit is purchased for personal, family, or household use. To register for that service, make sure that your Rebuilding Agreement Card has been properly filled out and signed by the salesperson at the time of sale, and a copy has been left with you. Keep that card in a safe place.

THE SERIAL NUMBER ON YOUR MACHINE SHOULD MATCH THE SERIAL NUMBER AT THE UPPER RIGHT CORNER OF THE CARD.

That Kirby Rebuilding Agreement, and the Limited Warranty which is described on the opposite page, are each null and void if the name plate or serial number of the Kirby has been defaced, removed, or changed (other than by fire or other casualty or accident, or in connection with the factory rebuild) and the Kirby Rebuilding Agreement is null and void if the Kirby was not purchased from an independent authorized Kirby distributor, or dealer who signed the Rebuilding Agreement Card and filled in the date and serial number.

PROTECT YOUR RIGHTS: IN ORDER TO ASSURE THE VALIDITY OF YOUR REBUILDING AGREEMENT, MAKE SURE YOU ARE

1. PURCHASING FROM AN INDEPENDENT AUTHORIZED KIRBY DISTRIBUTOR OR DEALER;
2. THE REBUILDING AGREEMENT CARD IS FILLED IN AND SIGNED;
3. THE ORIGINAL NAME PLATE AND SERIAL NUMBER ARE INTACT.

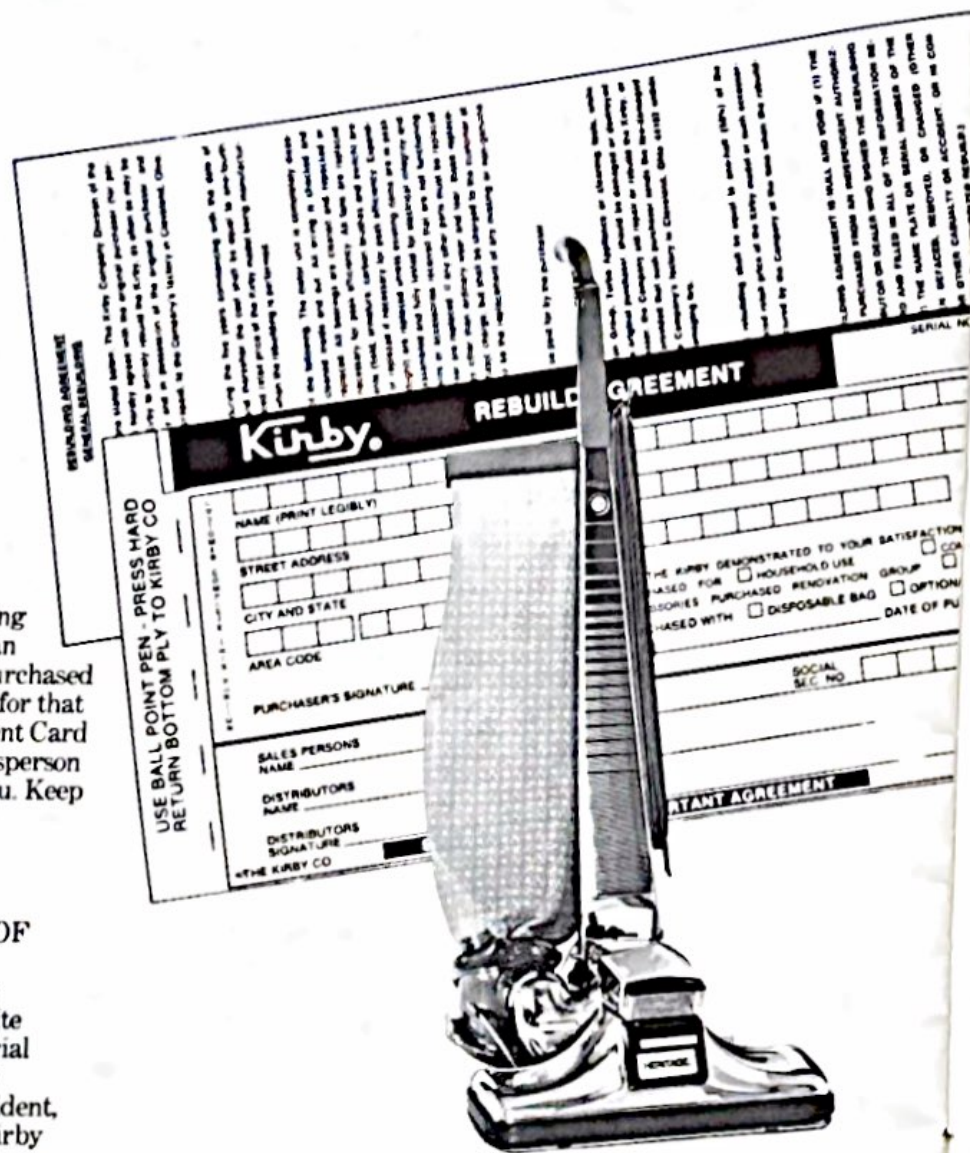

# LIMITED WARRANTY

Subject to the conditions and exceptions stated below, The Kirby Company ("Company") warrants to the original purchaser (OTHER THAN FOR PURPOSES OF RESALE) that each Kirby product shall be free from defects in material and workmanship, under normal use and service, as follows: (a) for two (2) years from the date of purchase by the original purchaser when used for personal, family, or household purposes ("consumer purposes"); (b) for one (1) year from the date of purchase by the original purchaser when used for commercial, professional, rental, institutional, etc., purposes ("commercial purposes"); (c) for one (1) year from the date of any factory repair or rebuild provided to the original purchaser under the terms and condition of the KIRBY REBUILDING AGREEMENT. During the applicable warranty period, the Company will furnish for the Kirby product a replacement part for any part found to be defective, through an authorized Kirby Distributor. All transportation expenses must be borne by the purchaser. This Limited Warranty does not apply to motor brushes, belts, light bulbs or other expendables, such as buffing pads, compounds, etc., charges for labor or service calls, damage caused by accident, misuse, negligence, abuse, or to any Kirby product which has been repaired so as in the judgment of the Company to affect its stability or reliability, or in which parts not approved by the Company shall have been used. In approving the Kirby for double insulation, UNDERWRITERS' LABORATORIES REQUIRES THAT ONLY IDENTICAL PARTS SHOULD BE USED IN SERVICING THE SEALED MOTOR UNIT.

The foregoing provisions state the exclusive remedy for any breach of warranty or any other claim in respect of any Kirby product. THERE IS NO OTHER EXPRESS WARRANTY, IMPLIED WARRANTIES, INCLUDING THOSE OF MERCHANTABILITY AND FITNESS FOR A PARTICULAR PURPOSE,

ARE LIMITED TO TWO (2) YEARS FROM THE DATE OF PURCHASE BY THE ORIGINAL PURCHASER, IN THE CASE OF KIRBY PRODUCTS USED FOR CONSUMER PURPOSES; TO ONE (1) YEAR FROM THE DATE OF ANY FACTORY REBUILD PROVIDED TO THE ORIGINAL PURCHASER UNDER THE TERMS AND CONDITIONS OF THE KIRBY REBUILD AGREEMENT; AND TO ONE (1) YEAR FROM THE DATE OF PURCHASE BY THE ORIGINAL PURCHASER, IN THE CASE OF KIRBY PRODUCTS USED FOR COMMERCIAL PURPOSES; AND ANY IMPLIED WARRANTY OF FITNESS FOR COMMERCIAL USE IS HEREBY DISCLAIMED. THIS IS THE EXCLUSIVE REMEDY, AND ANY LIABILITY FOR INDIRECT OR CONSEQUENTIAL DAMAGES OR FOR ANY INCIDENTAL EXPENSES, IS EXCLUDED. Some states do not allow limitations on how long an implied warranty lasts, or do not allow the exclusion or limitation of incidental or consequential damages, so the above limitations may not apply to you.

The Company neither assumes or authorizes any other person to assume for it, any additional liability in connection with the sale of its products.

THE LIMITED WARRANTY IS NULL AND VOID IF THE NAME PLATE OR SERIAL NUMBER OF THE KIRBY HAS BEEN DEFACED, REMOVED, OR CHANGED (OTHER THAN BY FIRE OR OTHER CASUALTY OR ACCIDENT, OR IN CONNECTION WITH A FACTORY AUTHORIZED REBUILD).

This Limited Warranty gives you specific legal rights, and you may also have other rights which vary from state to state.

Service calls and labor costs, including those during the warranty period, will be at the expense of the owner.



# ACCESSORIES.



## Heritage™ Super Renovation Group.

**Rug Renovator.** Your own personal carpet shampooing system. Easily attaches to your Kirby—gently and thoroughly deep-cleans your carpeting with low-moisture, controlled sudsing.

**Inflator/Deflator.** Handy attachment inflates low pressure inflatable toys and air mattresses up to one P.S.I. (pounds per square inch). Also used to remove all air from these items.

**Air Intake Guard.** Operates Sprayer/Suds-O-Gun and Inflator/Deflator. Attaches to Kirby power plant.

**Sprayer/Suds-O-Gun.** Sprayer is ideal for watering plants with fine mist—also for spray painting with non-flammable paint.

Suds-O-Gun expertly cleans color-fast upholstery.

**Floor Polisher and Carpet Fluffer.** Rug Renovator converts easily to a dual purpose appliance for polishing waxed floors or raising carpet pile.

**DANGER:** Do not use with flammable cleaning fluids.

**Instant Suds** (12 oz. bottle). Deep-cleaning suds formula that prevents resoiling. Specially formulated for use with Rug Renovator and Suds-O-Gun.



## Heritage™ Handi-Butler® Group.

A versatile attachment that creates a portable workshop in your home. Ideal for a variety of household jobs—buffing, sanding, drilling, polishing.

## ACCESSORIES.

### Heritage™ Home Turbo Group.



**Turbo-Sander.** A versatile sander that efficiently vacuums all sawdust, letting you sand all kinds of items right in your home with no mess. Also works as a massager or scrubber/buffer—with appropriate pads.

**Turbo-Groom.** A modern hair groomer that vacuums hair clippings before they hit the floor—minimizing clean-up. Comes with attachments to achieve professional results.

**Massage Cup.** Provides invigorating massage action for scalp or skin. Removes loose hair while grooming pets.

### And other Fine Kirby Products...



**Scuttle.** Makes cleaning as easy as spray on-wipe off. Perfect for windows, walls, chrome, woodwork, stainless steel, appliances, almost any washable surface.

**Room and Carpet Home Freshener.** Fast-working powered room freshener sprinkles on carpet—vacuums up in seconds. Delightful lemon scent.

**Handi-Waxer and Wax.** An efficient floor waxer used to apply Kirby Handi-Waxer wax. Uses extension wands from the Kirby cleaner for a handle. Handi-Waxer wax brings a lustrous, deep-gloss shine to tile, linoleum, vinyl, many other floor surfaces. Specially formulated for use with the Handi-Waxer.

**Odorific.** All-purpose deodorizer eliminates household odors instantly, economically up to 24 hours with only a drop.

**Instant Suds.** A product with a combination of cleaning power, resoiling resistance and fabric brightener makes it an outstanding rug and upholstery shampoo.

**Touch-up Paint.** A special touch-up paint that will keep the finish of your Kirby looking like new. Packaged in a convenient 3-pack.

**Replacement Belts.** Kirby replacement belts for your rug nozzle and Turbo-Brush to keep your system operating at peak efficiency.

**Disposable Filter Bags.** These bags are a must for your Kirby disposable bag cleaning system. Packaged in 3 and 12 packs.

#### WARNING.

Please keep these products out of the reach of children. May cause irritation if swallowed or placed in eyes.

#### Kirby Care Kit.

Kit includes everything needed to remove common spots and stains from upholstered furniture and carpets.

# INDEX.

## A

Above Floor Cleaning	14, 15, 16
Above Floor Tools	4, 13, 14, 15, 16
Accessories	24, 25, 26
Accessory Lock	3, 14, 15
Air Outlet	3
Attaching Bar	3, 15
Attaching Lugs	15
Attaching Tools to Hose	15
Attachment List and Explanation	4

## B

Bag Guard	3
Belt Lifter	11, 14
<b>Belt Replacement</b>	
Floor Nozzle	20
Turbo Brush	21
<b>Brush</b>	
Crevice Tool	4, 16
Surface Nozzle	4, 17
Turbo Brush	4, 17
<b>Brush Adjustment</b>	
Rug Nozzle	19
Turbo Brush	19
<b>Brush Cleaning</b>	
Rug Nozzle	19
Turbo Brush	19
<b>Brush Roll</b>	
Rug Nozzle	19
Turbo Brush	19
Bumper Rug Nozzle	3

## C

Cannister Flexible Hose	4, 15, 16
Carpet Vacuuming	10, 11
Changing Disposable Bags	3, 7
Cloth Filter Bag	3, 7, 8
Cloth Filter Bag Hanger	3, 8
Controls	3
<b>Converting to</b>	
Deep Cleaning Portable Cleaner	17
Straight Suction Cleaner	11
Straight Suction Mattress Cleaner	12
Tank Cannister Cleaner	14, 15
Cord	3, 12, 14, 18, 21
Cord Clip	3, 12
Crevice Tool	4, 16
Crevice Tool Brush	4, 16
Curved Extension Tube	4, 16

## D

Deep Cleaning Portable	17
<b>Disposable Bag</b>	
Changing	7
Top Fill Hose	7
Disposable Bag System	3, 7
Disposable Vacuum Bags	3, 4, 27
Duster Brush	4, 16

## E

Emptying Cloth Bag	8, 9
Emptying Sani Em-Tor	8, 9
Extension Wands	4, 17

## F

Flexible Hose	4, 15, 16
Flexible Hose Storage	16
Foot Switch	3
Freshener, Room and Carpet	4, 27

## H

Handle Channel	12
Handle Grip	3
Handle Pin	3, 12
Handle Positions	10
Handle Stop Latch	3, 10
Headlight Bulb Replacement	18
Headlight Hood	3, 11, 14, 18
Height Adjustment	10
Heritage™ Handi-Butler Group	25
Heritage™ Home Turbo Group	26
Heritage™ Super Renovation Group	24
Horizontal Handle Position	10
Hose	4, 15, 17
Hose Connector	15

## I

Important Safeguards	6
Instant Suds	27

## K

Kirby Care Kit	27
----------------	----

## L

Limited Warranty	23
------------------	----

## M

<b>Mattress Cleaner</b>	
Converting to	12
Handle	4, 12
<b>Mounting</b>	
Attachments	15
Flexible Hose	14, 15

## O

Odorific	4, 27
Owner Registration	22

## P

Parts List and Controls	3
Power Cord	3, 12, 14, 18, 21
Power Plant	3

## R

Rebuilding Agreement	22
Removing Rug Nozzle	14
Repair and Service	18, 19, 20, 21
Reusable Bag System	3, 8, 9
Room and Carpet Freshener	4, 27
<b>Rug Nozzle</b>	
Belt Replacement	20
Brush Adjustment	19
Brush Cleaning	19
Brush Height	10
Brush Mounting	20
Brush Roll	20
Rug Plate	20
Rug Renovator	24

## S

Safety	6
Sani Em-Tor	8, 9
Sani Pocket	9
Sani Scraper	9
Scuttle	27
Service and Repair	18, 19, 20, 21
Service Tips	18, 19, 20, 21
Shoulder Portable	16
Shoulder Strap	4, 16
Standard Attachments List	4
Stop Latch	3, 10
Storing Flexible Hose	16
Straight Extension Tube	4, 17
Straight Suction Cleaner	11
Straight Suction Cleaner Conversion	11
Surface Nozzle with Swivel Attachment	4, 17
Sweeping Pattern	10
Swivel Attachment	4, 17

## T

Table of Contents	5
Tank Cannister	14, 15
Toe Touch Control	3, 8, 10, 14
Trouble Shooting	21
Turbo Brush	4, 17
<b>Turbo Brush</b>	
Belt Replacement	21
Brush Adjustment	19
Brush Cleaning	19
Turbo Groom	26
Turbo Sander	26

## U

Upper Cord Hook	3
Upright Cleaner	10, 11
Upright Handle	3, 10

## V

Vacuum Cleaner Bag Systems	7, 8, 9
Vacuum Height Adjustment	8, 10, 14

## W

Warnings	6, 8, 17, 18
Warranty	23



**a Scott Fetzer company**

CLEVELAND, OHIO 44102