

More Leisure Time For You

Kirby

Ultra Sanitronic 80

WARRANTY AND INSTRUCTION BOOK

CONTENTS

THIS BOOK . . .

is dedicated to you, the owners of the wonderful new Kirby. It is designed to promote your complete enjoyment of the Kirby Dual Sanitronic 80. Keep this booklet handy. Read and review it often, for by knowing your Kirby completely you will realize full value from your purchase, and appreciate the Kirby as a truly marvelous invention and dependable household friend.

YOUR KIRBY	
What it does for you	Pages 2 to 5
Its components	Pages 6-7
HOW TO USE YOUR KIRBY	
Belt Lifter	Pages 8-12-13
Toe-Touch Control	Page 9
Motor Switch & Handle Lock	Page 10
Sani Em-Tor	Pages 11-17
Handi-Butler	Pages 14-15
Handi-Sharpener	Page 15
Upright Cleaner	Page 16
Suction Relief Vent	Page 17
Duster Buffer	Page 18
Power Polisher	Page 18
Rug Renovator	Page 19
Basic Attachments	Page 20
Spray Gun, Suds O-Gun	Page 21
Portable Units	Pages 22-23
Surface Nozzle	Page 23
Crystalator	Pages 24-25
Roll-O-Waxer	Page 26
Handi-Waxer	Page 31
HOW TO MAINTAIN & SERVICE YOUR KIRBY	Pages 27 to 30
INDEX	Back Cover
KIRBY WARRANTY	Pages 32-33

SEE ALL THE
THINGS YOUR



Dual
Sanitronic
'80'

CAN DO

ON THE
FOLLOWING
PAGES



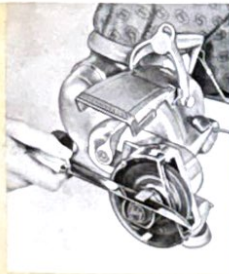

● HANDI-BUTLER
A versatile power tool for the household as well as the man of the house. It sharpens knives, shines and polishes metals.

● CRYSTALATOR
A complete demisting unit. Gives you a quick, easy, safe and sure method of control, through an exclusive method of quick evaporation of para crystals.



● SUDS-O-GUN
Generates volumes of extra dry suds for the safe, efficient and economical shampooing of rugs, tapestries and upholstered furniture.



● SPRAY GUN
Sprays lacquer, paint, insecticide, liquid floor wax, plus many other liquids.

Kirby

Dual
Sanitronic
'80'

no other appliance in the world does as many things for you...



● TANK TYPE CLEANER
Ideal for light dusting and all above-the-floor cleaning.



● HAND PORTABLE
Deep cleans mattresses thoroughly, right on your bed. Wonderful for use on upholstered furniture, too.



● UPRIGHT CLEANER
Exclusive "Triple Cushion Vibration" assures you of the most efficient cleaning action.



● POWER POLISHER
Polishes any hard surfaced floors right up to the base board and into corners without leaving unsightly streaks.



● RUG RENOVATOR
Renovates rugs and carpeting safely, efficiently and economically. Ground in dirt, soil and lint are automatically removed as you shampoo with dry suds.

collectingdust.com

collectingdust.com

PLUS FEATURES

no other appliance is as versatile or gives you so many

collectingdust.com

collectingdust.com

collect

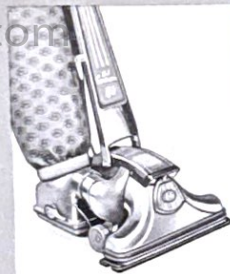

● FLOOR DUSTER-BUFFER

Loosens dirt, buffs and vacuums hard surfaced floors easily and effectively.

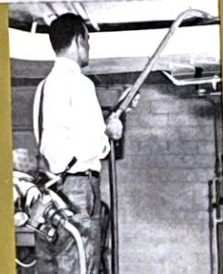

● SHOULDER PORTABLE

Add the shoulder strap to the floor portable and you have a unit which frees both hands for work in difficult places.

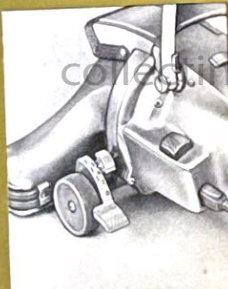

● TOE TOUCH CONTROL

Gives you 8 positive adjustments to assure you the proper cleaning height for all floor coverings.

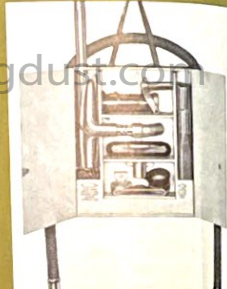

● TOOL CABINET

Designed for your convenience in use and storage. Hung on a door knob or back of a chair — tools are handy for use.



● SANI EM-TOR

An exclusive Kirby feature which makes it easy to empty the filter bag without fuss or muss.



● SANI POCKET (Patented)

Permits you to scrape excess dirt from filter bag into Sani Em-Tor without touching dirt.



● SAFETY SELECTOR SWITCH

For maximum operating efficiency and protection against possible injury, it automatically selects proper speed when attachments are on and disconnects power when fan blades are exposed.



● SWIVELED CORD HOOK

Permits you to release the cord for use simply by turning the cord hook.

for your complete enjoyment

KNOW YOUR **Kirby** PARTS

- | | |
|------------------------|----------------------------------------|
| 1. FILTER BAG | 20. CREVICE TOOL BRUSH |
| 2. FILTER BAG GUARD | 21. DUSTER BRUSH |
| 3. SANI EM-TOR | 22. MASSAGE CUP |
| 4. FLOOR DUSTER PAD | 23. UTILITY BRUSH NOZZLE |
| 5. LONG HANDLE | 24. UTILITY AIR NOZZLE |
| 6. BELT | 25. CRYSTALATOR |
| 7. BRUSH ROLL | 26. SURFACE NOZZLE — SWIVEL ATTACHMENT |
| 8. BELT LIFTER | 27. HANDI-WAXER |
| 9. SUCTION RELIEF VENT | 28. CREVICE TOOL |
| 10. RUG NOZZLE | 29. STRAIGHT EXTENSION TUBE |
| 11. PORTABLE HANDLE | 30. CURVED EXTENSION TUBE |
| 12. HANDI-SHARPENER | 31. SPRAY & SUDS O GUN |
| 13. HANDI-BUTLER | 32. HOSE COUPLER |
| 14. SHOULDER STRAP | 33. FLEXIBLE HOSE |
| 15. HANDLE PIN | 34. SWIVELED COUPLER TUBE |
| 16. POWER POLISHER | 35. RUG RENOVATOR |
| 17. CORD | 36. ROLL-O-WAXER |
| 19. MOTOR UNIT | |

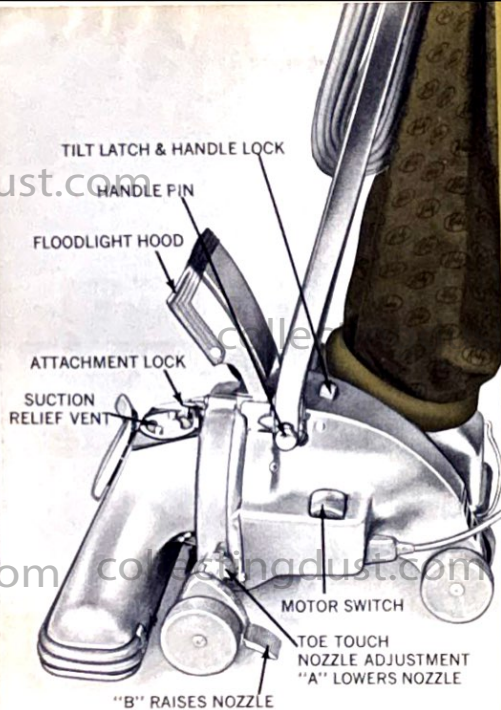
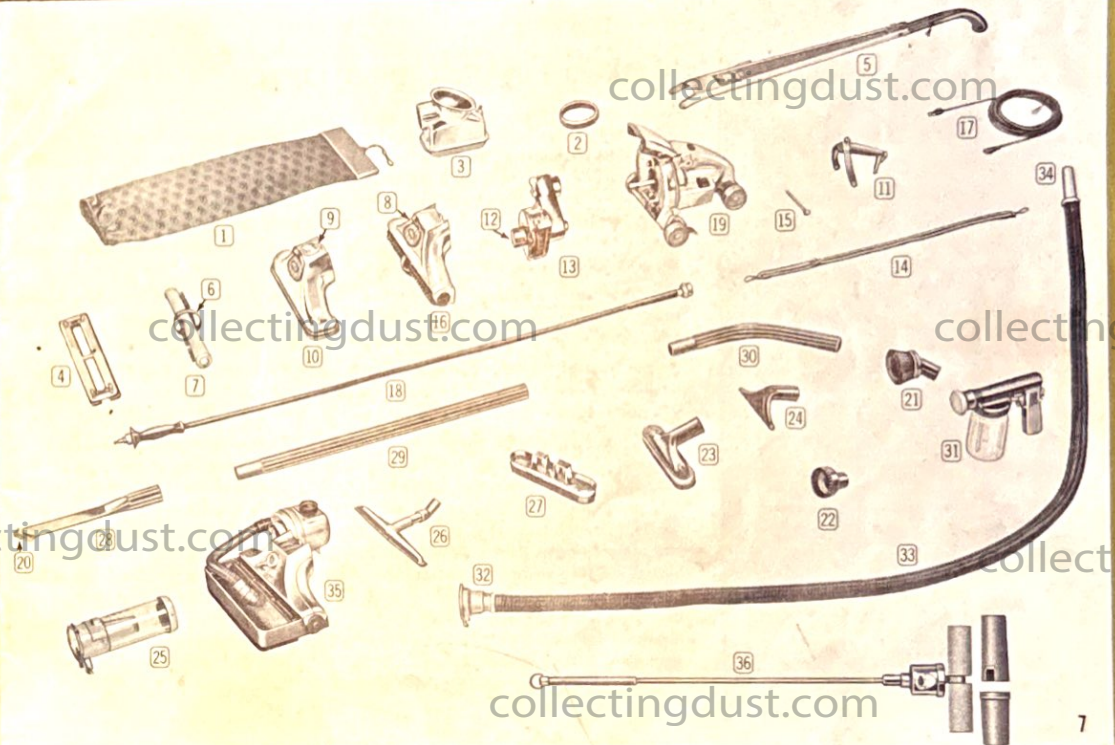

TILT LATCH & HANDLE LOCK

HANDLE PIN

FLOODLIGHT HOOD

ATTACHMENT LOCK

SUCTION RELIEF VENT

MOTOR SWITCH

TOE TOUCH NOZZLE ADJUSTMENT
"A" LOWERS NOZZLE

"B" RAISES NOZZLE

Fig. 1



Fig. 2

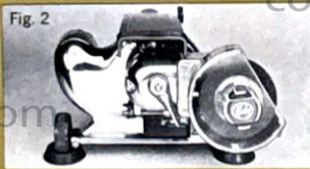

Fig. 3



Fig. 4



MAGIC FINGER BELT LIFTER

Belt lifters are found on the Rug Nozzle, Power Polisher, Rug Renovator and Handi-Butler. The operation of the belt lifter on the Rug Nozzle and Power Polisher are identical. The belt lifter on the Handi Butler differs in appearance only (see figure 2), and is explained in pages 12 and 13. The belt lifter on the Rug Renovator operates the same as the belt lifter on the Rug Nozzle, except that it looks like the belt lifter on the Handi-Butler and is "off" when turned to the lower right and "on" when turned to the lower left when viewed from the front.

The Kirby belt lifter makes it easy for you to change units. The belt transmits power from the motor to the Kirby unit. To change units, the belt must be removed from the belt drive shaft and replaced with the belt of another unit. The belt lifter does this for you.

On the front of the Rug Nozzle and the Power Polisher you will find the Kirby Dual Sanitronic name plate. At the top of this name plate is a lever arm which is used in rotating the plate.

As the first step in lifting the belt for attachment, turn the name plate so the lever arm is upright. (See Figure 4) Then look through the round opening at the back of the nozzle and make certain that the belt is standing upright in the center of the brush. Also check the position of the belt on the brush roll by looking at the bottom of the nozzle. It should be in the center. Then turn the name plate counter clockwise until it stops in position as illustrated in Figure 3. This is the "OFF" position. When the belt is new, it will take a firm pressure to complete the turn. In turning the Belt Lifter to the "OFF" position you automatically pick up the belt on the metal finger and lift it so the Belt Drive Shaft can pass through the loop (See Figure 1) Your nozzle is now ready for attachment to the motor unit (see page 16). Once it is attached turn the name plate clockwise so the lever arm is again upright. This is the "ON" position and the belt will be properly in place on the Belt Drive Shaft.

This exclusive Kirby feature enables you to positively adjust the rug cleaning nozzle to the proper height for efficient cleaning of all floor coverings.

If the nozzle were set too high, there would be no cleaning action. If it were set too low, the cleaning action would be impaired and the machine would be hard to push.

To adjust the Kirby Rug Nozzle properly for your rug, simply depress the large lever (see "B" in illustration) with your toe as far as it will go. This raises the nozzle to the maximum height and the pointer will indicate No. 7 on the adjustment scale.

Now turn on the motor and depress button "A" with your toe. Each time you depress this button the nozzle will lower one notch. Continue to depress this button one notch at a time until you notice a change in the sound of your Kirby. This indicates that the nozzle is at the correct level for the thorough cleaning of your carpet.

If the suction is broken with normal movement of the machine, lower the nozzle one more notch.

This same adjustment mechanism is used when operating the Hand Portable or the Power Polisher.

HOW TO USE THE

TOE TOUCH CONTROL

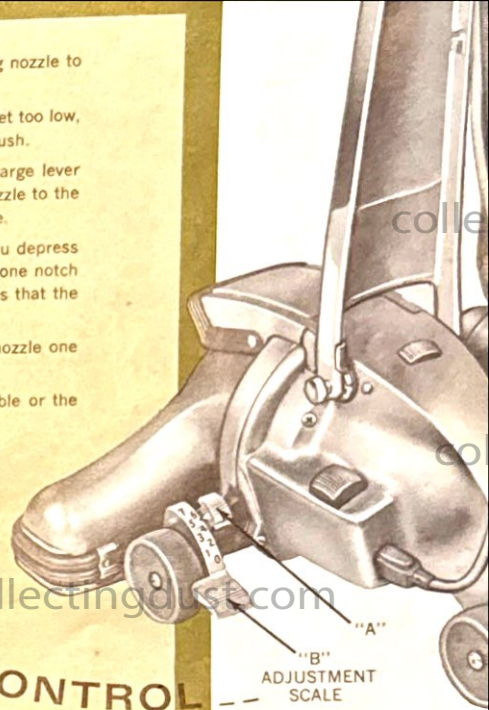



TILT LATCH

This latch permits the long handle to swing in an arc to a point where additional downward pressure raises the Rug Nozzle up and over the edge of rugs, electric cords and other obstructions. This action is accomplished by sliding the Tilt Latch button toward the motor switch side of the machine as far as it will go.

When it is necessary to push the Kirby under low furniture, the handle can be brought to a horizontal position simply by sliding the Tilt Latch button to the extreme opposite position — toward the bag or Sani Em-Tor.

TILT LATCH, HANDLE LOCK, MOTOR SWITCH

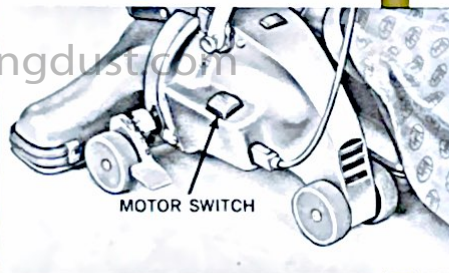

HANDLE LOCK

To lock the handle in the horizontal position for the cleaning of stair treads, etc., simply push the Tilt Latch button towards the switch side of the machine while the handle is in the horizontal position. It may be necessary to maintain pressure on the button as you gradually raise the handle.

MOTOR SWITCH

The Kirby motor is turned on or off by depressing the switch button on the side of the motor unit with either your toe or hand.



ATTACHING THE SANI EM-TOR

The Sani Em-Tor is attached to the neck of the Motor Unit with a simple twist. Detailed instructions can be found on page 17. Before putting unit into operation, be sure plastic bottom is locked securely in place.



HOW TO USE THE SANI EM-TOR

The Sani Em-Tor, with the patented Sani Pocket, is an exclusive Kirby device which enables you to empty the bag right in your home without muss, fuss or expense. The Sani Em-Tor should be emptied after each thorough cleaning. If dirt is allowed to accumulate in the filter bag, the cleaning efficiency of your Kirby will be reduced. It is just good housekeeping to keep the Sani Em-Tor and filter bag empty.

EMPTYING THE FILTER BAG

1. Detach bag chain from handle clip.
2. Lower Rug Nozzle to No. 0 position (See page 9) and turn on motor.
3. Allow motor to run briefly and then turn off. While bag is still extended, shake it vigorously from the top.
4. Spread newspaper on the floor and place Kirby on it.
5. Tilt machine slightly and lift lock lever on the side of Sani Em-Tor to release plastic bottom.
6. Swing bottom tray out from under Sani Em-Tor and turn it upside down, emptying the dirt and lint onto the paper.
7. After all dirt has been removed, swing plastic bottom back into place and lock securely with locking lever.

If excessive dirt and lint has accumulated in the bag, and does not fall readily into the Sani Em-Tor, use the following procedure.

1. Open zipper at rear of bag and place hand into patented Sani Pocket, grasping Sani-Scraper at bottom.
2. Scrape sides of bag with Sani-Scraper in downward strokes.
3. Using Sani-Scraper, push excess lint and dirt into Sani Em-Tor.
4. Empty as in "5" through "7" above.



HANDI-BUTLER

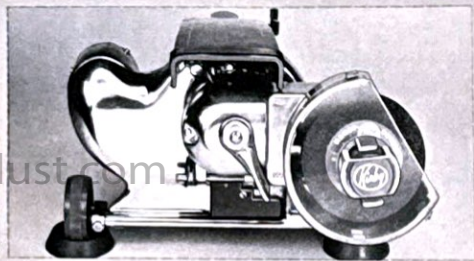

Fig. 1

On the front of your Handi-Butler you will find a lever which can be rotated between "ON" and "OFF" positions. This is the Belt Lifter for the Handi-Butler.

STEP 1: Set the lever in the "ON" position and by looking through the round opening at the back make sure the belt is over the metal finger. If it is not in place, use a lever such as a screwdriver to slip the belt over the finger.

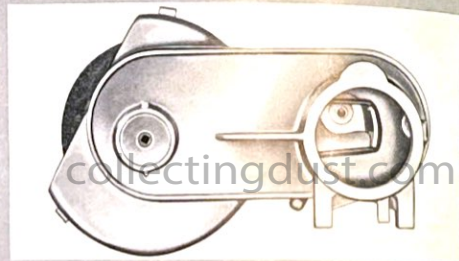

Fig. 2

STEP 2: Turn the Belt Lifter lever to the "OFF" position thus extending the belt (figure 2). The unit is now ready for attachment to the Motor Unit.

STEP 3: Raise the Floodlight Hood. Hold the Handi-Butler so the Attaching Slot is on the Attaching Bar which is just below the Belt Drive Shaft. (Figure 3). The Belt Drive Shaft should enter the large round opening and pass through the loop formed by the belt.

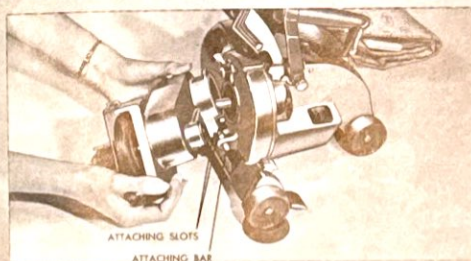

Fig. 3

STEP 4: The unit should then be swung back against the Motor Unit and at the same time a slight downward pressure should be applied to bring the other Attaching Slot into position on the Attaching Bar.



Fig. 4

While holding the unit in place, turn the Attachment Lock Lever to hold the unit in place (figure 4).

STEP 5: Turn the Belt Lifter Lever to the "ON" position and the unit is ready for operation. Rubber cups, which are provided, should be placed under the front wheels to steady the unit (figure 3).

HOW TO USE THE

HANDI-BUTLER

THE ASSEMBLY OF WORK WHEELS

The grinding wheel, wire brush and buffing wheels may be attached to either the Handi Butler itself, or the flexible shaft. The sanding disk and lambswool pad will attach to the flexible shaft only. To attach to the Handi-Butler, grasp the wheel by the finger grip and insert the wheel shaft into the drive shaft opening. The magnetic clutch will hold the wheel firmly in place. To remove, grasp the wheel by the finger grip and pull firmly away from the drive shaft. To attach to the flexible shaft, attach the drill chuck to the end of the flexible shaft. Insert the wheel shaft into the chuck and tighten. The drawings on the right show typical assemblies and, in the case of the work wheels, the same sequence is followed with each.

ATTACHMENT OF FLEXIBLE SHAFT

To attach the Flexible Shaft, grasp the knurled collar of the bayonet connection and insert the core wire into the small hole at the rear of the Handi-Butler housing. Align the slots in the collar with the pins in the housing and with a firm forward pressure, twist to the right. When released the connection will lock firmly

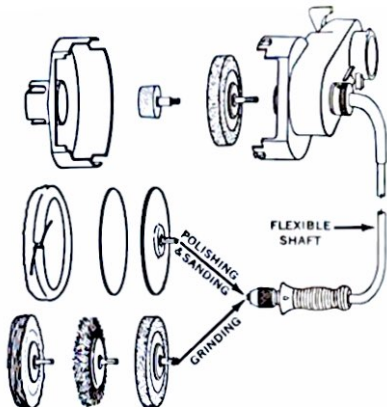

in place. A slight rotation of the Handi-Butler drive shaft may be needed to permit the core wire to engage with the drive shaft.

Caution should be taken to be sure the hand grip of the shaft is held in the hand whenever the power is on.

With the addition of a shaft locking button, it is no longer necessary to use pliers or a wrench when tightening or loosening the chuck. Simply press the small shaft locking button into one of the slots in the flexible shaft handle face plate. This holds the shaft, while tightening or loosening the chuck, as a wrench would.

WHEEL GUARD COVER

The Wheel Guard Cover is attached to the Handi-Butler housing by sliding its edge under the spring clips on the housing. Use this cover for your protection whenever using the work wheels or the Handi-Sharpener. The guard may also be removed from the housing, rotated 180° and re-attached. This provides maximum protection from the grinding wheel while the Handi Butler is in use as a shoulder portable unit or as a knife sharpener. See use of the Handi-Sharpener on page 15. Abuse of this cover can result in breakage which is not covered by the warranty.

HOW TO USE THE HANDI-SHARPENER AND "MAGIC FINGER" BELT LIFTER



POLISHING AND BUFFING

The lambswool polishing pad is stretched over the rubber disk and fastened by drawing the strings tight and tying. Be sure to tuck the loose ends under the edge of the pad. It is not necessary to have the sandpaper disk in place as the drawing, left, might imply. This pad is ideal for polishing waxed surfaces such as your table tops.

Your buffing wheels can help you restore the luster to your silverware or other decorative metal objects around your home. The sheeting buffing wheel is used with the red polishing compound No. 1 to polish brass, copper, or similar metals. The flannel buffing wheel is used with the light-colored polishing compound No. 2 to polish precious metals such as gold or silver. The polishing compounds are applied by holding the stick against the rotating wheel.

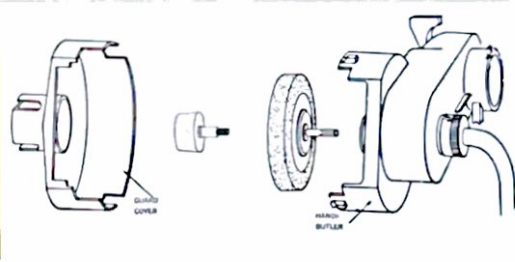

HANDI-SHARPENER

Your Handi-Sharpener is assembled and ready to use when you receive it. If it becomes necessary to replace the knife sharpening wheel, simply unscrew it from the grinding wheel. Replacement wheels can be obtained from your Kirby dealer.

The preferred method of sharpening a knife is as follows: Remove the plastic wheel guard, rotate 180° and replace. The rim of the plastic wheel guard will cover the large grinding wheel and eliminate the possibility of accidental contact. Hold the knife to be sharpened in your right hand, using the left hand to assist in steadying the knife handle. Insert the knife blade at the handle end into the top slot and guide it back and forth, keeping the edge of the blade against the grinding wheel. Now sharpen the other side of the knife by inserting the blade into the bottom slot and repeating the operation.

ASSEMBLY INSTRUCTIONS

HANDLE ASSEMBLY — SWIVEL CORD HOOK WRENCH

Your long handle is shipped in two pieces and will be assembled at time of purchase by your Kirby dealer.

Should you ever want to take it apart, just pull out on the top swivel cord and hook (against spring pressure) to engage swivel cord hook wrench. By turning counter-clockwise, you will loosen handle grip so that it can be removed.

The same procedure can be used to tighten handle grip if necessary by turning swivel cord hook clockwise.

16

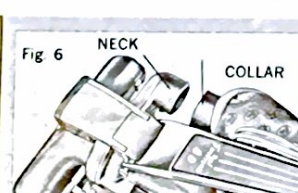
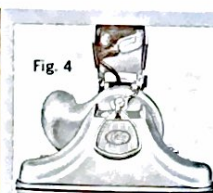
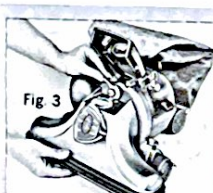
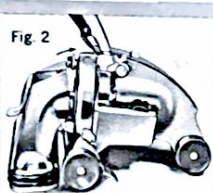
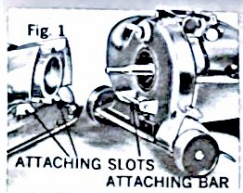

UPRIGHT CLEANER

The following units should be attached to the Motor Unit for use as an upright rug cleaner: Rug Nozzle, Long Handle, Sani Em-Tor and Bag.

ATTACHMENT OF RUG NOZZLE

STEP 1: Set Belt Lifter on Rug Nozzle for attachment as explained on page 8.

STEP 2: Set Toe-Touch Nozzle Adjustment at No. 7 position on Adjustment Scale (See instructions on page 9). Raise Floodlight Hood.

STEP 3: Place Attaching Slots at back of Rug Nozzle on the Attaching Bar. (see figures 1 and 2). Swing nozzle back toward Motor Unit with a slight downward pressure so as to depress the Safety Switch Slide (see figure 2). Hold nozzle in place with one hand and lock in place with Attachment Lock Lever at top front of Motor Unit. (see figure 3).

STEP 4: Turn Belt Lifter to "ON" position (figure 4).
To remove nozzle reverse these steps. Be sure to have Belt Lifter in "OFF" position before releasing attachment lock lever. (See figure 3).

ATTACHMENT OF LONG HANDLE

STEP 1: Remove Handle Pin from Motor Unit by pulling straight out with a slight twisting action.

STEP 2: Insert the fork of the Long Handle into the slide at top of Motor Unit (see figure 5).

STEP 3: Replace Handle Pin as far as it will go.

ATTACHMENT OF SANI EM-TOR

STEP 1: On the inside of the Sani Em Tor collar you will notice three curved slots. These should be lined up with the pins on the neck of the Motor Unit.

STEP 2: Slide the collar firmly over the neck and twist downward. The unit will lock firmly in place. (See Figure 6).

When the unit is new the rubber gasket inside the collar of the Sani Em-Tor will be stiff and offer some resistance. This gasket is necessary to give you an air-tight seal.

To remove the Sani Em-Tor simply twist from the bottom and away from the Motor Unit. It will unlock with a snap.

SUCTION RELIEF VENT

Turn vent plate clockwise to open. When open, it is easier to clean efficiently long pile cotton or synthetic carpets and light weight throw rugs. Vent should be closed for normal, full power cleaning operations, and when emptying bag. See page 6 for location.

ATTACHMENT OF FILTER BAG AND CORD

Plug the cord into the rear of the Motor Unit just below the Motor Switch. Fasten the cord hook to the clip just below the Handle Grip and wind down under the lower cord hook and up over the Swiveled Cord Hook. (Figure 7). Fasten the bag chain to the other side of the double clip.

17

HOW TO USE THE

DUSTER-BUFFER

With the Kirby assembled as an upright rug cleaner, snap the Floor Duster Pad into place by inserting the spring clips into the rug guard on the bottom of the Rug Nozzle. Adjust the Toe Touch Nozzle Adjustment until the Floor Duster Pad is just touching the floor. Turn the Belt Lifter to disengage brush, turn on the motor, and you are ready to buff-dust hard surfaced floors.

POWER POLISHER

Assemble the Kirby as an upright machine (See Pages 16 & 17) with the exception of the Rug Nozzle. In its place attach the Power Polisher Nozzle. Attachment procedure is the same as for the Rug Nozzle (See Page 16).

Apply wax to the surface to be protected. Polishing can be done immediately after applying Kirby Wax — no drying time is required for Kirby Wax — as other waxes may require. Set the Toe Touch Nozzle Adjustment to the lowest or "0" position (See Page 9) so the front wheels do not touch the floor. Set handle in normal cleaning position. Turn on the motor and the polisher Brush will quickly polish your waxed floor to the highest possible luster. The best polishing results will be obtained when the polisher is resting on the rear wheels and the polisher brush.

By pushing the handle down against the Tilt Latch (See Page 10) it is possible to raise the brush and easily polish a six inch baseboard.

When storing the Power Polisher Nozzle, be sure to turn the Belt Lifter to the "ON" position. If you don't, the belt will become stretched and useless.

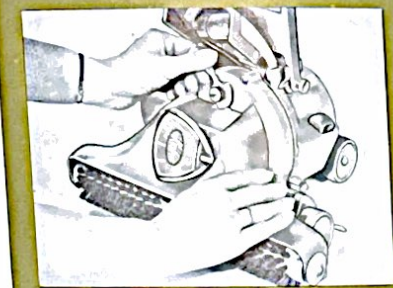
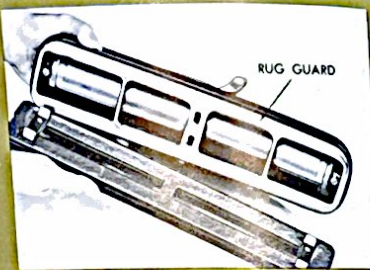

HOW TO USE THE RUG RENOVATOR

Before shampooing rugs or carpeting with the rug renovator, the entire area to be renovated must be thoroughly vacuumed using the Kirby Upright.

Remove the rug nozzle, Sani Em-Tor and bag from the Kirby. The renovator tray attaches to the nozzle assembly (fig. 1) by sliding the renovator tray into the slots at each end of the nozzle assembly. Turn the belt lifter to "off" position and attach the renovator nozzle to the front of the Kirby motor unit the same way you attached the rug nozzle. (See Upright assembly instructions page 16.)

Attach the renovator tank to the neck of the Kirby, as you did the Sani Em-Tor, making sure the sponge like filter is in place. (See attachment of Sani Em-Tor page 17.)

Insert end of hose with grommet fitting, into hole in the center of the renovator tray. Slip other end of the hose over the tank discharge.

Fill the tank with warm water to "fill line" (1 qt.) and add 2 oz. or eight caps full of Kirby Instant Suds, using the bottle cap of the Instant Suds as a measure. One tankful of solution should be sufficient to clean an area approximately 9 x 12 ft.

To adjust the rug renovator to the proper height for shampooing your rug or carpeting, depress the toe touch control as far as it will go. This raises the lever to the maximum height and the pointer will indicate No. 7 on the adjustment scale. Lower the rug renovator a step at a time by depressing the toe touch control. Check for proper height by moving unit back and forth at each level of adjustment. Lower until brush gives a slight drag on carpet or rug. You are now ready to begin the shampooing operation.

Start the Kirby motor. Shampoo suds will start to flow down the transparent hose through renovator tray to the rug. Push and pull the unit slowly back and forth with overlapping strokes. A layer of suds the entire width of the tray will be seen on the back stroke of the rug renovator if the height is properly adjusted. If suds accumulate in front of tray, move the unit faster, if width of suds left on rug is not as wide as the tray, move unit slower. The dirt and spent suds will be deposited in the tray, the rug surface will be slightly damp after shampooing, and some residual light suds may remain. Rug protector pads furnished must be placed under all legs of furniture to protect against rust stains.

When the surface has become dry, the residue will turn to a dry powder, which can be easily removed and the nap of the rug restored by a thorough vacuuming with the Kirby with rug nozzle attached.

CLEANING... It is important for good operation that the rug renovator be cleaned after each use.

Remove the hose from the tank. Remove the tank from the neck of the Kirby motor unit, then remove the air filter and slip the Suds O-Screen off of the tank. Rinse the sponge filter and Suds O-Screen under running water. Remove the tray and nozzle assembly from the motor unit. Release the belts from the belt lifter and remove the renovator nozzle from the tray. Rinse the tray under a water faucet to remove the dirty suds and lint, being careful not to saturate the brush. Open the hinged shelf and remove the dirt and lint. Shake any excessive water from the brush before re-using or storing the unit.

When storing the rug renovator, be sure the belt is not left up on the belt lifter hook. Leaving the belt on the belt lifter hook will cause the belt to stretch and render it useless.

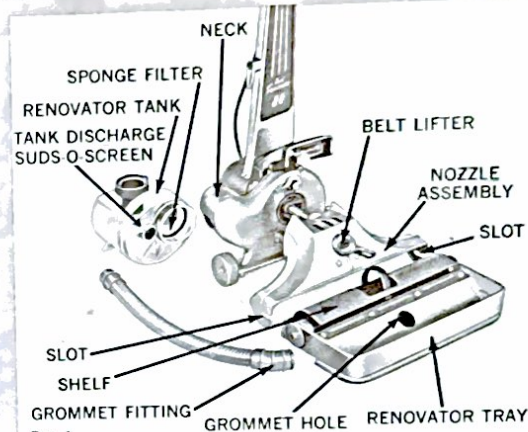
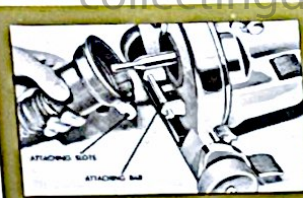

Fig 1

HOW TO USE THE BASIC

ATTACHMENTS

The Kirby hose furnished with your standard set of attachments is designed for direct connection to either the "intake" or "blower" side of the Kirby motor unit, by means of the universal coupler attached to the hose.



ATTACHING HOSE TO "INTAKE"

Place the attaching slots of the hose coupler over the attaching bar at the front of the motor unit. Swing the hose coupler back against the motor unit and lock in place with the attachment lock lever. To do this, a slight downward pressure should be applied, so as to depress the speed selector switch.



ATTACHING HOSE TO "BLOWER OUTLET"

The hose is connected to the "Blower Outlet" by placing the hose coupler over the neck or blower end of the motor unit and pushing it into place with a clockwise twist. It will lock into position. When using the Kirby in this fashion, it is necessary to attach the Crystalator to the front (intake) of the Kirby motor unit. (Detailed instructions on page 24.)



BAG ATTACHMENT FOR PORTABLE UNITS

Sani Em-Tor and bag are attached as explained on page 17. Bag is then folded under and bag chain hooked to the clip at the back of Portable Handle.



THE PORTABLE HANDLE and SHOULDER STRAP

Remove Handle Pin and Long Handle. Slide legs of portable handle into place on top of the Motor Unit as illustrated. Replace Handle Pin. The Shoulder Strap is hooked to the loops provided at top and rear of handle.

HOW TO USE THE **SPRAY-GUN** **SUDS-O-GUN**

THE SPRAY GUN

Assemble the floor portable or shoulder portable unit as instructed on pages 22 and 23, except that the flexible hose is connected to the blower outlet or neck of the motor unit in place of the Sani Em-Tor. The Spray Gun is attached to the hose with a firm twist.

Paints should be thinned for spray application as instructed on the can. To fill the Spray Gun jar, unscrew from unit and fill about three-fourths full. Avoid over filling to prevent spillage in use. An extension tube is provided inside the supply tube which can be extended for larger jars. Screw jar back in place firmly.

Turn on motor and adjust to proper spray. Turning the button at the rear of the gun clockwise makes the spray finer. Pull trigger with index finger to spray.

The gun may be quickly cleaned after use by spraying a solvent or paint thinner through the gun using a clean jar. If necessary the entire assembly may be taken apart by removing the valve stem valve seat and immersing these parts in solvent. Spray gun parts are not harmed by ordinary solvents or thinners.

THE SUDS-O-GUN

Assemble Spray Gun as explained above, and place Suds O Gun cap over the front of spray gun — a clockwise twist will do it.

Mix Kirby Instant Suds as directed on bottle, and fill jar about three-fourths full. Adjust gun to a very fine spray. A volume of very dry suds will then be produced. Suds can be spread directly on surface to be cleaned or gathered in a basin.

The suds should be worked into the surface with a brush or sponge until they disappear. Allow a few minutes for surface to dry thoroughly and vacuum with appropriate nozzle to remove the dry froth which now contains the grime and dirt.



*Caution: When using paint or inflammable liquid, keep away from open flames.

PORTABLE UNITS

HAND PORTABLE

This is a powerful unit which will do a magnificent job of cleaning your deep cushions and stair treads. It is especially suited for use on your mattress.

To assemble, attach the following to the Motor Unit: Rug Nozzle (See Page 16). The Portable Handle (Page 20). The Sani Em-Tor (Page 17). Hook the Bag Chain to the clip on the Portable Handle and with the Toe Touch Nozzle Adjustment (Page 9) set the nozzle height at the position most suitable.

SHOULDER PORTABLE

This unit is ideal for cleaning large areas where considerable mobility and freedom of hands are advantages. It is also convenient to use with the Handi-Butler and Flexible Shaft. Assemble the following to the Motor unit: Flexible Hose, or Handi-Butler and Flexible Shaft (See Page 20 or 12, 13 & 14), Sani Em-Tor and filter bag (Page 17), and the Portable Handle and Shoulder Strap (Page 20)



FLOOR PORTABLE OR TANK TYPE CLEANER WITH SURFACE NOZZLE

This is a unit which gives you the light weight portability of a tank-type machine for above the floor cleaning operations around your home. Used with various combinations of the tools and extension tubes, you can clean those hard to reach areas in your home with ease. To assemble, the following should be attached to the Motor Unit: Sani Em-Tor and Bag, Suction Coupler, Flexible Hose, and appropriate extension tubes and tools. For complete portability, remove the Long Handle and replace it with the Portable Handle.

Extension tubes and tools are connected simply by inserting the tapered end of the hose or tube into the tool with a firm twist. To release simply twist and pull. A straight pull will not separate the parts if they have been properly assembled.

THE SURFACE NOZZLE

This nozzle has been designed to facilitate the surface cleaning of carpets and hard surfaced floors under your low furniture, and for dusting of all hard surfaced floors. It will not deep clean your carpets as well as the Kirby Floor Nozzle with Triple Cushion Vibration. However, it will do as good a job as any straight suction nozzle available.

For cleaning carpets, flip brush adjustment lever on front of nozzle to left, so word "UP" appears on lever. This raises the brush to the proper height for carpets. For cleaning hard surfaced floors, flip the lever so word "DOWN" appears on the lever, thus adjusting the brush to the proper height for bare floors. The following is a listing of recommended lever settings for the various types of cleaning you may encounter with your Kirby surface nozzle.

UP

Bare floors—dust only
Deep pile rugs
Cotton loop rugs

DOWN

Bare floors—imbedded dirt
Bare floors—lint and fuzz
Short pile rugs



HOW TO USE THE

CRYSTALATOR

FILLING THE CRYSTALATOR

Pull the cap off the body of the Crystalator. Pour in Paradichlorobenzene Crystals (moth crystals) until Crystalator is about half full when held in a horizontal position. A finger inserted into the inner cone will close the slot and prevent spillage. Replace cap and turn to desired setting: "GAS" for demothing a closet or other confined area; "MEDIUM CRYSTALS" for furniture, baseboards, carpets, etc.; "FULL CRYSTALS" when it is desirable to deposit large crystals in chests or storage boxes. Check the position of the air vent slide cover on top of the Crystalator barrel. With the vent slide cover in the closed position, the unit is now ready for operation.

ATTACHING THE CRYSTALATOR

Place the attaching slots of the Crystalator over the attaching bar at the front of the motor unit. Swing the Crystalator back against the motor unit and lock in place with the attachment lock lever. To do this, a slight downward pressure should be applied so as to depress the speed selector switch.

Note: The air vent slide cover on top of the barrel of the Crystalator should always be left in the open position to allow maximum air passage, except when using the demothing system. Then it must be closed.

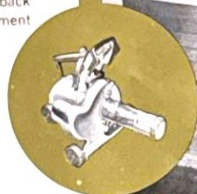

USE WITH HOSE

Assemble the Crystalator Unit as described on the preceding page and also attach the hose and the crevice tool to the blower outlet. See illustration at the right. The crevice tool brush should be removed by squeezing the wire together at the point where it enters the tool and pulling straight out.

DEMOTHING A CLOSET

Assemble the Crystalator Unit as described above and, without attaching the hose, place the unit on the floor of your closet. Turn the Crystalator cap to the "Gas" position, turn on the motor, and close the door. It is advisable to seal the crack at the floor with a throw rug. Allow the motor to run for from 5 to 15 minutes, depending on the size of the closet.

If Crystals cling together, they tend to stop the action of the Crystalator. If this happens, just place your hand over the holes in the top of the Crystalator body for a second while the motor is running. This will loosen the crystals and start them flowing into the fan chamber where they are exploded into a moth killing gas.

CAUTION:

Follow directions and cautions on label of crystal container. Keep crystals out of reach of children. Crystals may be harmful if taken internally. Do not breathe the concentrated gas from the Crystalator. Do not enter a treated closet until it has been ventilated. Do not remain in a treated room until gas concentration is reduced to safe level. If eye, throat or skin irritation occurs, do not remain in treated area. Return unused crystals to closed container and seal tight. In the crystalator, use only 100% pure paradichlorobenzene with U.S.D.A. registration number in the Crystalator.

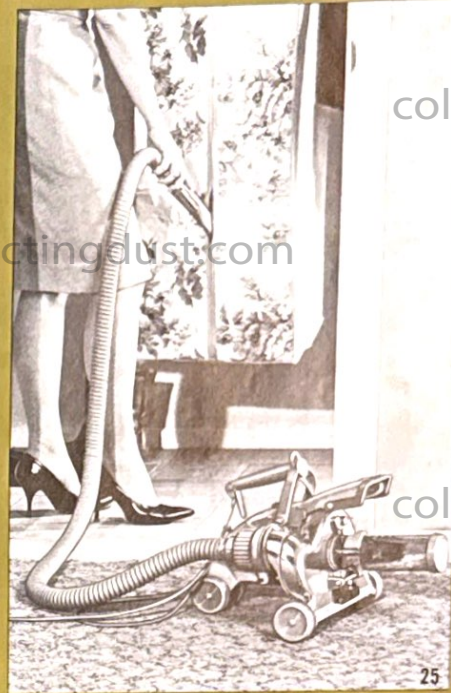

ROLL-O-WAXER

HOW TO LOAD IT

1. Unscrew the Roller Head from the Pressure Cylinder by holding the Roller Head, in plastic covers, with your left hand and turning the Pressure Cylinder counter-clockwise with your right hand. Grasp Pressure Cylinder in label area.
 2. The Kirby Roll-O-Waxer cartridge has been designed for easy insertion or replacement. After clipping the end of the protruding "nipple", insert the opened "nipple" of the Roll-O-Waxer Wax cartridge into the orifice leading to the roller axle. Simple instructions for this process are supplied on each cartridge package.
- Insert a new Kirby Roll-O-Waxer bag of wax into the Pressure Cylinder.
3. Re-assemble the Roller Head to the Pressure Cylinder by turning clockwise.

HOW TO USE IT

1. Remove the protective plastic covers from the Roller Head with a slight twist and pull.
2. Roll the Roller Head over the floor as you would a paint roller. Make overlapping strokes of about 3 feet in length. Use gentle pressure and let the Roll-O-Waxer do the work.
3. To start or increase the feeding of wax to the Roller Head, rotate the Magic Wand handle clockwise. Each

time you rotate the handle one turn you will feel and/or hear a "click". One "click" is usually required for each 9 square feet of floor. Do a section at a time, so that you will not have to walk on a waxed area when polishing. A thin coat of wax evenly applied is most desirable. Do not be concerned if streaks appear when applying wax because the buffing action of the Power Polisher will spread the wax evenly.

4. After a few minutes drying time, depending upon temperature and humidity, you are ready for polishing with your Kirby Power Polisher. Polishing in two directions — longwise and across wise — will enhance and give added lustre to the floor.
5. Always replace the Roll-O-Waxer protective plastic covers and lock them together after each use, so that the wax in the Roller Head will remain fresh.
6. When red signal can be seen through the reload signal opening in the handle, or when you are unable to turn the handle, the wax in the Pressure Cylinder has been used up and the Pressure Cylinder must be reloaded.
7. Avoid storing the Roll-O-Waxer in a hot, dry place.
8. Use your Roll-O-Waxer frequently — every week or two. The more frequently it is used, the better it operates.
9. Keep Roll-O-Waxer charged with wax.

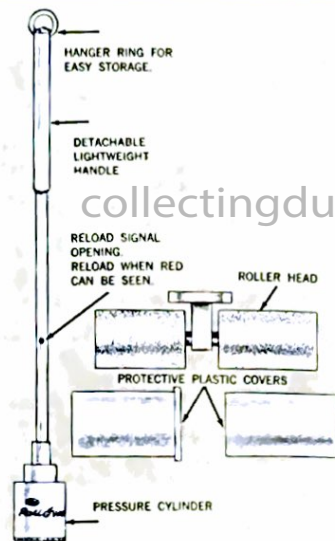

IMPORTANT

Be sure to use only the special Kirby Roll-O-Waxer bags of Brazilian Carnauba Tree Wax, Kirby Handi-Wax or other makes of paste wax should not be used, since these waxes will not flow freely through the Roller Head. If any wax other than the special Kirby Roll-O-Waxer wax is used, it will require complete disassembly and thorough cleaning to recondition the Roll-O-Waxer, and the usual guarantee will be null and void.

If Kirby will not pick up lint or ravelings on carpet, check to see if

1. Belt Lifter is in "OFF" position (Page 8)
2. Belt is broken or worn out (Page 29)
3. Brush needs adjustment (Page 28)
4. Toe Touch Nozzle Adjustment is improperly adjusted (Page 9)
5. Filter bag needs emptying (Page 11)
6. Brush needs cleaning (Page 28)

If motor will not run but floodlight lights up

1. Make sure either the rug nozzle, Crystalator, Handi-Butler, Power Polisher, or hose is properly in place on the front of the motor unit.

If motor will not run and light does not light

1. Check to make sure cord is properly plugged into the machine and wall outlet.
2. Make sure there are no breaks in cord. Check by attaching to a floor-lamp and flexing back and forth along entire length of cord. Pay particular attention to male and female connectors at ends of cord.

If Rug Nozzle is loose even after proper attachment

1. Attachment lock not turned tight enough.

If Sani Em-Tor (Dirt Trap) is loose

1. Check to be sure it is locked in position by turning clockwise as far as possible. (Page 17)

2. Check to see if rubber gasket inside collar of Sani Em-Tor is properly in place. If not, call for service.

If Power Polisher Brush will not revolve

1. Make sure Belt Lifter is in "ON" position.
2. Check condition of belt — replace if necessary. (See Page 29)
3. Make sure belt is not wet with wax.

If Handi-Butler work wheels will not revolve or stop under light pressure

1. Make sure Belt Lifter is in "ON" position.
2. Check belt and replace if broken, worn or stretched. (See Page 29)

If motor runs but light does not light

1. Check bulb for tight fit.
2. Bulb burned out — replacement needed.

If dirt will not fall out of bag and Sani Em-Tor

1. Too much dirt has been allowed to accumulate and it is jamming the large opening of the Sani Em-Tor where the bag is attached. Use Sani-Scraper in Sani-Pocket to clean bag and force dirt into Sani Em-Tor.

If Kirby is hard to push when Rug Nozzle is attached

1. Toe Touch Nozzle Adjustment set too low. Raise one or two notches. (Page 9)

BRUSH ADJUSTMENT AND CLEANING

Through usage, the revolving brush in the rug nozzle will gradually wear down. When it fails to protrude approximately $\frac{1}{16}$ inch beyond the stainless steel rug guard — check by laying a flat piece of stiff cardboard across a portion of the rug guard — turn the brush roll adjustment screws at each end of the brush roll clockwise with a screwdriver until the proper amount of bristle protrudes. Be sure to turn each screw an equal amount so the same amount of bristle protrudes on each end of the brush roll.

TO REMOVE BRUSH ROLL FROM RUG NOZZLE

1. Remove nozzle from motor unit.
2. Turn Belt Lifter to "ON" position.
3. Swing Rug Guard from nozzle on hinges as pictured.
4. Spread support brackets by bending slightly away from Brush Roll. The brush may then be removed for cleaning.
5. Use scissors to cut string, thread or hair which may be wrapped around the brush roll. An old comb is also useful in removing foreign matter embedded in brush tufts.

REPLACEMENT OF BRUSH ROLL

1. Place ends of Brush Roll into support brackets — one end is wider than the other so it can be replaced only the correct way.
2. Bend the support brackets back into place.
3. Make sure belt is positioned in center of Brush Roll.
4. Swing Rug Guard back into the nozzle — it will snap into place. It will be necessary to depress the belt slightly as this is done.



BELT REPLACEMENT

RUG RENOVATOR

Remove the renovator nozzle assembly and the tray assembly from the motor unit. Release the belt from the belt lifter and remove the renovator tray from the nozzle assembly. Remove the screw and plastic bumper from both sides of the tray using a Phillips screwdriver. The brush is now free of the tray and a new belt will slide over the brush roll. Replace the brush in the tray and line up the axle with the screw holes. Replace bumpers and tighten screws securely.

GENERAL INSTRUCTIONS

A belt in good condition is essential for the efficient operation of the Kirby Rug Nozzle, Power Polisher, Handi-Butler and Rug Renovator. If any of these units fail to perform properly, the belt should be examined and replaced if it has become worn, stretched or broken.

The Kirby belt transmits the power from the motor to the Brush Roll of the Rug Nozzle and the Power Polisher, Rug Renovator, and to the work wheels on the Handi-Butler. Therefore, a belt in good condition is essential for the efficient operation of these units.

RUG NOZZLE

If the Rug Nozzle fails to remove lint from the surface of the carpet or to properly vibrate the carpet, the cause of the difficulty may be a weak or broken belt.

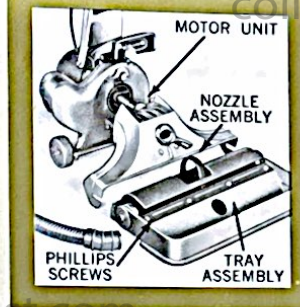

POWER POLISHER

Remove the Power Polisher from Motor Unit and turn Belt Lifter to "ON" position. Loosen the screw at one end of the nozzle about $\frac{1}{2}$ to full turn with a Phillips screwdriver. Remove the screw and rubber bumper from the other end. Swing the Brush Roll out slightly being careful not to bend axle or remaining screw. Slide worn belt off open end. Replace with a new one. Swing brush back into nozzle, line up axle with screw hole and replace screw and bumper. Tighten both screws.



To replace the Rug Nozzle belt, remove the nozzle from the motor unit and remove the Brush Roll from the Rug Guard as explained under Brush Cleaning on page 28. The worn belt can then be slid off over the end of the brush roll and replaced with a new one.

HANDI-BUTLER

1. Remove Handi-Butler from motor unit.
2. Remove work wheels and washers.
3. Turn Belt Lifter to "ON" position.
4. With screw driver slide belt off Belt-Lifter finger.
5. Remove belt by sliding it out over drive shaft to which work wheels are attached.
6. Replace new belt by reversing above steps.

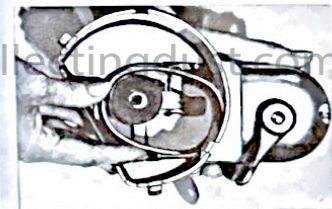



BULBS • CORD • FILTER BAG • LUBRICATION

LUBRICATION

Your Kirby motor has been properly lubricated at the factory and should not need additional lubrication for several years. Lubrication should be done only by an authorized Kirby Serviceman. All other bearings are permanently lubricated and will need additional lubrication only after extreme use.



FILTER BAG MAINTENANCE

Keep the plastic bag guard in place around the point where it is fastened to the Sani Em-Tor. This will minimize wear, and under average use your bag will last for many years. The only time it will need replacement will be at times of general overhaul. The bag is fastened to the Sani Em-Tor with a strong spring and reasonable strength and skill is required for its replacement.



BULB REPLACEMENT

Lift lamp and remove old bulb by depressing and turning bulb counterclockwise. It is a bayonet type base and replacement is made by sliding small lugs on base of bulb down into slots in socket with a firm downward pressure and a clockwise twist. The bulb will lock into place.



KIRBY WAX WITH KGF-40

Kirby Emulsion type paste wax is especially designed for ideal use with the Kirby Power Polisher. This completely new concept in floor wax gives you all the qualities of a hard, long lasting, slip resistant wax plus a proven germ-fighting additive that cannot be incorporated in any mineral spirit, kerosene, or turpentine type of wax. This wax can be polished immediately after application — safe to use on any type of linoleum, asphalt tile, vinyl tile, rubber tile, cork tile or wood floor.

Refill packages containing two half pound pouches are obtainable from your Kirby dealer.

The Kirby Handi Waxer is designed to fit your Kirby extension tubes, and provides a wide swath applicator in a convenient size package. A plastic cover of inert and flexible material prevents the wax from drying out when not in use. Each waxer contains a 1/2 pound package of Kirby Emulsion Wax.

To use the waxer, slit the wax pouch with a sharp knife through the slot in the felt bottom face. The wax will feed into the felt when pressure is applied on the extension tube. Convenient step pads are provided on the waxer to enable you to increase the pressure on the wax if normal applying pressure from the extension tubes is not sufficient.



KIRBY INSTANT SUDS WITH KGF-40

Now you can clean carpets, upholstered furniture and other household articles with volumes of extra dry suds and help to make them safe against air and dust borne bacteria. For cleaning carpets and rugs, set up the Kirby for Rug Renovator operation, fill tank with warm water to "fill line" (1 qt.) and add eight caps full of Kirby Instant Suds using the bottle cap of the Instant Suds as a measure. Eight caps full equal approximately two ounces of Kirby Instant Suds. For cleaning upholstered furniture and other household articles, set up the Kirby for Spray Gun operation and mix three caps full of Kirby Instant Suds with 3/4 jar full of lukewarm water. Attach the Suds O-Gun screen to the front of the Spray Gun. Using a fine setting of the adjustment screw, you can make a tremendous volume of suds from a small amount of liquid. Direct the suds into a bowl, or over a small area of the surface to be cleaned, and brush suds into the surface until the suds disappear. After drying, remove the residue (which now contains the dirt) by vacuuming with your Kirby Kirby Instant Suds comes in an unbreakable 12 ounce plastic bottle, and full directions are included on the label. This combination of cleaning power, resoling resistance, mildew prevention, fabric brightener and germ fighting action makes Kirby Instant Suds with KGF-40 unique.



KGF-40 CONCENTRATE WITH DEODORANT

Here at last is a means of fighting infectious air borne bacteria in your home. Kirby KGF-40 concentrate enables you to do this simply and effectively. Set up your Kirby for spray gun operation. Mix 3 caps full of KGF-40 concentrate into 3/4 of a spray gun jar full of water. Remove Suds-O-Gun nozzle. Adjust the valve opening on the spray gun by means of the adjusting screw located in the rear of the handle so that a fine mist is obtained. Lightly spray floors, rugs or other surfaces upon which dust or air borne bacteria might settle. KGF-40 may also be effectively applied to your Kirby Filter Bag, furnace or air conditioning filters. KGF-40 concentrate is available in a 12 ounce unbreakable plastic bottle from your Kirby Dealer, and will make nearly 2 gallons of effective spray. Rinse the gun and jar with clean water after use. Will not harm any surface not harmed by water alone.

● KIRBY GENERAL COVERAGE WARRANTY

Keep this book at all times

This Kirby General Coverage Warranty, which includes the Kirby Warranty, General Service Insurance, and Coverage of Loss by Fire, is null and void if the name plate or serial number of the Kirby described herein has been defaced, removed, or changed. The remedies provided herein are exclusive. There are no warranties by the Company which extend beyond the statements and description on the face hereof, and this General Coverage Warranty is expressed in lieu of all other warranties, express or implied, of merchantability or otherwise, and of all other obligations or liabilities, on its part, and it neither assumes nor authorizes any other person to assume for it liability in connection with the sale of its products.

WARRANTY

Subject to the conditions and exceptions stated in this Kirby General Coverage Warranty, The Kirby Co., Division of The Scott & Fetzer Company, herein called the "Company," warrants the Kirby product described herein to be free from defects in material and workmanship under normal use and service. At any time within one year from the date of delivery to the original purchaser, the Company will furnish for the Kirby product, a replacement part for any part returned to and found by the Company to be defective. Such replacement part will be furnished without cost to the owner (except transportation charges) through an authorized Kirby Service center or f.o.b. its factory at the Company's election. This Warranty does not apply to belts or to light bulbs, or to damage caused by accident, misuse, negligence, abuse, or to any Kirby products which have been repaired by other than a Kirby authorized service center so as in the judgment of the Company to affect its stability or reliability, or in which parts not made by, sold by, or approved by The Scott & Fetzer Company shall have been used.

GENERAL SERVICE INSURANCE

Subject to the conditions and exceptions stated in this Kirby General Coverage Warranty, and on further condition that the Kirby described herein, has been originally purchased from an authorized Kirby Distributor, Area Distributor, or Dealer, the Company hereby agrees with the original purchaser to entirely rebuild and re-condition such Kirby, when returned to The Kirby Co., Division of The Scott & Fetzer Company, Cleveland, Ohio, any time after the expiration of the WARRANTY and as often as may be required, providing it is still the property of, and in the possession of, the original purchaser as set forth in the following:

1. The Company, in rebuilding and re-conditioning the machine for the original purchaser, will make every effort to keep the cost to such purchaser for this service as low as possible, and the Company will in no case charge such purchaser more than \$32.50 for any one rebuild.
2. The Company's maximum price of \$32.50 shall include all labor and cost of parts necessary to put all Kirby equipment included in the original purchase in A-1 condition.

Transportation charges and replacement costs of broken parts, or missing parts, are, of course, extra charges.

COVERAGE OF LOSS BY FIRE

Subject to the conditions and exceptions stated in this Kirby General Coverage Warranty, and further subject to the condition that the Kirby described herein has been originally purchased from an authorized Kirby Distributor, Area Distributor, or Dealer, the Company agrees:

1. In the event that this Kirby, while owned by and in the possession of the original purchaser, should be damaged by fire, on the premises of such purchaser, the Company will repair or rebuild the Kirby for the such purchaser and return it in A-1 condition, providing that such purchaser will send \$32.50 and the fire damaged remains, prepaid, to the Company's factory in Cleveland, Ohio, within ninety (90) days after damaging fire. If cleaning tools also need replacing by reason of fire damage, an additional charge of \$8.00 will be made. Return transportation to such purchaser's home will be paid by such purchaser.

If the Kirby Power Polisher, Handi Butler, or Flexible Shaft, are damaged or destroyed by fire, the Company will replace the Kirby Power Polisher at a cost of \$7.00 to the customer; the Kirby Handi Butler at a cost of \$13.00; the Kirby Roll-O Waxer at a cost of \$10.00; the Kirby Rug Renovator at a cost of \$13.00; all f.o.b. Cleveland, Ohio.

This service is based upon the conditions that such purchaser has met with all the requirements of the original purchase agreement, and it is distinctly understood that said replacement will in no way nullify or modify the terms of that purchase agreement. If the fire damaged Kirby has not been fully paid for under an installment purchase plan, a statement from the distributor certifying that installment payments are current will be required.

2. In the event that the Kirby, Kirby Attachments, Power Polisher, Handi Butler, Roll-O Waxer, or Rug Renovator, while in the possession of the original purchaser shall be completely and wholly destroyed by fire so that no damaged parts can be returned, an affidavit, sworn to by the original purchaser before a notary public, will be accepted within ninety (90) days after the date of the damaging fire in lieu of damaged parts, and the Kirby and/or attachments will be completely replaced under the terms set forth in Section 1 above.

THE KIRBY COMPANY
DIVISION OF THE SCOTT & FETZER COMPANY
CLEVELAND, OHIO

Manufacturers of the
Kirby Dual Sanitronic "80"
WILLIAM A. REASONER, President

Service calls, including the one-year warranty period, will be at the expense of the owner.

PLEASE COMPLETE THE FOLLOWING

The above Warranty covers Kirby Dual Sanitronic "80"

Serial No. _____

Date of Delivery _____

Authorized Dealer Signature _____

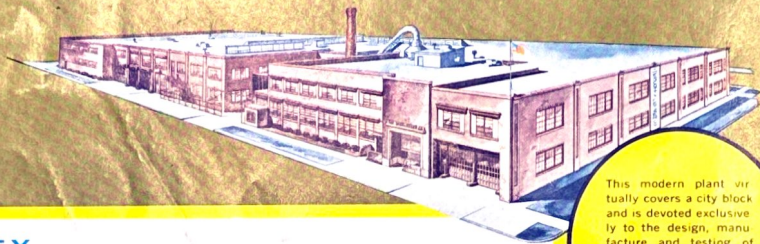

This modern plant virtually covers a city block and is devoted exclusively to the design, manufacture and testing of Kirby Sanitronic systems. More than half a century of experience is your assurance of dependability.

INDEX

Attachments	5, 6, 7, 20, 22	Hand Portable	3, 22	Rug Nozzle Adjustment	9
Attachment Lock	6, 16	Handi-Butler	2, 12, 13, 14, 15	Rug Renovator	3, 19
Bag	11, 17, 20, 30	Handi-Sharpener	15	Speed Selector	5
Bag Guard	30	Handi-Wax	31	Sanding Disks	14, 15
Belt Lifter	8, 12, 13	KGF-40 Concentrate	31	Sani Em-Tor	5, 11, 17
Belt Replacement	29	Handle Lock	10	Sani-Pocket	5, 11
Blower Coupler	20	Handle, Long	16	Service	26, 27
Brush Adjustment	28	Handle, Pin	16	Shampoo	31
Brush Cleaning	28	Handle, Portable	20	Shoulder Portable	4, 22
Brush Roll	28, 29	Hose	20	Shoulder Strap	20
Buffing Wheels	15	Hose Locking Nut	20	Spray Gun	2, 21
Bulb Replacement	30	Long Handle	16	Suction Coupler	20
Cord	17, 30	Lubrication	30	Suction Relief Vent	6, 17
Crystalator	2, 24, 25	Maintenance	26	Suds-O-Gun	2, 21
De-Mothing Unit	2, 24, 25	Mattress Cleaner	3, 22	Surface Nozzle	22
Dirt Trap	5, 11, 17	Motor Switch	10	Switch, Safety	5
Electric Floor Duster	4, 18	Motor Unit	6, 7	Switch, Motor	6, 10
Emptying the Bag	11	Parts	6, 7, 14, 15	Swivel Nozzle	23
Extension Tubes	23	Polishing Compounds	15	Swiveled Cord Hook	5, 30
Flexible Hose	20	Portable Handle	20	Tank-Type Unit	3, 4, 23
Flexible Shaft	14, 15	Portable Units	22, 23	Tilt Latch	10
Floodlight Replacement	30	Power Polisher	3, 18, 29	Toe Touch Nozzle Adjustment	9
Floor Duster	4, 18	Power Tool	2, 14, 15	Tool Cabinet	4
Floor Polisher	3, 18	Roll-O-Waxer	26	Upright Cleaner	3, 16, 17
Floor Portable	3, 23	Rug Cleaner	3, 16, 17	Wands	23
Grinding Wheel	14, 15	Rug Guard	28	Wheel Cups	15
Guarantee	32, 33	Rug Nozzle Attachment	16, 17	Wire Brush Wheel	15

THE KIRBY COMPANY

1920 W. 114 STREET
CLEVELAND, OHIO
44102

DIVISION OF

