

Warranty and Instruction Book

Including general
service insurance,
coverage of loss
by fire and
limited warranty.

Quality, reliability, performance



This book...

is dedicated to you, the owners of the new standard of quality, reliability and performance in home sanitation equipment. It is designed to promote your complete enjoyment of the Kirby® Classic® III System.

Keep this book where it will be handy for quick reference. Read and review it thoroughly, and often. By knowing your Kirby completely, you will more fully realize full value from your purchase and appreciate the Kirby as a truly marvelous and dependable household appliance.

Attachments	3-4-5-14-15-16
Attachment Lock	4-7-14
Bag	4-8-10-11
Bag Guard	29
Belt Lifter	4-6-7
Belt Replacement	27-28-29
Brush Adjustment	15-27
Brush Cleaning	27
Brush Roll	4-27
Buffing Wheels	24-25
Bulb Replacement	29
Canister Type Unit	14-15
Cord	4-9
Coverage of loss by fire	30
Crevice Tool	4-16
Crystalator®	4-17-18
Deflator	18
De-Mothing Unit	17-18
Dirt Trap	4-8-9-11
Duster Buffer®	4-20
Electric Floor Duster Buffer	4-20
Emptying the Bag	11
Extension Tubes	4-14-15
Flexible Hose	4-14-15
Flexible Shaft	3-4-24-25
Floor Duster Buffer	4-20
Floor Polisher	4-22
Floor Portable	15
General Service Insurance	30

Hand Portable	13
Handi-Butler®	3-4-24-25
Handi-Waxer®	3-4-23
Handi-Waxer Wax	23-32
Handle, Long	4-8-9
Handle, Pin	4-8-17
Handle, Portable	4-13-18-20
Handle Stop Latch	4-10
Headlight Replacement	29
Hose	14-15
Instant Suds	19-21-32
Inflator	16
Jig Saw	4-24-25
Limited Warranty	31
Long Handle	4-8-9
Lubrication	29
Maintenance	27-28-29
Massage Cup	4-16
Mattress Cleaner	13
Miracle Head	3-4-22
Motor Switch®	4-10
Motor Unit	4
Odorific®	32
Parts	4-5
Polishing Compounds	25
Portable Handle	4-13-18-20
Portable Units	13-20
Power Plant	4
Power Tool	24-25

Rug Fluffer	3-4-12-22
Rug Guard	27
Rug Nozzle Adjustment	10
Rug Nozzle Attachment	6-7-8
Rug Renovator®	3-4-21
Saber Saw	3-4-24
Safeguards	1-2
Sanding Discs	24-25
Sani Em-Tor®	4-8-9-11
Sani-Pocket®	11
Scuttle®	32
Service	26-27-28-29
Shag King®	3-4-12
Shoulder Portable	20
Shoulder Strap	4-20
Speed Selector	7
Spray Gun	3-4-19
Suction Relief Vent	4-11
Suds-O-Gun®	3-19
Surface Nozzle	3-4-14
Switch, Motor	10
Swivel Nozzle	4-5
Swiveled Cord Hook	9
Toe Touch Nozzle Adjustment	4-10-11
Tool Cabinet	3-15
Upright Cleaner	3-8-9-10-11
Vis-A-Belt®	6
Wands	15
Wax	23-32
Wheel Cups	24-25

Important safeguards in use and care

The Kirby Classic III Model 2CB is listed and approved by Underwriters Laboratories Inc. and Canadian Standards Association as a Double Insulated product for use on 120 volts 50-60 Hz.

The following includes information compiled by the Vacuum Cleaner Manufacturers Association from governmental and private sources concerned with product safety. These basic guidelines, supplemented by additional guidelines pertaining to the operation of particular units throughout the book, are for your protection and convenience. Please read them carefully.

To Avoid Accidents

- Never vacuum up live ashes or cigar or cigarette butts.
- Never run cleaner over power cord, or place sharp objects on cord.
- Never let children use cleaner or equipment as a toy.
- Use extra caution when cleaning on stairs.
- Keep cleaner on floor — not chairs, tables, etc.
- **WHEN CLEANER IS TURNED ON, NEVER ALLOW FINGERS, HAIR OR GARMENTS TO COME NEAR INTAKE SUCTION PORTS, NOZZLE, REVOLVING BRUSHES, OR EXPOSED FAN HOUSING.**
- Never leave cleaner running or cord plugged in when unattended.

WARNING

Electric shock could occur if used outdoors or on wet surfaces

To Avoid Electric Shock

- Never vacuum liquids.
- Never vacuum floors, rugs or carpeting that are wet.
- Do not store outdoors.
- Replace worn or frayed power cord, immediately.

- When disconnecting cleaner, grasp plug — not cord.
- Always unplug power cord from wall socket before servicing machine or attaching accessories.
- Store cleaner, attachments and accessory units promptly after each use to prevent accidents caused by tripping over power cord or equipment.
- Use Kirby, attachments and accessory units only in manner intended and outlined in this book.
- Be sure motor and fan have stopped before changing units.
- Don't use your vacuum as a sprayer of flammable liquids, such as oil-base paints.

To Avoid Accidents (cont.)

- Don't use in an enclosed space where flammable, explosive or toxic materials are stored, such as oil-based paint, thinner, gasoline, etc., or where vapors from such materials are given off.
- Don't use cleaner to pick up hard or sharp items, such as coins, pins, nails, etc.
- Don't close door on cord, or snag it under furniture or doors with sharp edges.
- Don't use cleaner, attachments or accessory unit if in poor condition. Have qualified service person inspect, replace or repair whenever necessary.
- Don't use cord to pull cleaner around.
- Don't operate cleaner out of an incandescent light fixture.
- Don't move tables, lamps, etc. while holding onto equipment.

For best performance

- Keep your Kirby, attachments and accessory units clean and in good operating condition.
- Empty filter bag and Sani Em-Tor after each use.
- Check revolving brushes for build-up of lint, hair or other foreign material and remove as necessary.
- Adjust or replace cleaning and polishing brushes when worn.
- Replace broken or worn out rubber belt.
- Have your equipment serviced only by an authorized Kirby Distributor or Area Distributor with identical parts, or parts approved by The Kirby Company Division. Only authorized Kirby Distributors and Area Distributors may properly use and display the Kirby registered trademarks.
- Have your equipment checked periodically by an authorized Kirby Distributor or Area Distributor service center.
- Store Kirby, attachments and accessory units, carefully — in dry area — never outdoors.
- For optimum cleaning performance and safety, study and follow this use and care book

Notice:

The information and specifications included in this use and care book were in effect at the time of approval for printing. The Kirby Company reserves the exclusive right, however, to discontinue or change specifications or designs at any time without notice and without incurring any liability whatsoever.

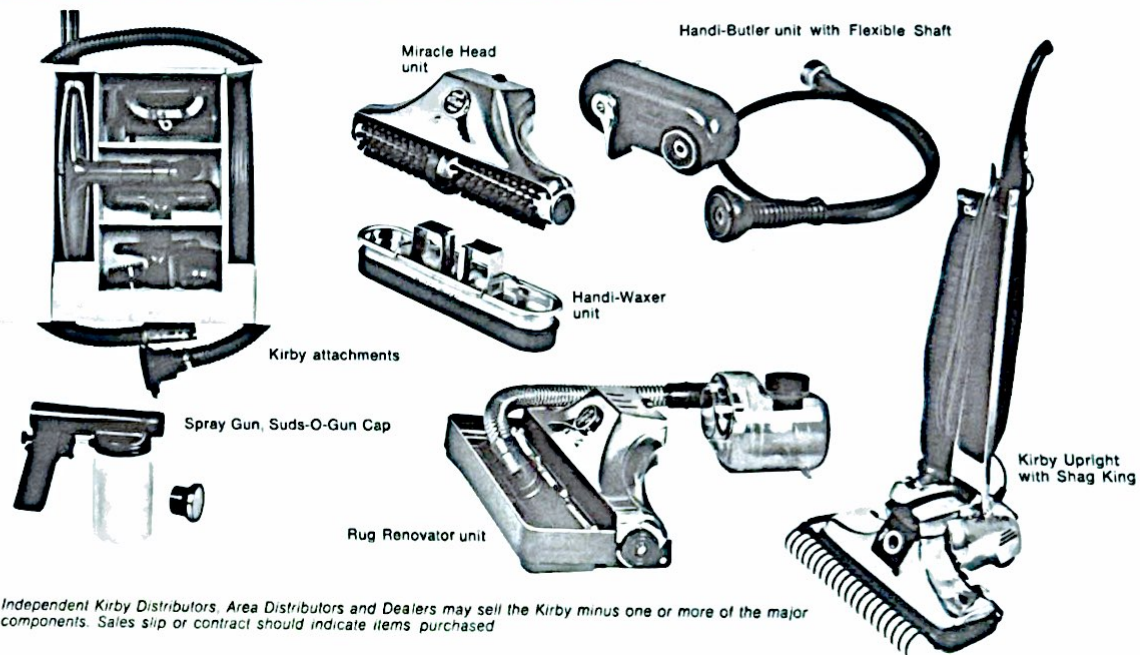

Independent Kirby Distributors, Area Distributors and Dealers may sell the Kirby minus one or more of the major components. Sales slip or contract should indicate items purchased.

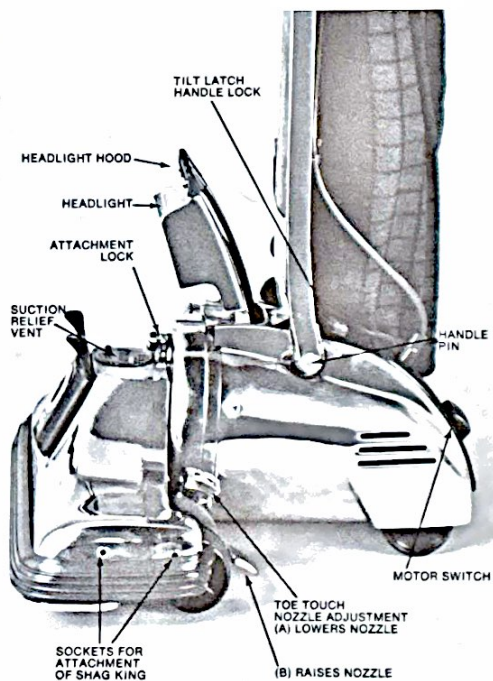

**Know your Kirby & its parts
to realize maximum value
and satisfaction from it.**

1. FILTER BAG
2. FILTER BAG GUARD
3. SANI EM-TOR
4. DUSTER-BUFFER
5. LONG HANDLE
6. BELT
7. BRUSH ROLL
8. BELT LIFTER
9. SUCTION RELIEF VENT
10. RUG NOZZLE
11. PORTABLE HANDLE
12. JIG-SABER SAW
13. HANDI-BUTLER
14. SHOULDER STRAP
15. HANDLE PIN
16. MIRACLE HEAD
17. CORD
18. FLEXIBLE SHAFT
19. POWER PLANT
20. CREVICE TOOL BRUSH

21. DUSTER BRUSH
22. MESSAGE CUP
23. UTILITY BRUSH NOZZLE
24. UTILITY AIR NOZZLE
25. CRYSTALATOR
26. SURFACE NOZZLE — SWIVEL ATTACHMENT
27. CREVICE TOOL
28. STRAIGHT EXTENSION TUBE
29. CURVED EXTENSION TUBE
30. SPRAY GUN
31. HOSE COUPLER
32. FLEXIBLE HOSE
33. SWIVELED COUPLER TUBE
34. RUG RENOVATOR
35. HANDI-WAXER
36. SHAG KING
37. SUDS-O-GUN CAP
38. INFLATOR/DEFLATOR
39. DRILL CHUCK

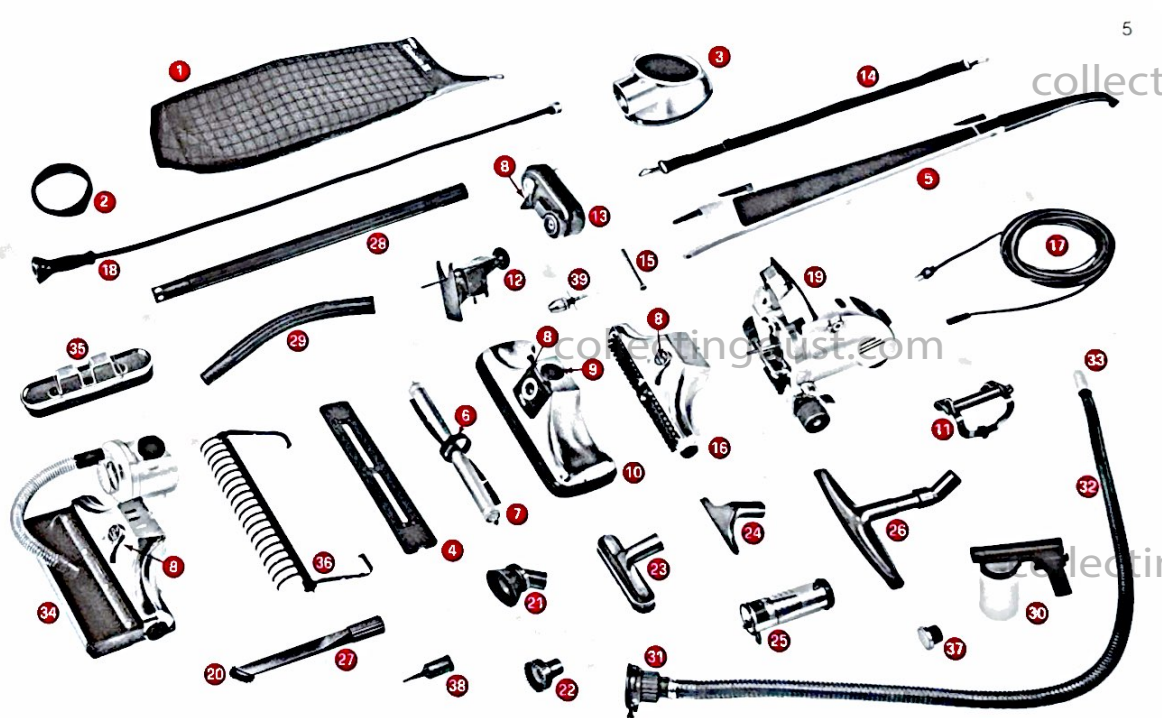

6 The Kirby Rug Nozzle, Rug Renovator, Miracle Head and Handi-Butler are attached to or removed from the power plant by use of the Magic Finger Belt Lifter

WARNING: ALWAYS UNPLUG POWER CORD FROM WALL OUTLET AND BE SURE KIRBY MOTOR AND FAN HAVE STOPPED BEFORE CHANGING UNITS. DO NOT ACTIVATE SAFETY SWITCH BY HAND.

The Kirby belt transfers power from the power plant to the Kirby unit attached to it. The "magic finger" Belt Lifter makes it easy for you to raise or lower the belt in each unit without your having to touch the belt.

Since proper use of the "magic finger" Belt Lifter is important to the effective use of eight Kirby units — the upright cleaner with revolving brush, straight suction upright cleaner, hand portable, floor polisher, rug fluffer, Handi-Butler, Rug Renovator and Duster Buffer unit — be sure you understand how to use the Belt Lifter before proceeding further.

To attach or remove units, the belt must be in the raised or "off" position, so that it does not come in contact with the belt drive shaft (motor pulley) of the power plant.

Figures 1, 2, 3, 4 and 5 show the position of the "magic finger" Belt Lifter when the belt is in the raised or "off" position. Notice in figures 1, 3 and 4 that when the Belt Lifter is in the "off" position, the words on the labels are vertical.

While there is no label on the Belt Lifter of the Handi-Butler, (figure 5) the words "on" and "off" are shown on the Handi-Butler body to indicate the position of the belt.

The finger of the Belt Lifter must be raised and engaged with the belt to attach the Rug Nozzle, Rug Renovator, Miracle Head, or Handi-Butler to the power plant. The position of the finger and belt can be checked by looking into the back of the unit to see if the belt is raised on the magic finger.

The Vis-A-Belt on the Rug Nozzle lets you see the position of the belt at all times.

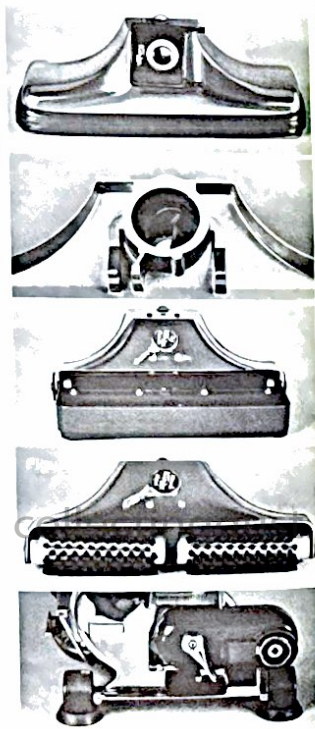

To attach the Rug Nozzle, Rug Renovator, Miracle Head or Handi-Butler to the power plant:

1. Prepare unit to be attached by turning Belt Lifter to the "off" position. Make certain that Belt Lifter finger is raised and has engaged the belt by looking into the back of the unit. (see figure 2.)
2. Set Toe Touch Control to number 8 position. (See photo on page 4, or instructions on page 10.)
3. Raise Headlight Hood.
4. Place attaching slots at back of unit, which you desire to use, over the attaching bar of the power plant. (See Figures 6 and 7.)
5. Swing unit to be attached back towards power plant. (See figure 7). A slight downward pressure may be needed in attaching the Crystalator, so as to depress the Speed Selector Switch Arm.
6. Hold unit to be attached in place with one hand, and use other hand to lock unit in place by turning Attachment Lock Lever located at top front of power plant. (See figure 8.)

7. Turn Belt Lifter to "on" position. When "Belt Lifter" is in the "on" position, words on label of Belt Lifter of the Rug Nozzle, Rug Renovator and Miracle Head are horizontal. (See figure 9.)

By looking through the Vis-A-Belt on the Rug Nozzle you will be able to see that the belt is in contact with the belt drive shaft (motor pulley) of the power plant.

The "on" position of the Belt Lifter is the operating position of the Rug Nozzle, Rug Renovator, Miracle Head and Handi-Butler. The exceptions to this are when the Rug Nozzle is used with the Duster Buffer, or when you want to use the Kirby upright as a straight suction cleaner, in which case the operating position is with the Belt Lifter in the "off" position. In some instances the Hand Portable should also be used with the Belt Lifter in the "off" position.

To remove the Rug Nozzle, Rug Renovator, Miracle Head or Handi-Butler from the power plant, simply reverse the above seven steps. Be sure Belt Lifter is in the "off" position before releasing the Attachment Lock Lever.

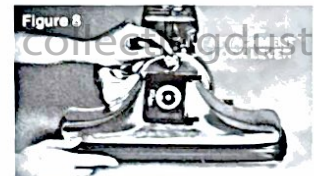

WARNING: ALWAYS UNPLUG POWER CORD FROM WALL OUTLET AND BE SURE KIRBY MOTOR & FAN HAVE STOPPED BEFORE CHANGING UNITS.

To assemble the Kirby as an upright cleaner, the following items should be attached to the power plant: Rug Nozzle, Long Handle, Cord, Sani Em-Tor and Filter Bag.

Attachment of Rug Nozzle

Instructions for attachment of the Rug Nozzle to the power plant are given on the preceding pages, 6 and 7.

Attachment of Long Handle

1. The long handle consists of two pieces, and is usually assembled by the Kirby Dealer at the time of purchase. When necessary to assemble the long handle, proceed as follows:
 - a. Grasp handle grip in one hand, and use other hand to hold metal handle part, near small end.
 - b. Push the handle grip part into the narrow end of the metal handle part until you hear a snap.
 - c. To lock handle in place, grasp cord hook, and while pulling cord hook away from handle (against the spring) turn it as a wrench, clockwise, about three complete turns. If you wish, you may use a Phillips screwdriver in the "cross" slot provided in the attaching screw head.

Note: Should you ever want to disassemble the handle to re-pack the Kirby proceed as follows:

- a. Grasp cord hook and while pulling cord hook away from handle (against the spring) turn it counter clockwise, about three complete turns.
- b. Press down on the screw head with one hand, and pull out the handle grip with the other hand

2. Remove Handle Pin from power plant by pulling straight-out with a slight twisting action.
3. Insert the fork of the assembled long handle into the slide at top of power plant. (See figure 1)
4. Replace Handle Pin as far as it will go into both holes of the Handle Fork.

Attachment of Sani Em-Tor & Filter Bag

1. The Filter Bag is usually attached to the Sani Em-Tor by the Kirby Dealer at the time of purchase. When necessary to attach Filter Bag to the Sani Em-Tor, proceed as follows:
 - a. Place Filter Bag Guard over open end of Filter Bag
 - b. Place part of open end of the Filter Bag below lip of Sani-Em-Tor, and using both hands to grasp the other part of open end of the Filter Bag, pull bottom part of the Filter Bag over lip of the Sani Em-Tor.

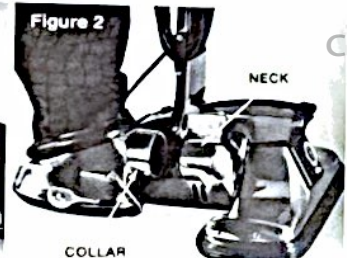
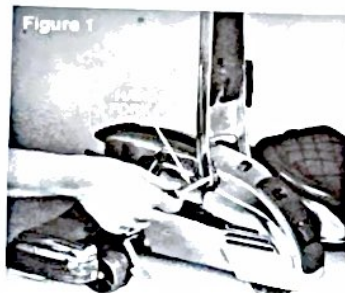

the Upright Cleaner with Triple Cushion Vibration

- c. Move Filter Bag around Sani Em-Tor lip to make front of Filter Bag parallel with front of Sani Em-Tor collar. The seam of the filter bag should be in line with the center of the rear of the Sani Em-Tor.
- d. Slide Filter Bag Guard down Filter Bag and stretch over bottom part of Filter Bag and lip of Sani Em-Tor.

2. On the inside of the Sani Em-Tor Collar you will notice three curved slots. These should be lined up with the pins on the neck of the power plant. (See figure 2.)
3. Slide the collar firmly over the neck of the power plant, and twist downward. The Sani Em-Tor will lock firmly in place.

When the Sani Em-Tor is new, the gasket inside the collar of the Sani Em-Tor will be stiff and offer some resistance. This gasket is necessary to provide an airtight seal.

Note: To remove the Sani Em-Tor from the power plant, simply twist from the bottom and away from the power plant. It will unlock from the power plant with a snap

4. The top of the Filter Bag is attached to

the Handle Grip by fastening the wire loop on the top of the Filter Bag to the upper hook of the hanging clip on back of Handle Grip portion of Long Handle. When this is done after attachment of the cord, the attachment of the cord is easier.

Attachment of Cord

1. Plug the cord into rear of the power plant just above the Switch Button.
2. Fasten the grommet on the cord into the lower hook of the hanging clip, just below the bag hook and wind cord down and under the lower cord hook, and up over the top cord hook.
3. To keep the cord out of the way when the handle is lowered to the horizontal position, twist cord under the two projecting hooks near the bottom of rear handle cover in such a way as to allow the cord to slide freely once it is under the hooks.

When not using the assembled upright cleaner, wrap cord around cord hooks on long handle. (See figure 4.) The top cord hook swivels to permit fast release of the wound-up power cord for use. (See figure 3.)



Figure 4

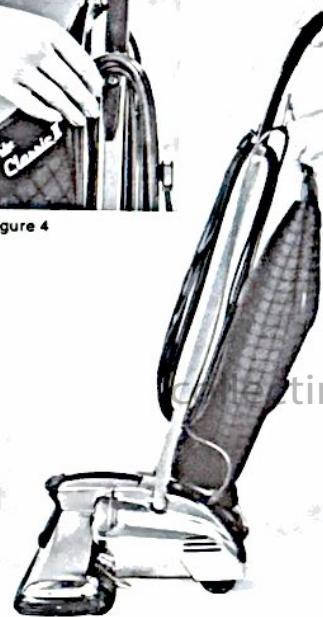

Motor Switch

The Kirby motor is turned on or off by depressing the large push button switch located just above the rear wheels with either your hand or toe of your shoe. Most Kirby owners find the easiest way to operate the motor switch is to simply raise the toe of one shoe and pull the Kirby back until it touches the motor switch button. A slight downward and backward movement of the toe of the shoe will then activate the motor switch.

Handle Stop Latch

By sliding the Handle Stop Latch Button towards the Toe Touch Control side of the Kirby, a Handle Stop is extended making it possible, with a downward pressure on the long handle, to raise the rug nozzle up and over the edge of rugs, large pieces of litter, door sills, and obstructions.

By sliding the Handle Stop Latch Button to the extreme opposite position—towards the filter bag and Sani Em-Tor, the stop is retracted and long handle can be lowered to horizontal position for cleaning under furniture.

To lock the handle in this horizontal flat position for storage of your Kirby on end-in-small closets, etc. simply push the Handle Stop Latch towards the Toe Touch Control side of your

Kirby, while the long handle is still held in the horizontal position.

Toe Touch Control

To adjust your Kirby Rug Nozzle properly for use on your rugs and carpeting, simply depress the large lever (see figure 1-B) with toe of your shoe as far as it will go. This raises the Rug Nozzle to the maximum height, and the pointer will indicate number 8 when viewed through the opening in the adjustment scale. (See figure 1-A.)

Turn Power Plant on and depress adjustment scale (A) with toe of your shoe. Each time you depress the adjustment scale, the Rug Nozzle will lower one notch. Continue to depress adjustment scale one notch at a time until you notice a change in the sound of your Kirby Power Plant. This indicates that the Rug Nozzle is at the correct level for the thorough cleaning of your rugs and carpeting.

If the suction between the Rug Nozzle and the surface to be cleaned is broken with normal movement of your Kirby, lower the Rug Nozzle one more notch.

This same adjustment of the Toe Touch Control can be used when operating the Hand Portable, straight suction upright cleaner, Duster Buffer unit, Miracle Head or Rug Renovator



The Toe Touch Control also enables you to raise the front of your Kirby for ease in changing units.

Sani Em-Tor & Sani Pocket

For maximum cleaning efficiency, the Filter Bag and Sani Em-Tor should be emptied after each use of your Kirby. If dirt is allowed to accumulate, the cleaning efficiency of any vacuum cleaner will be reduced.

To empty the Filter Bag in your home without fuss, muss or expense:

1. Spread newspapers on the floor and place Kirby on it.
2. Raise headlight hood and make certain Suction Relief Vent is in closed position.
3. Detach wire loop on top end of Filter Bag from hook on long handle grip.
4. Lower Rug Nozzle to number 1 position on Adjustment Scale, and turn on motor.
5. Allow motor to run briefly and then turn off. While Filter Bag is still inflated, shake it vigorously from the top.
6. Tilt Kirby slightly and turn lever on side of Sani Em-Tor to release bottom cover of Sani Em-Tor. In "open" position, the Sani Em-Tor lever will point to the rear of the Kirby.
7. Swing bottom cover of Sani Em-Tor out from under Sani Em-Tor and turn it upside down, (See Figure 3) emptying the dirt and lint onto the newspaper. The cover will stay in this position while the Filter Bag is being emptied.
8. After all dirt has been removed from Sani Em-Tor and Filter Bag, swing Sani Em-Tor cover back into place, and lock securely with Sani Em-Tor lever. Make sure Sani Em-Tor lever is fully rotated to "closed" position.

If excessive dirt and lint has accumulated in the Filter Bag and does not fall readily into the Sani Em-Tor, use the following procedure.

1. Open zipper at rear of Filter Bag and place hand into Sani-Pocket, (See Figure 2) grasping Sani-Scraper at bottom of pocket.
2. Scrape sides of Filter Bag with Sani-Scraper with downward strokes.
3. Using Sani-Scraper, push excess lint and dirt into Sani Em-Tor.
4. Empty as in 6 through 8 above.

Suction Relief Vent

The Suction Relief Vent enables you to reduce the suction of the Kirby, when desirable, for cleaning deep pile cotton or synthetic rugs and carpeting, or lightweight throw rugs. Turn the Suction Relief Vent clockwise to open vent and reduce suction of your Kirby. When Suction Relief Vent is in the "open" position, the Headlight Cap should always be all the way down against the Rug Nozzle.

Suction Relief Vent should be in "closed" position for normal full power cleaning operations, and when emptying the Filter Bag.

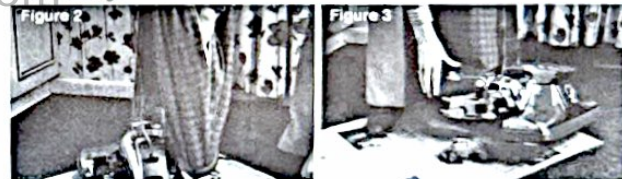



WARNING: ALWAYS UNPLUG POWER CORD FROM WALL OUTLET AND BE SURE KIRBY MOTOR & FAN HAVE STOPPED BEFORE CHANGING UNITS.

Attachment and Removal

Attaching the Shag King is easily accomplished when both the hinges, located at the frame arm ends, are swung upward. Then using the hinges as thumb tabs, place the projections on the arms into the two blind holes on each side of the Kirby Classic III Rug Nozzle. The center support bar on the frame should be resting on the bumper in front of the nozzle. Then swing the hinges down over the wings at the back of the nozzle to lock it on.

For removing the Shag King, reverse the above procedure.

Attachment and removal of the Shag King is made easier when the Kirby Classic III Toe Touch Control and the Shag King are in the highest position.

Using the Shag King

The Kirby Shag King can be adjusted to four positions which, in conjunction with the eight positions provided by the toe touch control of the Kirby Classic III, will provide the correct cleaning and combing height for any shag rug or carpet.

Adjustment of the Shag King is made by gripping the knob on the left side of the Shag King as you look at it from the front, and after pressing in, rotate the knob until the slot that you have selected in the rake cam is lined up with the tab on the Shag King frame. Release the knob, and your Shag King is now locked into your selected position.

The more you rotate the cam toward the cleaner the higher the rake lifts out of the carpet pile. Rotating all the way toward the cleaner to the stop is used when cleaning standard carpeting or attaching and removing the Shag King. The more you rotate the cam toward you the deeper the raking and combing action

WARNING: ALWAYS UNPLUG POWER CORD FROM WALL OUTLET AND BE SURE KIRBY MOTOR & FAN HAVE STOPPED BEFORE CHANGING UNITS.

The Hand Portable is a powerful unit designed for the deep down cleaning of thick cushions, mattresses and carpeted stair treads.

To assemble the Hand Portable attach the Rug Nozzle, Sani Em-Tor and Filter Bag, cord and Portable Handle (included in the Attachment Case) to the power plant. Hook the top loop of the Filter Bag to the hook at the rear of the Portable Handle. The assembly of the Hand Portable is similar to assembly of the upright cleaner, except the Portable Handle is used in place of the Long Handle.

When using the Hand Portable on thick cushions or mattresses, turn Belt Lifter to the "off" position in order to prevent any chance of pulling up a button or tuft.

WARNING: WHEN USING HAND PORTABLE, KEEP UNIT MOVING ACROSS SURFACE TO BE CLEANED. DO NOT LET IT REMAIN RUNNING IN PLACE OVER ONE AREA.

Use Toe Touch Control to set the nozzle height at the proper height for cleaning.



Figure 1

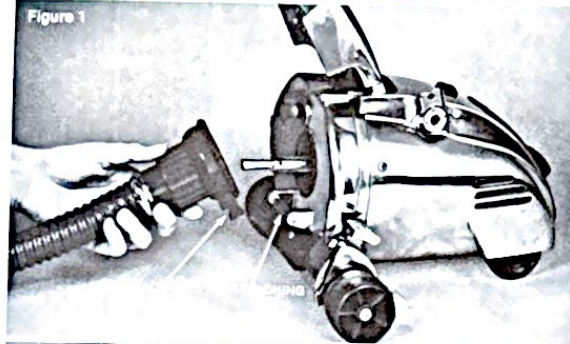

WARNING: ALWAYS UNPLUG POWER CORD FROM WALL OUTLET AND BE SURE KIRBY MOTOR & FAN HAVE STOPPED BEFORE CHANGING UNITS.

The Tank-Canister cleaner is designed for above-the-floor cleaning operations. Various combinations of the extension tubes and tools make it a versatile and easy-to-use cleaner.

To assemble, attach the Sani Em-Tor and Filter Bag, Portable Handle, Cord and Flexible Hose to the power plant. The Kirby flexible hose is designed for direct connection to either the "suction" (front) or "blower" (bag connection) side of the power plant, by means of the universal coupler attached to the hose.

To attach flexible hose to suction intake, set adjustment scale of Toe Touch Control to position number 8. Hook the attaching slots of the Hose Coupler over the attaching bar at front of power plant. Press down and swing the Hose Coupler against the power plant, and lock in place with the Attachment Lock Lever. (See figures 1 and 2.)

Extension tubes and tools are connected simply by inserting tapered end of the flexible hose or extension tube into one another, or the desired tool, with a firm twist. To separate, simply twist and pull.

Small holes in the Extension Tubes, Hose End and the Angle Piece that attaches to the Surface Nozzle are Kirby

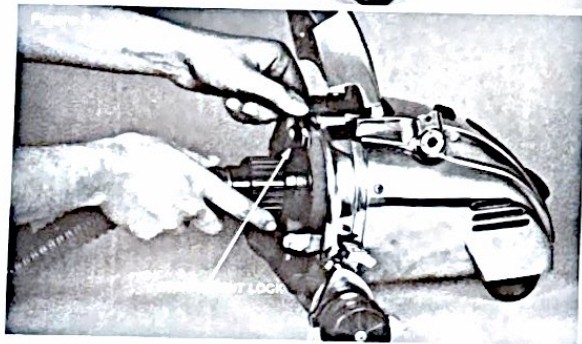

safety features designed to alleviate chances of injury or damage from excessive suction being inadvertently applied to a sensitive area.

Figure 4 shows how the Flexible Hose, Extension Tubes and Surface Nozzle are assembled when the tank-canister cleaner is used for the surface cleaning of rugs, carpeting and hard surfaced floors under your low furniture.

There is an easily identified place for each basic Kirby Attachment in the Attachment Case, (See Figure 3) which has been designed for your convenience in use and storage. The attachment case can be hung on a doorknob or closet hook for handy use of tools.

The Surface Nozzle has a Brush Adjustment Lever on the front which raises or lowers the Surface Nozzle Brush. The "up" position is recommended for the surface cleaning of resilient floors (dust only), deep pile, braided and cotton pile rugs. The "down" position is recommended for surface cleaning of carpeted areas (lint, fuzz), under low furniture or behind furniture.

To prevent possible scratching of hard surfaced floors, such as finished wood floors, the Surface Nozzle should be used with the Duster Buffer. Simply center Duster Buffer over bottom of Surface Nozzle, and snap spring clips of Duster Buffer into bottom of Surface Nozzle.



Figure 3

Figure 4

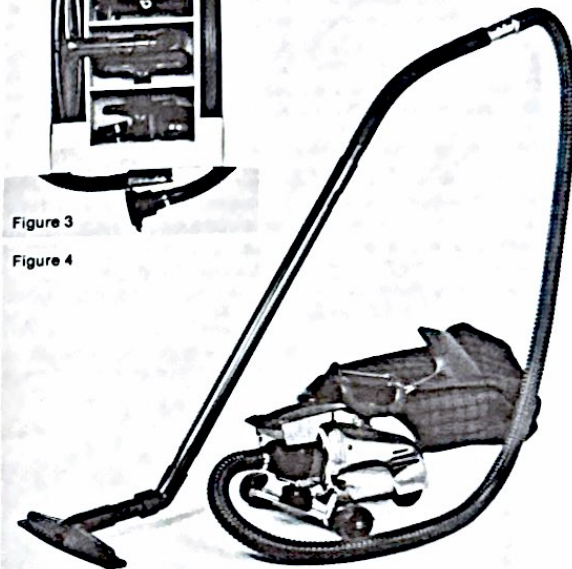

In addition to the Duster Buffer and Surface Nozzle, (described earlier) the following cleaning tools are included in the Attachment Case:

1. Utility Brush Nozzle — for cleaning walls, ceilings, window moldings, cornices, furnace and air conditioning ducts, door-jamb, and lintels, lighting fixtures, the top of high shelves, bookcases, etc. It is generally used on the end of the Extension Tube.

2. Utility Air Nozzle — This tool is most frequently used, attached to the end of the Flexible Hose, for the surface cleaning of upholstered furniture. Used on the end of the Extension Tube, it is ideal for surface cleaning of draperies.

3. Duster Brush — this soft-bristled brush is usually attached to the end of the hose and used for dusting venetian blinds, lamp shades, books, bookcases, moldings, picture frames, furniture, etc.

4. Crevice Tool — Attached to the end of Flexible Hose or Extension Tubes, this tool with the Crevice Tool Brush in place is used for cleaning radiators, registers and other hard-to-dust places. Without the Crevice Tool Brush it is used to clean the crevices in

upholstered furniture, and to direct the flow of moth crystals. (Blowing).

5. Massage Cup — Attached to the end of the Flexible Hose, the Massage Cup is used to give a tingling, cleansing, energizing scalp or body massage or it may be used for cleaning pets.

6. Inflator/Deflator — Attached to the end of hose with Kirby set up as for use with the Spray Gun or Suds-O-Gun, you can quickly and easily inflate beach balls, swimming pool floats, vinyl air mattresses, and a variety of inflatable items. With the Flexible Hose on the front of the power plant, you can quickly deflate these items for repacking or storage without the bother of pressing out air bubbles.

7. Swiveled Coupler Tube — Designed for use with the Surface Nozzle, the swiveled coupler tube permits the user to lower the extension tubes when cleaning under low furniture. The end with the small holes is inserted into the Surface Nozzle, and the other end is attached to the straight extension tube. (See Page 15).

Note: All brushes in the Kirby Cleaning Tools are removable for greater versatility, and economical replacement.

Figure 1

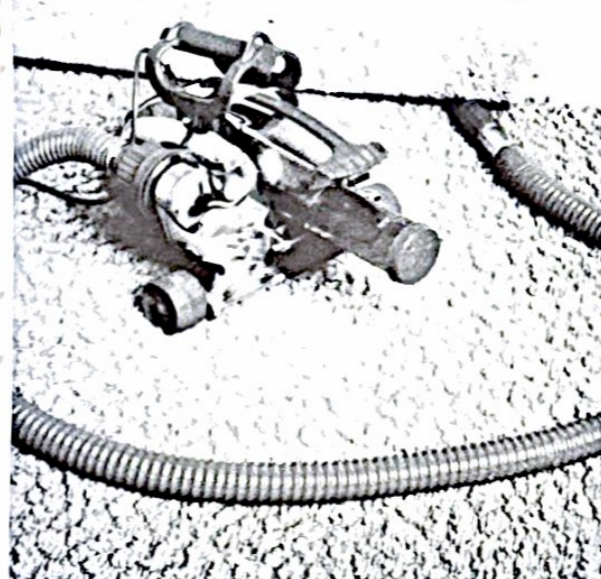

WARNING:

FOLLOW DIRECTIONS AND CAUTIONS ON LABEL OF CRYSTAL CONTAINER. KEEP CRYSTALS OUT OF REACH OF CHILDREN. CRYSTALS MAY BE HARMFUL IF TAKEN INTERNALLY. DO NOT BREATHE THE CONCENTRATED GAS FROM THE CRYSTALATOR. DO NOT ENTER A TREATED CLOSET UNTIL IT HAS BEEN VENTILATED. DO NOT REMAIN IN A TREATED ROOM UNTIL GAS CONCENTRATION IS REDUCED TO SAFE LEVEL. IF EYE, THROAT, OR SKIN IRRITATION OCCURS, DO NOT REMAIN IN TREATED AREA. RETURN UNUSED CRYSTALS TO CLOSED CONTAINER AND SEAL TIGHT. IN THE CRYSTALATOR, USE ONLY 100% PURE PARADICHLOROBENZENE WITH U.S.D.A. REGISTRATION NUMBER ON THE CONTAINER.

Prior to assembly of the Crystalator unit, fill Crystalator with Paradichlorobenzene Crystals (moth crystals) by pulling cap off the Crystalator body and pouring in crystals until Crystalator is about half full when held in horizontal position. A finger inserted in the inner cone of the Crystalator will close the slot and prevent spillage. Replace cap and turn to desired setting: "Gas" for demothing a closet or other confined area; "Medium Crystals" for furniture, baseboards, carpets, etc.; "Full Crystals" when it is desirable to deposit large crystals in chests or storage boxes.

Note: When using moth crystals the Air Vent Slide Cover on top of the barrel of the Crystalator should be in the closed position.

Assembly

Remove Sani Em-Tor with Bag and Long Handle. Place Hose Coupler over the neck or blower (bag connection) end of the power plant and push it into place with a clockwise twist. It will lock into position. Place the attaching slots of the Crystalator over the attaching bar at the front of the power plant. Swing the



Crystalator back against the power plant while pressing slots firmly down on attaching bar, and lock in place with the Attachment Lock Lever. If cleaner does not run, Crystalator was not pressed down enough before locking to power plant.

Attach Portable Handle making certain that Handle Pin goes into both holes of the Handle Fork.

Remove Crevice Tool Brush by squeezing the wire together at the point where it enters the Crevice Tool and pulling straight out. Attach Crevice Tool to end of Flexible Hose.

De-mothing a Closet

WARNING: AS PARADICHLOROBENZENE ATTACKS VINYL, THE CRYSTALATOR SHOULD ONLY BE USED IN THIS MANNER WITH GARMENT BAGS MADE OF POLYETHYLENE. PARADICHLOROBENZENE ALSO ATTACKS STYRENE PLASTIC. PLASTIC COAT HANGERS, HAT BOXES OR SIMILAR PLASTIC ITEMS SHOULD BE REMOVED FROM THE CLOSET BEFORE USING THE CRYSTALATOR.

Place Crystalator with hose and crevice tool (without brush) on floor in front of closed closet door. Position crevice tool so that air flow is directed into closet from under the door. Use a throw rug around crevice tool to seal the remaining opening under door. Turn the Crystalator cap to the "Gas" position, and turn on power plant. Allow the power plant to run 5 to 15 minutes, depending on the size of the closet.

If crystals cling together, they tend to stop the action of the Crystalator. If this happens, just place your hand over the holes in the top of the Crystalator body for a second while the motor is running. This will loosen the crystals and start them flowing into the fan chamber.

The Crystalator with hose and crevice tool (without brush) attached may also be used to de-moth clothes in a garment bag as illustrated in Figure 2.

Figure 2



The Spray Gun

Assemble the Kirby as instructed on page 17 for the Crystalator and in place of the Crevice Tool attach the Spray Gun to end of Flexible Hose with a firm twist.

Do not put crystals in Crystalator, and make certain Air Vent Slide on top of the the barrel of the Crystalator is in the "open" position.

To fill Spray Gun Jar, unscrew from the unit and fill about three-fourths full with liquid to be sprayed. If you will have to tip Spray Gun during use, it may be necessary to fill Spray Gun Jar with a lesser amount to avoid spillage. The telescoping supply tube should project downward to bottom of the Spray Gun Jar. The telescoping supply tube allows you to use larger jars.

The Kirby Spray Gun is designed for household use only. It is recommended for use with water based paints only in accordance with the paint manufacturer's instructions and non-flammable sprayable liquids.

WARNING: DO NOT USE THE SPRAY GUN WITH FLAMMABLE LIQUIDS SUCH AS OIL BASED PAINTS. WHEN A FLAMMABLE LIQUID IS SPRAYED, THERE MAY BE DANGER OF FIRE OR EXPLOSION, ESPECIALLY IN A CLOSED ROOM. UNDER NO CIRCUMSTANCES SHOULD THE COMPRESSOR (POWER PLANT) BE USED IN CONNECTION WITH THE SPRAYING OF FLAMMABLE LIQUIDS.

To use assembled Spray Gun, turn on motor and adjust Spray Gun to desired type of spray. Turning the button at the rear of Spray Gun

clockwise makes the spray finer. Pull trigger with index finger to spray. Avoid tilting Spray Gun as much as possible. Use slow sweeping motions.

The Spray Gun may be quickly and easily cleaned immediately after use with water based paints by spraying water through the gun using a clean jar. If necessary, the entire assembly may be taken apart by removing the valve stem and immersing these parts in water.

The Suds-O-Gun

Assemble Spray Gun unit as explained above, and place Suds-O-Gun Cap over the front of Spray Gun with clockwise twist.

Mix Kirby Instant Suds as directed on bottle and fill Spray Gun Jar about three-fourths full. Adjust Spray Gun to a very fine spray by turning button at rear of the Spray Gun clockwise. Turn on motor and pull trigger with index finger. A volume of suds will then be produced. Suds can be spread directly on surface to be cleaned, or gathered, in a basin, or on several thicknesses of newspaper.

TEST THE FABRIC SURFACE YOU WANT TO CLEAN FOR COLOR BLEEDING AND WATER SPOT RESISTANCE BEFORE USING SUDS. BY FIRST APPLYING THE SUDS SOLUTION TO AN AREA WHICH DOES NOT SHOW. ALLOWING IT TO DRY AND OBSERVING THE RESULTS.

The suds should be worked into the surface with a brush or sponge until they disappear. Allow a few minutes for surface to dry thoroughly and then vacuum with appropriate cleaning tool to remove the dry residue which now contains grime and dirt.



Straight-Suction Upright Cleaner

The straight suction upright cleaner is ideal for use on matted rug pads and certain other types of non-woven rugs or carpeting. Assemble Kirby as an upright cleaner as explained on page 8, except leave "magic finger" Belt Lifter in the "off" position as shown in figure 1. Use the Toe Touch Control to adjust cleaner to proper height.

Duster Buffer

With the Kirby assembled as a straight suction upright cleaner, snap the Duster Buffer Pad into place by inserting the spring clips into the Rug Guard on bottom of the Rug Nozzle.

Lower the Rug Nozzle by using the Toe Touch Control until the Duster Buffer Pad rests firmly against the floor. Turn on motor and you are ready to buff and dust hard surfaced floors as you vacuum. (See figure 2.)

To remove excess dirt from surface of Duster Buffer Pad when you are through cleaning, simply remove the Duster Buffer Pad and run Kirby upright cleaner over its surface. The Duster Buffer may also be used with the Surface Nozzle. (See page 15.)

Shoulder Portable

The Shoulder Portable is ideal for cleaning large areas where considerable mobility and freedom of hands are desired. Assemble Kirby as a canister type cleaner. (See pages 14 and 15.) Then add the Shoulder Strap by hooking one end to loop at front of Portable Handle, and the other end to loop at rear of Portable Handle. Slip unit over shoulder so it rests on back as shown in figure 3.

The Shoulder Portable is also convenient for use with the Handi-Butler and Flexible Shaft. (See pages 24 and 25.)

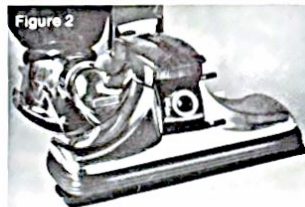

WARNING: ALWAYS UNPLUG POWER CORD FROM WALL OUTLET AND BE SURE KIRBY MOTOR & FAN HAVE STOPPED BEFORE CHANGING UNITS.

Before shampooing rugs or carpeting with the Rug Renovator, the entire area to be renovated must be thoroughly vacuumed using the Kirby Upright Unit.

Attaching Renovator Tray

Remove the Rug Nozzle, Sani Em-Tor, and bag from the Kirby. The Renovator Tray attaches to the nozzle assembly (figure 1) by sliding the Renovator Tray into the slots at each end of the nozzle assembly. Turn the Belt Lifter to "OFF" position and attach the Renovator Nozzle to the front of the Kirby power plant the same way you attached the Rug Nozzle. (See pages 6 and 7.)

Attach the Renovator Tank to the "blower" (bag connection) of the Kirby, as you did the Sani Em-Tor, making sure the sponge-like filter is in place. (See attachment of Sani Em-Tor, page 8.)

Insert angle end of hose with the grommet fitting into the hole in the Renovator Tray (see figure 1). Slip other end of the hose over the Tank Discharge Suds-O-Screen.

Using the tank cap as a measure, put 4 ounces of Kirby Instant Suds (two tank caps full) into the Renovator Tank, then add warm water to the "fill" line (1 quart). One tank full of solution should be sufficient to clean an area approximately 9 x 12 ft. If you plan to clean an area larger than this and need to refill the tank, it is recommended you first rinse any accumulated lint off the tray, hinged shelf and brush area.

Adjusting Renovator

To adjust the Rug Renovator to the proper height for shampooing your rug or carpeting, depress the Toe Touch Control lever as far as it will go. This raises the Rug Renovator to its maximum height. Lower the Rug Renovator a step at a time by depressing the Toe Touch Control (cleaner "off") position. Depress the Toe Touch Control as many times as it is necessary until the brush roll will just start to rub on the carpet as you move the Kirby back and forth. When the proper setting for the Toe Touch Control has been determined, turn Belt Lifter to the "on" position. You are now ready to begin shampooing. Keep the control at this setting for your type of carpet. If different carpet is shampooed, repeat adjustment to get proper setting.

Depositing Suds

Start the Kirby motor. Shampoo suds will start to flow down the transparent hose through Renovator Tray to the rug. Push and pull the unit slowly back and forth with overlapping strokes. Do not allow renovator to

sit in one spot or allow suds to build up. A thin layer of suds the entire width of the tray will be seen on the back stroke of the Rug Renovator if the height is properly adjusted. If suds accumulate in front of tray, move the unit faster; if width of suds left on rug is not as wide as the tray, move unit slower. The dirt and spent suds will be deposited in the tray, the rug surface will be slightly damp after shampooing, and some residual light suds may remain. Rug Protector Pads furnished must be placed under all legs of furniture to protect against rust stains.

When the surface has become dry, the shampoo will turn to a dry residue that has absorbed the dirt. This can be easily removed and the nap of the rug brushed up with a thorough vacuuming with the Kirby that has the Rug Nozzle attached to it.

Cleaning Rug Renovator

It is important for good operation that the Rug Renovator be cleaned after each use.

Remove the hose from the tank. Remove the tank from the "blower" connection of the Kirby power plant, then remove the sponge air filter and slip the Suds-O-Screen off the tank. Rinse the sponge filter and Suds-O-Screen under running water. Remove the tray and nozzle assembly from the power plant. Release the belt from the Belt Lifter finger and remove the tray from the Renovator Nozzle. Rinse the tray under a water faucet to remove the dirty suds and lint, being careful not to immerse the complete brush in water. Open the hinged shelf and remove the dirt and lint. Shake any excessive water from the brush before re-using or storing the unit.

When storing the Rug Renovator, be sure the belt is not left up on the Belt Lifter finger. Leaving the belt on the Belt Lifter finger will cause the belt to stretch and result in slippage when next used.

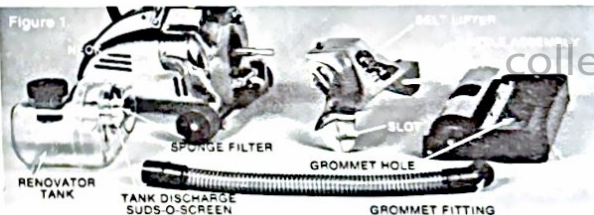

How to use the Miracle Head

WARNING: ALWAYS UNPLUG POWER CORD FROM WALL OUTLET AND BE SURE KIRBY MOTOR & FAN HAVE STOPPED BEFORE CHANGING UNITS.

The Miracle Head polishes all hard surfaced floors right up to the baseboard and into corners without leaving unsightly streaks or swirls. It may also be used as a Rug Fluffer to raise the nap of rugs or carpeting, however it should not be used on long shag rugs or carpeting.

Assemble the Kirby as an upright cleaner (see pages 8 and 9), with the exception of the Rug Nozzle. In its place, attach the Miracle Head Nozzle. Attachment procedure is the same as the Rug Nozzle. (See pages 6 and 7.)

Apply wax to the surface to be protected following the instructions for the Handi-Waxer (see page 23). Set the Toe Touch Control to the lowest (No. 1) position. Tilt the handle to the normal cleaning position and hold it tightly while you turn the motor

on. Keep a firm grip on the handle to keep the cleaner from pulling away from you. The powerful brush of the Miracle Head will quickly polish your waxed floors to the highest possible luster.

To maintain the condition of your Miracle Head and receive the maximum benefits from it, use it for polishing floors on which you have used the Kirby Handi-Waxer Wax only.

The Miracle Head will neatly polish a cove molding or a six inch baseboard by pushing the handle down against the Tilt Latch (see page 10) which will raise the brush.

When storing the Miracle Head Nozzle, detach it from the Kirby, relieve the belt tension by turning the Belt Lifter around to unlock the belt which will avoid permanent stretching of the belt material. Stretching of the belt over a long time storage span may cause the belt to become lifeless and result in slippage.

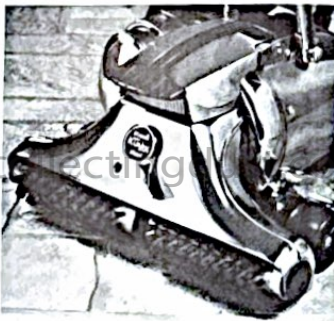

How to use the Handi-Waxer

The Kirby Handi-Waxer is designed to fit your Kirby Extension Tubes (see figure 1) and provide a wide-swath wax applicator in a convenient size package. A cover for the applicator pad helps to prevent the wax in the applicator from drying out when not in use. Each Handi-Waxer contains a ½ pound package of Kirby Emulsion Wax. It is safe to use on any type of linoleum, asphalt, vinyl, rubber, cork tile or finished wood floors.

It is designed for use with the Kirby Miracle Head and gives you all the qualities of a hard, long-lasting, slip-resistant wax. When purchased, the Handi-Waxer is preloaded with a ½ pound package of Handi-Waxer Wax.

To reload the Handi-Waxer, release the retainer spring wire, remove top, and expended wax pouch, and insert new pouch of Handi-Wax. Replace top and retainer spring wire. To use Handi-Waxer, remove bottom cover and use sharp knife to slit Handi-Wax pouch through the slot in the bottom of Handi-Waxer. The exten-

sion tubes plug into the top and serve as your handle for operating the waxer. Apply light, even coat of Handi-Waxer Wax to floor.

Convenient step pads are provided on the Handi-Waxer to assist in removal of the extension tube, and to enable you to feed wax to the pad by applying pressure with a foot. Simply step on a pad when wax is required. To avoid breakage of extension tube end, make certain end of extension tube is inserted all the way into Handi-Waxer unit. Store wax and applicator in cool, dry place. Always keep cover on bottom of Handi-Waxer, when not in use. Should felt pad on bottom of Handi-Waxer become hard, it may be softened with application of water.



WARNING: ALWAYS UNPLUG POWER CORD FROM WALL OUTLET AND BE SURE KIRBY MOTOR & FAN HAVE STOPPED BEFORE CHANGING UNITS.

WARNING: ALWAYS WEAR SAFETY GLASSES WHEN USING WORK WHEELS AND SAW.

To assemble the Handi-Butler attach Handi-Butler unit to front of power plant following instructions on pages 6 and 7. Attach Sani Em-Tor and Filter Bag, cord and Portable Handle to motor unit. If you plan to use the Handi-Butler as a stationary unit, for polishing and sanding, place rubber cups under front wheels of motor unit.

If Handi-Butler is to be used as a portable unit, attach Shoulder Strap as explained on page 20.

The Buffing Wheels and Jig Saw may be attached directly to the Handi-Butler itself, or to the end of the Flexible Shaft.

To attach to the Handi-Butler grasp the desired Buffing Wheel and insert the wheel shaft into the drive shaft opening on front of Handi-Butler. The magnetic clutch will hold the wheel firmly in place. To remove, grasp wheel with fingers and pull firmly away from the drive shaft. The Jig Saw attaches to the Handi-Butler in the same manner. When used on the Handi-Butler itself, the blade of the Jig Saw should point up. When using Jig Saw on Handi-Butler, place rubber cups under rear wheels, and one rubber cup under handle knob of Jig Saw, then lower Toe Touch Control to further steady Jig Saw on Handi-Butler.

To attach Sanding Disc or Polishing Pad to Flexible Shaft, it is necessary to first attach Drill Chuck into the end of the Flexible Shaft. Insert Disc shaft into the Drill Chuck and tighten.

It is not necessary to use pliers or a wrench when tightening or loosening the Drill Chuck. Simply press the small shaft locking button, located in the grip, into one of the slots in the magnetic

clutch plate. This acts as a wrench and holds the shaft while tightening or loosening the chuck.

With the Drill Chuck attached and locked to the shaft of the rubber Disc (to which the Polishing Pad or Sanding Disc has been applied) these work tools may then be attached directly to the front of the Handi-Butler itself.

Saber Saw

WARNING: ALWAYS UNPLUG POWER CORD FROM WALL OUTLET AND BE SURE KIRBY MOTOR & FAN HAVE STOPPED BEFORE CHANGING UNITS.

The Saber Saw is used with the Flexible Shaft. Simply insert drive shaft of Saber Saw directly into the end of the Flexible Shaft and turn until it locks in place. The handle knob of the Saber Saw is designed to provide greater freedom of movement and ease of use.

The Jig - Saber Saw comes with a 10T high speed steel "scroll" blade for fine woodcutting and cutting plastic of 3/4" or thinner. Cut with a light even pressure to avoid stalling. The Jig - Saber Saw uses standard uni-shank blades designed for 3/4" shank saws. To change blades use screwdriver to turn screw near point of blade entry into Jig - Saber Saw. Pull out blade, insert new blade and tighten screw.

Flexible Shaft

To attach Flexible Shaft to Handi-Butler, grasp the knurled collar of the bayonet connection and insert the core wire into the small hole at the rear of the Handi-Butler housing. Align the slots in the collar with the pins on the housing and with a firm forward pressure, twist to the right, the connection will lock firmly in place.

A slight rotation of the Handi-Butler drive shaft may be needed to engage with the drive shaft.

WARNING: CAUTION SHOULD BE TAKEN TO BE SURE HAND GRIP OF SHAFT IS HELD IN THE HAND WHENEVER THE MOTOR UNIT IS TURNED ON.

The Flexible Shaft is designed for use only on the Kirby Handi-Butler.

Polishing and Buffing

The Polishing Pad is stretched over the rubber Disc and fastened by drawing the strings tight and tying. Be sure to tuck the loose ends under the edge of the pad. This pad is ideal for polishing waxed surfaces such as table tops, shoes and automobiles.

The sewn Sheeting Buffing Wheel (the harder of the two Buffing Wheels, and which may be further identified by the stitching on the sides) is used with red polishing compound No. 1 for polishing brass, copper or similar metals.

The Flannel Buffing Wheel (the softer of the two Buffing Wheels provided) is used with the light-colored polishing compound No. 2 for polishing precious metals such as gold or silver.

The polishing compounds are applied to the Buffing Wheel by holding the stick against the rotating wheel. Use sparingly. Compounds contain oils, grease and abrasive materials and should be stored in a cool place. Keep out of reach of children.

WARNING: ALWAYS WEAR SAFETY GLASSES WHEN USING WORK WHEELS.

Sanding

Sanding Discs have a self-adhesive coating on the back. To use peel off protective paper, and adhere desired sanding disc to rubber disc.

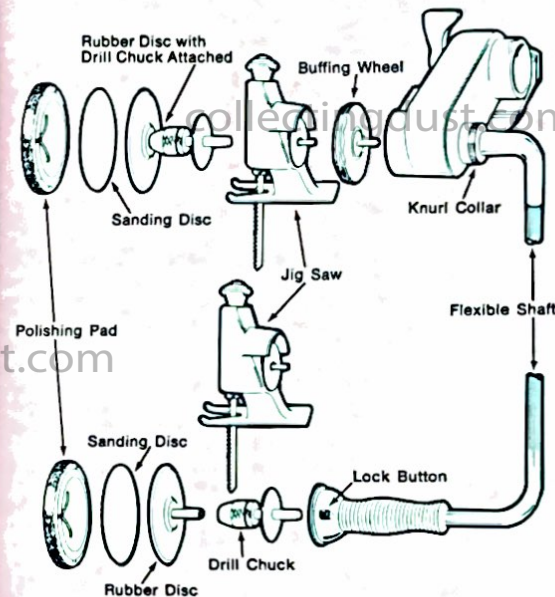

Helpful home service tips

WARNING: ALWAYS UNPLUG POWER CORD FROM WALL OUTLET AND BE SURE KIRBY MOTOR & FAN HAVE STOPPED BEFORE CHANGING UNITS.

If Kirby will not pick up lint or ravelings on carpet, check to see if:

1. Belt Lifter is in "OFF" position (Page 6).
2. Belt is broken or worn out (Page 28).
3. Brush needs adjustment (Page 27).
4. Toe Touch Nozzle Adjustment is improperly adjusted (Page 10).
5. Filter Bag needs emptying (Page 11).
6. Brush needs cleaning (Page 27).

If motor will not run and light does not light:

1. Check to make sure cord is properly plugged into the Kirby and wall outlet.
2. Make visual inspection of cord to make sure there are no breaks in cord and it is fully covered by insulation. Pay particular attention to male and female connectors at ends of cord.
3. Make sure that the Rug Nozzle, Crystalator, Handi-Butler, Miracle Head, Hose or Rug Renovator is properly in place on the front of the power plant.
4. Check your wall switch to make sure power is on at wall socket.

If Rug Nozzle is loose even after proper attachment:

1. Attachment lock not turned tight enough.

If Sani Em-Tor is loose:

1. Check to be sure it is locked in position by turning clockwise as far as possible (see page 8).
2. Check to see if rubber gasket inside collar of Sani Em-Tor is properly in place.

If Miracle Head brush will not revolve:

1. Make sure Belt Lifter is in "ON" position and over the power plant pulley.
2. Check condition of belt — replace if necessary. (See page 28.)
3. Make sure belt is not wet with wax.

If Handi-Butler work wheels will not revolve or stop under light pressure:

1. Make sure Belt Lifter is in "ON" position.
2. Check belt and replace if broken, worn, or stretched. (see page 29.)

If dirt will not fall out of bag and Sani Em-Tor:

1. Too much dirt has been allowed to accumulate and it is jamming the large opening of the Sani Em-Tor where the bag is attached. Use Sani-Scraper in Sani-Pocket to clean bag and force dirt into Sani Em-Tor. (See page 11.)

If Kirby is hard to push when Rug Nozzle is attached:

1. Toe Touch Nozzle Attachment set too low. Raise one or two notches. (Page 10.)

More helpful home service tips

WARNING: ALWAYS UNPLUG POWER CORD FROM WALL OUTLET AND BE SURE KIRBY MOTOR & FAN HAVE STOPPED BEFORE CHANGING UNITS.

Brush Adjustment and Cleaning

Through usage, the revolving brush in the Rug Nozzle will gradually wear down. When it fails to protrude approximately 1/16 inch beyond the stainless steel rug guard — check by laying a flat piece of stiff cardboard across a portion of the rug guard — turn the Brush Roll Adjustment Screws at each end of the Brush Roll clockwise with a screwdriver (See Figure 1) until the proper amount of bristle protrudes. Be sure to turn each screw an equal amount so the same amount of bristle protrudes on each end of the Brush Roll.

To Remove Brush Roll from Rug Nozzle

1. Remove nozzle from power plant.
2. Turn Belt Lifter to "ON" position to release belt from Belt Lifter Finger.
3. Swing Rug Guard from nozzle, on hinges as shown.
4. Spread Support Brackets by bending slightly away from Brush Roll. The brush may then be removed for cleaning.
5. Use scissors to cut string, thread, or hair which may be wrapped around the Brush Roll. An old comb is also useful in removing foreign matter embedded in brush tufts.

Replacement of Brush Roll

1. Place ends of Brush Roll into Rug Guard Support Brackets — one end is wider than the other so it can be replaced the correct way.
2. Bend the Support Brackets back into place.
3. Make sure belt is positioned in center of Brush Roll.
4. Swing Brush Roll Assembly into nozzle. Make sure Rug Guard Rim is seated firmly all around the edge of the nozzle.



FIGURE 1

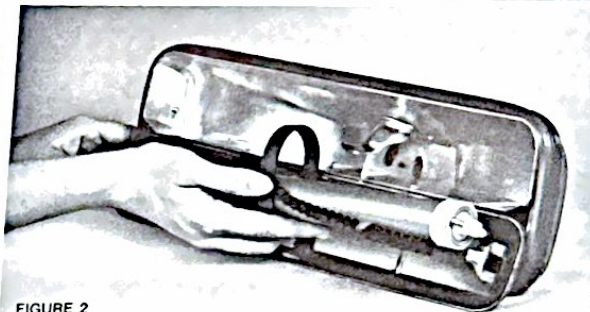

FIGURE 2

Belt Replacement Rug Renovator

1. Remove the Renovator Nozzle Assembly and the Tray Assembly from the motor unit.
2. Release the belt from the Belt Lifter.
3. Remove the Renovator Tray from the nozzle assembly.
4. Remove the screw and plastic bumper from both sides of the Tray using a Phillips screwdriver.
5. Remove belt by sliding it out over the end of the Brush Roll.
6. Install new belt by reversing above steps.



Rug Nozzle

If the Rug Nozzle fails to remove lint from the surface of the carpet, the cause of the difficulty may be a weak or broken belt.

1. Remove the Rug Nozzle from the power plant.
2. Remove the Brush Roll from the Rug Guard as explained on page 27.
3. Remove belt by sliding it out over the end of the Brush Roll.
4. Install new belt by reversing above steps.

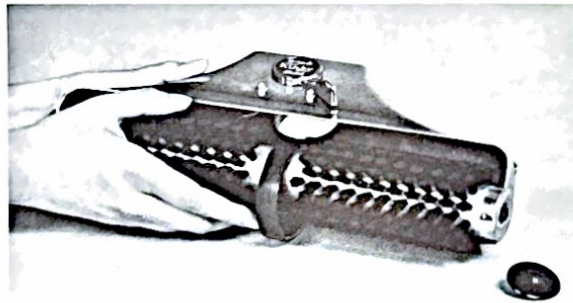

Miracle Head

1. Remove the Miracle Head from the power plant.
2. Turn the Belt Lifter to "ON" position.
3. Loosen screw at one end of nozzle about a half turn with a Phillips screwdriver.
4. Remove the screw and rubber bumper from the other end.
5. Swing the Brush Roll out slightly being careful not to bend axle or remaining screw.
6. Remove belt by sliding it out over the open end of the Brush Roll.
7. Install new belt by reversing above steps.

Handi-Butler

1. Remove Handi-Butler from power plant.
2. Remove work attachments.
3. Turn Belt Lifter to "ON" position.
4. With screwdriver remove three screws from the back of the frame.
5. Lift back frame off. Belt will come off.
6. Install new belt and reassemble.
7. With screwdriver, hook belt over magic finger.

Bulbs/Cord/Filter Bag/Lubrication

Your Kirby motor has been properly lubricated at the Factory and should not need additional lubrication for several years. If additional lubrication is required, *safety precautions require that any repairs calling for the removal of the motor shell must be done only by qualified Kirby authorized service personnel*

Filter Bag Maintenance

Keep the plastic Bag Guard in place around the point where the bag is fastened to the Sani Em-Tor. This will minimize wear, and under average use, your bag will last for many years. The only time it will need replacement will be at times of general overhaul. The bag is fastened to the Sani Em-Tor with a strong spring, and reasonable strength and skill is required for its replacement.

Bulb Replacement

Access to the headlight is gained by removing the two screws which hold the lens cover in place. The headlight bulb is held in the socket with a conventional bayonet base fitting. To assure continuing safety benefits of Kirby's double insulated motor, it is necessary that bulb replacement be done only by qualified Kirby authorized service personnel.



IMPORTANT

THE KIRBY GENERAL SERVICE INSURANCE, COVERAGE OF LOSS BY FIRE, AND LIMITED WARRANTY DESCRIBED BELOW ARE EACH NULL AND VOID IF (1) THE KIRBY WAS NOT PURCHASED FROM AN INDEPENDENT AUTHORIZED KIRBY DISTRIBUTOR, AREA DISTRIBUTOR, OR DEALER WHO SIGNED PAGE 31 OF THIS WARRANTY AND INSTRUCTION BOOK AND FILLED IN THE DATE AND SERIAL NUMBER, OR IF (2) THE NAME PLATE OR SERIAL NUMBER OF THE KIRBY HAS BEEN DEFACED, REMOVED, OR CHANGED (OTHER THAN BY FIRE OR OTHER CASUALTY OR ACCIDENT, OR IN CONNECTION WITH FACTORY AUTHORIZED REBUILD).

PROTECT YOUR RIGHTS MAKE SURE YOU ARE (1) PURCHASING FROM AN INDEPENDENT AUTHORIZED KIRBY DISTRIBUTOR, AREA DISTRIBUTOR, OR DEALER, AND (2) PAGE 31 IS FILLED IN AND SIGNED, AND (3) THE ORIGINAL NAME PLATE AND SERIAL NUMBER ARE INTACT.

GENERAL SERVICE INSURANCE

Subject to the conditions and exceptions stated below, The Kirby Company Division of The Scott & Fetzer Company ("Company") hereby agrees with the original purchaser (other than for purposes of resale) of a new Kirby to entirely rebuild and re-condition the Kirby, as often as may be required, provided it is still owned by and in the possession of the original purchaser, and provided it is returned, transportation prepaid, to the Company's factory in Cleveland, Ohio 44102, subject to the following:

1. The Company, in rebuilding and re-conditioning the machine for the original purchaser, will make every effort to keep the cost to such purchaser for this service as low as possible and the Company will in no case charge such purchaser more than \$49.50 for any one rebuild.
2. The Company's maximum price of \$49.50 shall include all labor and cost of all parts (except for broken or missing parts) necessary to put the Kirby in A-1 condition.
3. All transportation charges, and replacement costs of broken parts or missing parts, shall be paid for by the purchaser.
4. THE GENERAL SERVICE INSURANCE IS NULL AND VOID IF (1) THE KIRBY WAS NOT PURCHASED FROM AN INDEPENDENT AUTHORIZED KIRBY DISTRIBUTOR, AREA DISTRIBUTOR OR DEALER WHO SIGNED PAGE 31 OF THIS WARRANTY AND INSTRUCTION BOOK AND FILLED IN THE DATE AND SERIAL NUMBER, OR (2) THE NAME PLATE OR SERIAL NUMBER OF THE KIRBY HAS BEEN DEFACED, REMOVED, OR CHANGED (OTHER THAN BY FIRE OR OTHER CASUALTY OR ACCIDENT, OR IN CONNECTION WITH FACTORY AUTHORIZED REBUILD).

COVERAGE OF LOSS BY FIRE

Subject to the conditions and exceptions stated below, The Kirby Company Division of The Scott & Fetzer Company ("Company") agrees with the original purchaser (other than for purposes of resale) of a new Kirby that in the event that the Kirby, while owned by and in the possession of the original purchaser, should be damaged or destroyed by fire, on the premises of such purchaser, the Company will repair or rebuild the Kirby for such purchaser and return it in A-1 condition, provided that such purchaser sends \$49.50 and the fire damaged remains, transportation prepaid, to the Company's factory in Cleveland, Ohio 44102 within ninety (90) days after the date of the damaging fire. If the cost of labor and parts necessary to repair or rebuild the Kirby should be less than \$49.50, the difference between such cost and \$49.50 shall be returned to such purchaser by the Company.

If, while owned by and in the possession of the original purchaser, the Kirby Miracle Head, Handi Butler, Flexible Shaft, Miracle Waxer, Rug Renovator, or cleaning tools are damaged or destroyed by fire, on the premises of such purchaser, the Company will replace any such item, provided that such purchaser sends the appropriate amount indicated below and the fire damaged remains, transportation prepaid, to the Company's factory in Cleveland, Ohio 44102 within ninety (90) days after the date of the damaging fire: the Kirby Miracle Head, \$9.00, the Kirby Handi Butler and Flexible Shaft, \$21.50, the Kirby Handi-Waxer, \$5.00, the Kirby Rug Renovator, \$18.00, and cleaning tools, \$12.00.

In the event that the Kirby, Miracle Head, Handi Butler, Flexible Shaft, Miracle Waxer, Rug Renovator, or cleaning tools, while owned by and in the possession of the original purchaser, shall be completely and wholly destroyed by fire, on the premises of such purchaser, so that no

damaged remains can be returned, an affidavit, sworn to by the original purchaser before a notary public, affirming such complete destruction, must be furnished within ninety (90) days after the date of the damaging fire in lieu of damaged remains, and the destroyed item will be replaced under the terms set forth above.

All transportation charges shall be paid by the purchaser.

THE COVERAGE OF LOSS BY FIRE IS NULL AND VOID IF (1) THE KIRBY WAS NOT PURCHASED FROM AN INDEPENDENT AUTHORIZED KIRBY DISTRIBUTOR, AREA DISTRIBUTOR, OR DEALER WHO SIGNED PAGE 31 OF THIS WARRANTY AND INSTRUCTION BOOK AND FILLED IN THE DATE AND SERIAL NUMBER, OR (2) THE NAME PLATE OR SERIAL NUMBER OF THE KIRBY HAS BEEN DEFACED, REMOVED, OR CHANGED (OTHER THAN BY FIRE OR OTHER CASUALTY OR ACCIDENT, OR IN CONNECTION WITH FACTORY AUTHORIZED REBUILD).

LIMITED WARRANTY

Subject to the conditions and exceptions stated below, The Kirby Company Division of The Scott & Fetzer Company ("Company") warrants to the original purchaser (other than for purposes of resale) that each Kirby product shall be free from defects in material and workmanship under normal use and service, as follows: (a) for two (2) years from the date of purchase by the original purchaser when used for personal, family, or household purposes ("consumer purposes"); (b) for one (1) year from the date of purchase by the original purchaser when used for commercial, professional, rental, institutional, etc. purposes ("commercial purposes"). At any time during the applicable warranty period, the Company will furnish for the Kirby product a replacement part for any part returned to and found by the Company to be defective. Such replacement part will be furnished through an authorized Kirby service center or to the Company's factory, at the Company's election. The purchaser must return the Kirby product or part claimed to be defective to any authorized Kirby service center or to The Kirby Company, located at 1920 West 114th Street, Cleveland, Ohio 44102. All transportation expenses must be borne by the purchaser. This Limited Warranty does not apply to belts, light bulbs or other expendables, such as, buffing pads, compounds, etc., charges for labor or service calls, damage caused by accident, misuse, negligence, abuse, or to any Kirby product which has been repaired so as in the judgment of the Company to affect its stability or reliability, or in which parts not approved by the Company shall have been used. In approving the Kirby for double insulation, Underwriters' Laboratories requires that only identical parts should be used in servicing the sealed motor unit.

The foregoing provisions state the exclusive remedy for any breach of warranty or any other claim in respect of any Kirby product. THERE IS

NO OTHER EXPRESS WARRANTY IMPLIED WARRANTIES, INCLUDING THOSE OF MERCHANTABILITY AND FITNESS FOR A PARTICULAR PURPOSE ARE LIMITED TO TWO (2) YEARS FROM THE DATE OF PURCHASE BY THE ORIGINAL PURCHASER, IN THE CASE OF KIRBY PRODUCTS USED FOR CONSUMER PURPOSES, AND TO ONE (1) YEAR FROM THE DATE OF PURCHASE BY THE ORIGINAL PURCHASER, IN THE CASE OF KIRBY PRODUCTS USED FOR COMMERCIAL PURPOSES. THIS IS THE EXCLUSIVE REMEDY, AND ANY LIABILITY FOR INDIRECT OR CONSEQUENTIAL DAMAGES, OR FOR ANY INCIDENTAL EXPENSES, IS EXCLUDED. Some states do not allow limitations on how long an implied warranty lasts, or do not allow the exclusion or limitation of incidental or consequential damages, so the above limitation may not apply to you.

The Company neither assumes, nor authorizes any other person to assume for it, any additional liability in connection with the sale of its products.

THIS LIMITED WARRANTY IS NULL AND VOID IF (1) THE KIRBY WAS NOT PURCHASED FROM AN INDEPENDENT AUTHORIZED KIRBY DISTRIBUTOR, AREA DISTRIBUTOR OR DEALER WHO SIGNED PAGE 31 OF THIS WARRANTY AND INSTRUCTION BOOK AND FILLED IN THE DATE AND SERIAL NUMBER, OR IF (2) THE NAME PLATE OR SERIAL NUMBER OF THE KIRBY HAS BEEN DEFACED, REMOVED, OR CHANGED (OTHER THAN BY FIRE OR OTHER CASUALTY OR ACCIDENT, OR IN CONNECTION WITH FACTORY AUTHORIZED REBUILD).

This Limited Warranty gives you specific legal rights, and you may also have other rights which vary from state to state.

THE KIRBY COMPANY
DIVISION OF THE SCOTT & FETZER COMPANY
CLEVELAND, OHIO

Manufacturers of the Kirby Classic III
ADRIAN E. BUDLONG, Jr.
President and Chief Executive Officer

Service calls, including those during the warranty period, will be at the expense of the owner.

PLEASE COMPLETE THE FOLLOWING

The above warranty covers the Kirby Classic III.

Serial No. _____

Date of Delivery _____

Authorized Dealer Signature _____

Odorific

Odorific is an all-purpose deodorizer that neutralizes odors and provides instantaneous, economical and long-lasting results. It is *not* a masking perfume that simply covers up unpleasant odors with a more pleasant scent. One ¼ ounce "tap-a-drop" bottle of Odorific is packed with every Kirby One drop of Odorific is enough to neutralize the odors in a 1,000 cubic foot area for a 24-hour period. Use sparingly because every drop is effective. Odorific will act fastest when used in a manner that will speed its evaporation, such as on a warm surface, or in an air current from a window or air conditioning unit. Odorific is non-toxic and safe to use. In event of contact with eyes, flush with water. It may discolor certain plastic, rubber or paint surfaces.

Use to neutralize odors created by cooking, pets, lavatories, garbage, paint, etc. One drop of Odorific in the Kirby Filter Bag neutralizes any odors from the Filter Bag. Apply to cotton ball and turn on Kirby upright cleaner and pick up cotton ball on which Odorific has been applied.

Scuttle

Scuttle is a superior all-purpose cleaner which is pleasant-smelling, economical, easy and safe to use. Just spray on Scuttle and wipe dirt and grease off windows, tile, appliances, walls, painted woodwork, chrome, stainless steel, mirrors, vinyl, plastic, porcelain — and a wide variety of other materials and items.

For tough jobs, stubborn areas, heavy built-up soil, textured washable surfaces, heel marks, etc., spray on Scuttle, let it stand for a few seconds, then lightly scrub with pre-wet soft bristle brush. Wipe with damp cloth and follow-up with a dry cloth.

Use Scuttle to boost the cleaning power of Kirby Instant Suds when renovating heavily soiled rugs or carpeting. Add one tank cap measure of Kirby Scuttle to suds solution in Rug Renovator Tank, or spray directly on spot just before shampooing. Scuttle is non-toxic and safe to use, and gentle to hands. If sprayed in eyes, flush with water.

Instant suds

Kirby Instant Suds is especially formulated for use with the Rug Renovator and Suds-O-Gun. The combination of cleaning power, resoiling resistance, mildew preventative and fabric brightener makes it an outstanding rug and upholstery shampoo.

A 12 ounce bottle is included with the Rug Renovator. Directions for using Instant Suds are included on the label PRIOR TO USING ON ANY FABRIC CHECK FOR COLOR FASTNESS BY APPLYING SMALL AMOUNT TO MATERIAL IN AREA WHERE IT WILL NOT SHOW, ALLOWING IT TO DRY AND OBSERVING THE RESULTS BEFORE PROCEEDING FURTHER. Also check to determine water spot resistance and effect on materials such as velvet, brocades, etc.

Handi-Waxer Wax

Handi-Waxer Wax is specially formulated for use with the Handi-Waxer. It is a slip-resistant emulsion wax safe to use on any type of linoleum, asphalt, vinyl, rubber or cork tile, or wood floors. One hundred percent of the natural wax is number one Carnauba. Apply light even coat to floors with Handi-Waxer. The wax dries with a dull appearance. Drying time depends on the thickness of the coating and atmospheric conditions. Unlike waxes with hazardous volatiles, additional drying time does not affect the final results. You can polish it with the Miracle Head hours after application.

A ½ pound package of Handi-Waxer Wax is included with the Kirby Handi-Waxer.

Availability

Kirby Odorific, Scuttle, Instant Suds and Handi-Waxer Wax are available from independent Kirby Dealers, Area Distributors and Distributors. In addition to the 12 ounce bottles with finger-type sprayer, Scuttle is also available in 32 ounce refill bottles without the sprayer. Instant Suds is available in 12 ounce bottles, quarts and gallons. Handi-Waxer Wax is available in packages of two ½ pound pouches per package.



IMPORTANT CONSUMER NOTICE

The Kirby Company has a vital interest in seeing that proper sales techniques are used in the demonstration and sale of its products. Kirby salespeople have been required not to use improper sales techniques in areas such as those listed below. Please answer the following sales technique questions, and return this postage-paid reply card to The Kirby Company. Please wait for a day or longer after your purchase before completing this card.

SIGNATURE _____ DATE _____
 NAME _____ TELEPHONE _____
 ADDRESS _____ DATE OF PURCHASE _____
 KIRBY SERIAL NO. _____
 SALESPERSON'S NAME _____
 DISTRIBUTOR'S NAME _____
 DISTRIBUTOR'S ADDRESS _____

- | | YES | NO |
|--|--------------------------|--------------------------|
| 1. At the outset of the first in-home contact, did the salesperson: | <input type="checkbox"/> | <input type="checkbox"/> |
| a. Inform you that the purpose of the contact was to demonstrate and interest you in buying Kirby products? | <input type="checkbox"/> | <input type="checkbox"/> |
| b. Give you a business card? | <input type="checkbox"/> | <input type="checkbox"/> |
| 2. Sellers of Kirby products have been instructed not to represent that you were "specially selected." Did the salesperson comply with that instruction? | <input type="checkbox"/> | <input type="checkbox"/> |
| 3. Sellers of Kirby products have been instructed not to represent that they were conducting a survey or quiz. Did the salesperson comply with that instruction? | <input type="checkbox"/> | <input type="checkbox"/> |
| 4. Was the time required for the demonstration substantially as represented? | <input type="checkbox"/> | <input type="checkbox"/> |
| 5. If any promises were made by the salesperson, have they been completely fulfilled? | <input type="checkbox"/> | <input type="checkbox"/> |
| 6. Did the salesperson explain what costs you bear and what responsibilities The Kirby Company bears under its factory rebuild service? | <input type="checkbox"/> | <input type="checkbox"/> |
| 7. "Buyer's Right of Cancellation?" | <input type="checkbox"/> | <input type="checkbox"/> |
| 8. Did you receive all accessories listed on your sales contract? | <input type="checkbox"/> | <input type="checkbox"/> |
| 9. If you answered any of the questions 1-8, did you do so: | <input type="checkbox"/> | <input type="checkbox"/> |
| a. without any instruction from the salesperson? | <input type="checkbox"/> | <input type="checkbox"/> |
| b. after the salesperson left your home? | <input type="checkbox"/> | <input type="checkbox"/> |

IF YOU HAVE ANY COMMENT OR COMPLAINT, PLEASE INDICATE BELOW:

FIRST CLASS
PERMIT NO. 17772

CLEVELAND, OHIO

BUSINESS REPLY MAIL No postage stamp necessary if mailed in the United States

POSTAGE WILL BE PAID BY

The Kirby Company
1920 West 114 Street
Cleveland, Ohio 44102



Home of the Kirby is a modern plant in Cleveland, Ohio which is devoted exclusively to the design, manufacture and testing of the Kirby.



The newest Kirby manufacturing facility is a 96,000 sq. ft. plant in Andrews, Texas.

The Kirby Company

Division of the Scott & Fetzer Company



1920 W. 114 St. / Cleveland, Ohio 44102

IN TEXAS:

Kirby West / P. O. Box 670
Andrews, Texas 79714

IN CANADA:

Kirby of Canada / 1009 Burns St. East
Whitby, Ontario L1N6A6