

the  
amazingly  
new

Kirby

# Classic

built to  
put more  
leisure time  
into your  
modern life

• WARRANTY AND INSTRUCTION BOOK



*this book*

is dedicated to you, the owners of the wonderful new Kirby. It is designed to promote your complete enjoyment of the Kirby Classic. Keep this booklet in your Accessories Box where it will be handy. Read and review it often, for by knowing your Kirby completely, you will realize full value from your purchase and appreciate the Kirby as a truly marvelous and dependable household friend.



*contents*

<b>YOUR KIRBY</b>	
What it does for you .....	Pages 2 to 5
Its parts .....	Pages 6, 7
<b>HOW TO USE YOUR KIRBY</b>	
Belt Lifter .....	Pages 8, 12
Toe Touch Control .....	Page 9
Motor Switch & Handle Lock .....	Page 10
Sani Em-Tor .....	Pages 11, 17
Swedish Massage Unit .....	Page 13
Handi Butler .....	Pages 14, 15
Handi Sharpener .....	Page 15
Upright Cleaner .....	Page 16
Suction Relief Vent .....	Page 17
Duster Buffer .....	Page 18
Miracle Head® .....	Page 18
Rug Renovator .....	Page 19
Basic Attachments .....	Page 20
Spray Gun, Suds O-Gun .....	Page 21
Portable Units .....	Pages 22, 23
Surface Nozzle .....	Page 23
Crystalator .....	Pages 24, 25
Roll O-Waxer .....	Page 26
Handi-Waxer .....	Page 31
<b>HOW TO MAINTAIN &amp; SERVICE YOUR KIRBY</b>	
.....	Pages 27 to 30
<b>INDEX</b>	Back Cover
<b>KIRBY GENERAL COVERAGE WARRANTY</b>	
.....	Pages 32, 33

Copyright 1970 Scott & Fetzer Co.

see all the  
things your  
**new**

Kirby  
**Classic**

can do...

✧ in the following pages...



**SPRAY GUN** Sprays lacquer, paint, insecticide, liquid floor wax, plus many other liquids.



**HANDI-BUTLER** A versatile power tool for grinding, sharpening, buffing, and polishing. A flexible shaft lets you take the tool to the job.



**TANK TYPE CLEANER** Plenty of air flow and suction for dustless cleaning above the floor, with utility air nozzle, utility brush nozzle, surface nozzle, duster brush and crevice tool.



**HAND PORTABLE** Deep cleans mattresses thoroughly, right on your bed. Wonderful for use on upholstered furniture, too.



**UPRIGHT CLEANER** Exclusive "Triple Cushion Vibration" plus the widest nozzle of any in-the-home cleaner gets the job done faster. More leisure time for you.



Kirby  
**Classic**

no other appliance in the world does as many things for you...



**CRYSTALATOR** A complete demisting unit. Gives you a quick, easy, safe, and sure method of control through an exclusive method of quick evaporation of para-crystals.



**SUDS-O-GUN** Generates volumes of extra dry suds, when used with Kirby Instant Suds, for the safe, efficient, and economical shampooing of rugs and upholstered furniture.



**MIRACLE HEAD®** Polishes all hard surfaced floors right up to the baseboard and into corners without leaving unsightly streaks or swirls.



**RUG RENOVATOR** Shampoos rugs and carpeting safely, and economically. Ground-in dirt, soil, and lint are efficiently removed as you shampoo with almost dry Kirby Instant Suds.

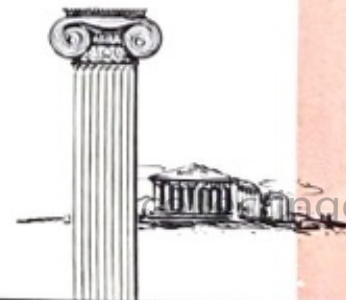

Kirby

Classic



**FLOOR DUSTER-BUFFER** Dual heavy felt pads loosen dirt and buff hard surfaced floors easily and effectively as you vacuum.



**TOE TOUCH CONTROL** Gives you eight positive adjustments to assure you the correct nozzle height for all floor coverings, including deep shag textures.

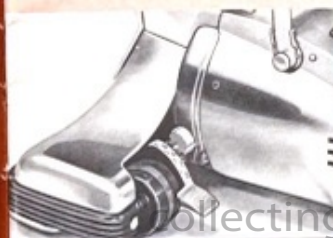

**ACCESSORIES CASE** Designed for your convenience in use and storage. Hung on a door knob or back of a chair — tools are handy for use. There's an easily identified place for everything in this container.



**SANI-EM-TOR** — Only the Kirby has Sani Em-Tor and now it's easier than ever to empty the filter bag without fuss or muss.



no other appliance is as versatile or provides so many benefits...



**SHOULDER PORTABLE** Add the shoulder strap to the floor portable and you have a unit which frees both hands for cleaning in difficult places.



**SANI-POCKET (Patented)** Permits you to scrape excess dirt from the filter bag into the Sani Em-Tor without touching dirt.

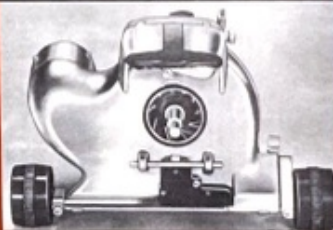

**SAFETY SPEED SELECTOR SWITCH** For maximum operating efficiency and protection against possible injury, it automatically selects proper speed when attachments are on, and stops fan when exposed.



**SWIVELED CORD HOOK** Permits you to release the 32' power cord for use simply by turning the cord hook.

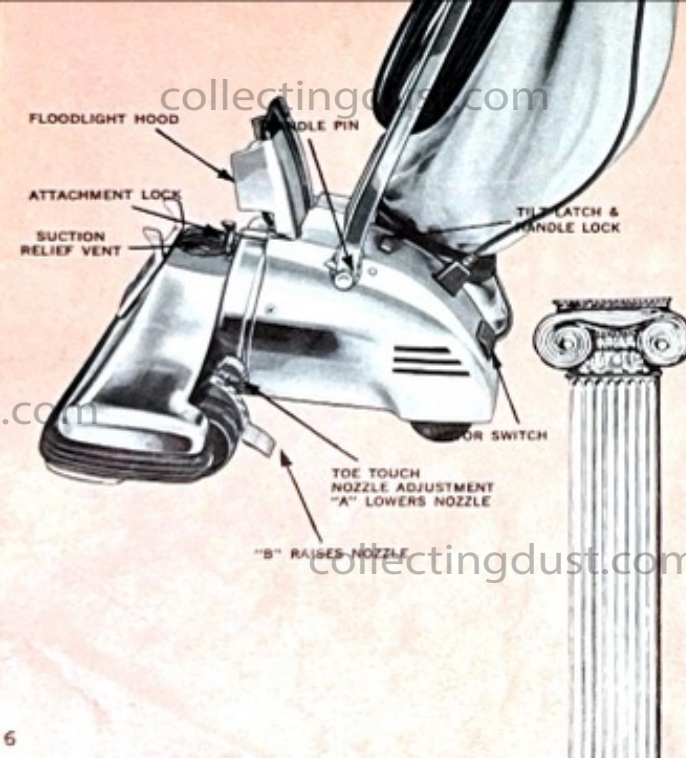

for your complete enjoyment  
 know your **Kirby** parts

- |                        |  |
|------------------------|--|
| 1. FILTER BAG          | 20. CREVICE TOOL BRUSH                 |
| 2. FILTER BAG GUARD    | 21. DUSTER BRUSH                       |
| 3. SANI EM-TOR         | 22. MASSAGE CUP                        |
| 4. FLOOR DUSTER PAD    | 23. UTILITY BRUSH NOZZLE               |
| 5. LONG HANDLE         | 24. UTILITY AIR NOZZLE                 |
| 6. BELT                | 25. CRYSTALATOR                        |
| 7. BRUSH ROLL          | 26. SURFACE NOZZLE — SWIVEL ATTACHMENT |
| 8. BELT LIFTER         | 27. HANDI-WAXER                        |
| 9. SUCTION RELIEF VENT | 28. CREVICE TOOL                       |
| 10. RUG NOZZLE         | 29. STRAIGHT EXTENSION TUBE            |
| 11. PORTABLE HANDLE    | 30. CURVED EXTENSION TUBE              |
| 12. HANDI-SHARPENER    | 31. SPRAY & SUDS O-GUN                 |
| 13. HANDI-BUTLER       | 32. HOSE COUPLER                       |
| 14. SHOULDER STRAP     | 33. FLEXIBLE HOSE                      |
| 15. HANDLE PIN         | 34. SWIVELED COUPLER TUBE              |
| 16. MIRACLE HEAD®      | 35. RUG RENOVATOR                      |
| 17. CORD               | 36. ROLL-O-WAXER                       |
| 18. FLEXIBLE SHAFT     |  |
| 19. MOTOR UNIT         |  |



## MAGIC FINGER belt lifter

### FOR EASY CHANGING OF UNITS

The magic finger belt lifter makes it easy for you to change from use of the rug nozzle, Miracle Head®, Rug Renovator, and Handi-Butler. The belt transmits power from the motor to the Kirby unit. To change units, the belt must be removed from the belt drive shaft (motor pulley) and replaced with the belt of another unit. The belt lifter does this for you without you having to touch the belt.

### BELT LIFTER DIAL

The belt lifter on the rug nozzle has an indicating dial which shows you the position of the "magic finger." When the belt lifter is in the usual position for operating the cleaner, the words "Belt

is On" appear in the window. When you rotate the belt lifter, the window reveals arrows indicating the direction to turn the belt lifter for the belt to be "on" or "off" the motor pulley. When you have turned the belt lifter through its complete turn, the words "Belt is Off" appear in the window. The belt is now removed from the motor pulley and the nozzle can be removed from the motor unit.

### BELT LIFTER ON EACH UNIT

The belt lifter on the Miracle Head®, Rug Renovator, and Handi-Butler work in the same way, and stops are provided so that at one end of the allowed travel, the belt is in the "on" position, and at the other end, the belt is in the "off" position.



## how to use the TOE TOUCH CONTROL

The exclusive Kirby toe touch control enables you to adjust the rug cleaning nozzle to the proper height for efficient cleaning of all floor coverings from the thickest to the thinnest.

If the nozzle is too high above the floor covering, the air will enter the nozzle above the surface to be cleaned. If the nozzle is set too low, the air cannot get into the nozzle. In either instance, the cleaning action will be impaired. It is important to have the nozzle position just right for each thickness of floor covering.

To adjust the Kirby rug nozzle properly for your rug, simply depress the large lever (see "B" in illustration) with your toe as far as it will go.

This raises the nozzle to the maximum height and the pointer will indicate No. 7 on the adjustment scale.

Now turn on the motor and depress button "A" with your toe. Each time you depress this button, the nozzle will lower one notch. Continue to depress this button one notch at a time until you notice a change in the sound of your Kirby. This indicates that the nozzle is at the correct level for the thorough cleaning of your carpet.

If the suction is broken with normal movement of the Kirby, lower the nozzle one more notch.

This same adjustment is used when operating the Handi-Butler, the Miracle Head®, or the Rug Renovator.

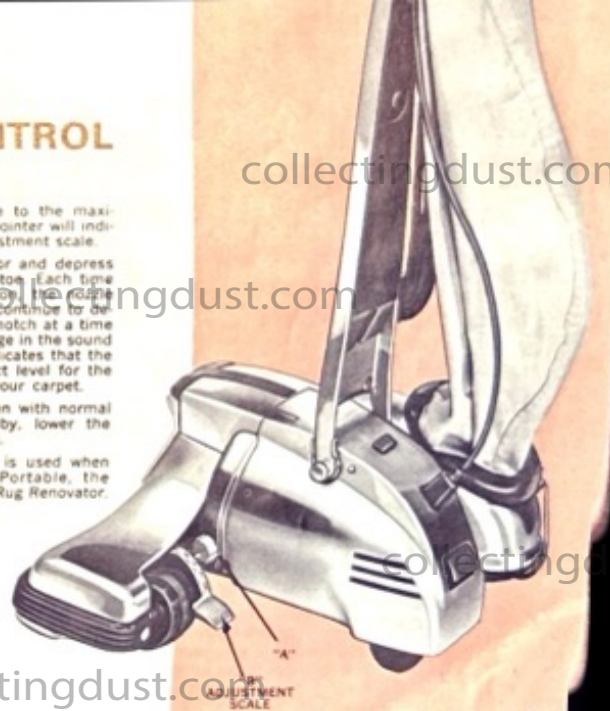

## \* Tilt Latch

## \* Handle Lock

## \* Motor Switch

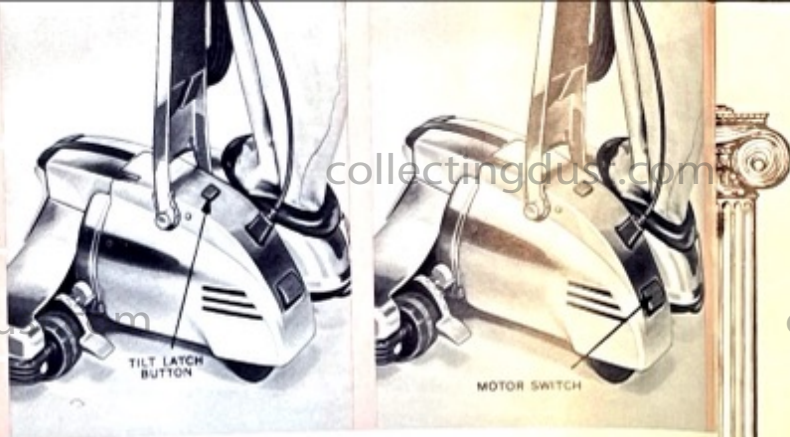

### TILT LATCH

This latch permits the long handle to swing in an arc to a point where additional downward pressure raises the rug nozzle up and over the edge of rugs, electric cords, and other obstructions. This action is accomplished by sliding the tilt latch button toward the toe touch control side of the Kirby as far as it will go.

When it is necessary to operate the Kirby under low furniture, the handle can be brought to a horizontal position simply by sliding the tilt latch button to the extreme opposite position — toward the bag and Sani Em-Tor.

### HANDLE LOCK

To lock the handle in the horizontal position for the cleaning of stair treads, or for storage in small areas, simply push the tilt latch button toward the toe touch control side of the Kirby while the handle is in the horizontal position. It may be necessary to maintain pressure on the button as you gradually raise the handle.

### MOTOR SWITCH

The Kirby motor is turned on or off by depressing the large push button switch located just above the rear wheels with either your toe or hand.

## how to use the SANI EM-TOR



The Sani Em-Tor, and the patented Sani-Pocket, is found only on the Kirby. They enable you to empty the bag right in your home without muss, fuss, or expense. Because your Kirby picks up more dirt, the Sani Em-Tor should be emptied after each thorough cleaning. If dirt is allowed to accumulate in the filter bag, the cleaning efficiency of your Kirby will be reduced.

### EMPTYING THE FILTER BAG

1. Detach bag chain from handle clip.
2. Lower rug nozzle to No. 0 position (see page 9) and turn on motor.
3. Allow motor to run briefly, and then turn off. While bag is still extended, shake it vigorously from the top.
4. Spread newspaper on the floor and place Kirby on it.
5. Tilt Kirby slightly and rotate side lever fully to release cover.
6. Swing cover out from under Sani Em-Tor and turn it upside down, emptying the dirt and lint onto the paper.
7. After all dirt has been removed, swing cover back into place and lock securely with locking lever.

*(If excessive dirt and lint has accumulated in the bag, and does not fall readily into the Sani Em-Tor, use the following procedure.)*

1. Open zipper at rear of bag and place hand into patented Sani-Pocket, grasping Sani-Scraper at bottom.
2. Scrape sides of bag with Sani-Scraper in downward strokes.
3. Using Sani-Scraper, push excess lint and dirt into Sani Em-Tor.
4. Empty as in "5" through "7" above.



## attachment instructions on HANDI- BUTLER

On the front of your Handi Butler you will find a lever which can be rotated between "ON" and "OFF" positions. This is the belt lifter for the Handi Butler.

**STEP 1.** Set the lever in the "ON" position and by looking through the round opening at the back, make sure the belt is over the metal finger. If it is not in place, use a lever such as a screwdriver to slip the belt over the finger.

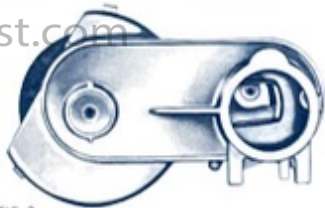
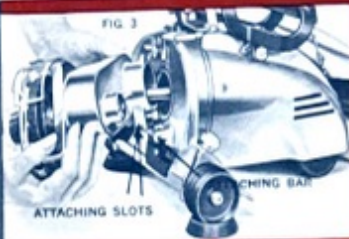

FIG 2

**STEP 2:** Turn the belt lifter lever to the "OFF" position thus extending the belt (figure 2). The unit is now ready for attachment to the motor unit.

**STEP 3.** Raise the floodlight hood. Hold the Handi-Butler so the attaching slot is on the attaching bar which is just below the belt drive shaft or motor pulley. (Figure 3). The belt drive shaft should enter



ATTACHING SLOTS

the large round opening and pass through the loop formed by the belt.

**STEP 4:** Swing the unit back against the Kirby; and at the same time, press the attaching slots of the Handi-Butler on the attaching bar of the Kirby. While holding the unit in place, turn the attachment lock lever to hold the unit firmly (figure 4).



FIG 4

**STEP 5:** Turn the belt lifter lever to the "ON" position and the unit is ready for operation. Rubber cups, which are provided, should be placed under the front wheels to steady the unit (figure 3). When using the grinding wheel, look through the eye shield part of the transparent grinding wheel cover to help protect your eyes. Safety glasses are recommended when using the wire brush or grinding wheel.

## how to use your SWEDISH MASSAGE UNIT

The Kirby Swedish Massage unit puts magic in your fingertips. It provides the controlled, rotating, patting movements which enable you to give a gentle, pleasant, and soothing Swedish type massage.

To use the Massage Unit, simply remove the chuck from the Flexible Shaft, and turn on the metal eccentric weight part included in the Handi-Butler box. Snap the plastic cover over the eccentric weight by pressing the open end on to the Flexible Shaft handle. Your Massage Unit is now ready for use.

Hold the Flexible Shaft handle in the normal position in your right or left hand with the thumb and forefingers next to the large end of the handle. Curl the thumb around the handle, but leave the fingers free to contact the surface to be massaged.

When you turn on the Kirby motor unit, you'll feel a vigorous, but gentle vibration through your fingers. As with all massage units, the vibration is to be transmitted only through the fingers. Using it in this manner, you control the action to a pleasant and soothing degree. Take your time. Do not dig in with the fingers.

You'll find the Kirby Massage Unit much easier to use than other devices, since it is not necessary to support the weight of the motor when using it.

Massage can be applied in a wide variety of ways, some of which are as follows:



### GENERAL MASSAGE

Use for neck, chest, abdomen, and back.

### SCALP MASSAGE

Apply to all areas of the scalp by supporting the head against the pressure of the massage with the free hand. Especially soothing in the back of the neck as you begin to doze.

### FacIAL MASSAGE

Apply after cold cream, using the fingers of the free hand to steady the skin but as necessary. Avoid contact with sensitive areas, such as around the eyes.

### FOOT MASSAGE

Use at heel, bottom of foot, and toes for complete relief. You will find stroking, kneading, rotating, and patting movements to relax tired muscles.

### CAUTION:

Do not use massage on any areas that are swollen, inflamed, painful, covered with skin eruptions, or where the case veins, unless you consult your physician first.



## how to use the HANDI-BUTLER

### THE ASSEMBLY OF WORK WHEELS

The grinding wheel, wire brush, and buffing wheels may be attached to either the Handi-Butler itself, or the flexible shaft. The sanding disk and lambswool pad will attach to the flexible shaft only. To attach to the Handi-Butler, grasp the wheel by the finger grip and insert the wheel shaft into the drive shaft opening. The magnetic clutch will hold the wheel firmly in place. To remove, grasp the wheel by the finger grip and pull firmly away from the drive shaft. To attach to the flexible shaft, insert the wheel shaft into the drill chuck and tighten. It is not necessary to use pliers or a wrench when tightening or loosening the chuck. Simply press the small shaft locking button into one of the slots in the flexible shaft handle face plate. This holds the shaft, while tightening or loosening the chuck, as a wrench would. The drawings on the right show typical assemblies, and in the case of the work wheels, the same sequence is followed with each.

### ATTACHMENT OF FLEXIBLE SHAFT

To attach the flexible shaft, grasp the knurled collar of the bayonet connection and insert the core wire into the small hole at the rear of the Handi-Butler housing. Align the slots in the collar with the pins on the housing and with a firm forward pressure, twist to the right. When released the connection will lock firmly in place.

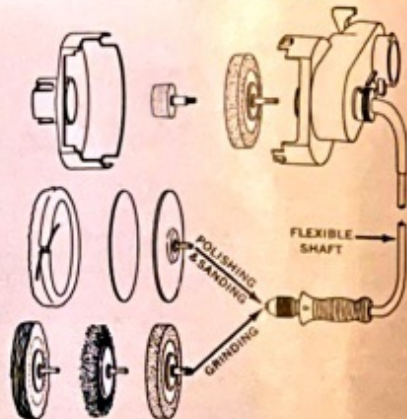

A slight rotation of the Handi-Butler drive shaft may be needed to permit the core wire to engage with the drive shaft. Caution should be taken to be sure the hand grip of the shaft is held in the hand whenever the power is on.

### WHEEL GUARD COVER

The wheel guard cover attaches to the Handi-Butler by sliding the open edge into the spring clips on the Handi-Butler. An eye shield portion of this transparent part extends downward around the wheel opening to protect against injury from small particles thrown off the wheel when grinding or wire brushing.

## how to use the HANDI-SHARPENER

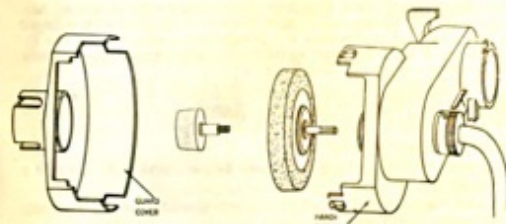

### POLISHING AND BUFFING

The lambswool polishing pad is stretched over the rubber disk and fastened by drawing the strings tight and tying. Be sure to tuck the loose ends under the edge of the pad. This pad is ideal for polishing waxed surfaces such as your table tops, shoes, and automobile.

Your buffing wheels can help you restore the luster to your silverware or other decorative metal objects around your home. The sheeting buffing wheel is used with the red polishing compound No. 1 to polish brass, copper, or similar metals. The flannel buffing wheel is used with the light-colored polishing compound No. 2 to polish precious metals such as gold or silver. The polishing compounds are applied by holding the stick against the rotating wheel.

### HANDI-SHARPENER

Your Handi-Sharpener is assembled and ready to use when you receive it. If it becomes necessary to replace the knife sharpening wheel, simply unscrew it from the grinding wheel. Replacement wheels can be obtained from your Kirby dealer.

The preferred method of sharpening a knife is as follows: Remove the plastic wheel guard, rotate 180° and replace. The rim of the plastic wheel guard will cover the large grinding wheel and eliminate the possibility of accidental contact. Hold the knife to be sharpened in your right hand, using the left hand to assist in steadying the knife handle. Insert the knife blade at the handle end into the top slot and guide it back and forth, keeping the edge of the blade against the grinding wheel. Now sharpen the other side of the knife by inserting the blade into the bottom slot and repeating the operation.

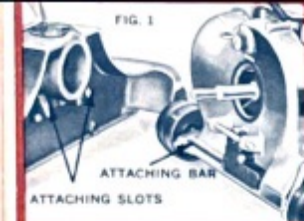

## ASSEMBLY INSTRUCTIONS

### HANDLE ASSEMBLY SWIVEL CORD HOOK WRENCH

The long handle is in two pieces in the shipping box, and is usually assembled by your Kirby dealer at the time of purchase. Should you ever want to re-pack the cleaner in the box, disassemble the handle as follows:

Remove the handle from the Kirby by pulling out the handle fork pin, and remove the cord. Grasp the top swivel cord hook in one hand and the handle in the other. Pull the cord hook away from the handle (against the spring.) You will feel the notches in the cord hook hole engage the head of the attaching screw, like a wrench. Using the cord hook like a wrench, turn it counter clockwise about three turns, or if you wish, you may use a Phillips screwdriver in the "cross" slot provided in the attaching screw head. When you have done this, press down on the screw head with one hand and pull out the handle grip with the other. For re-assembly, simply push the grip part into the metal part until you hear the "snap," then tighten the screw firmly.

### UPRIGHT CLEANER

The following units should be attached to the Motor Unit for use as an upright rug cleaner: Rug Nozzle, Long Handle, Sani Em-Tor and Bag.

#### ATTACHMENT OF RUG NOZZLE

**STEP 1:** Prepare Rug Nozzle for attachment by raising belt on belt lifter finger. This is the "Belt is Off" position.

**STEP 2:** Set Toe-Touch Nozzle Adjustment at No. 7 position on adjustment scale. (See instructions on page 9.) Raise floodlight hood.

**STEP 3:** Place attaching slots at back of Rug Nozzle on the attaching bar. (See figures 1 and 2.) Swing nozzle back toward motor unit with a slight downward pressure so as to depress the safety switch slide (see figure 2). Hold nozzle in place with one hand and lock in place with attachment lock lever at top-front of motor unit. (See figure 3.)

**STEP 4:** Turn belt lifter on "ON" position (figure 4). To remove nozzle, reverse these steps. Be sure to have belt lifter in "OFF" position before releasing attachment lock lever. (See figure 3.)

#### ATTACHMENT OF LONG HANDLE

**STEP 1:** Remove handle pin from motor unit by pulling straight out with a slight twisting action.

**STEP 2:** Insert the fork of the long handle into the slide at top of motor unit, (see figure 5).

**STEP 3:** Replace handle pin as far as it will go.

#### ATTACHMENT OF SANI EM-TOR

**STEP 1:** On the inside of the Sani Em-Tor collar you will notice three curved slots. These should be lined up with the pins on the neck of the motor unit.

**STEP 2:** Slide the collar firmly over the neck and twist downward. The unit will lock firmly in place. (See figure 6.)

When the unit is new, the rubber gasket inside the collar of the Sani Em-Tor will be stiff and offer some resistance. This gasket is necessary to give you an air-tight seal.

To remove the Sani Em-Tor simply twist from the bottom and away from the motor unit. It will unlock with a snap.

#### ATTACHMENT OF FILTER BAG AND CORD

Plug the cord into the rear of the motor unit just above the switch button. Fasten the cord hook to the clip just below the handle grip and wind down under the lower cord hook up over the swiveled cord hook. (Figure 7). Fasten the bag chain to the other side of the double clip.

#### SUCTION RELIEF VENT

Turn vent plate clockwise to open. When open, it is easier to clean efficiently long pile cotton or synthetic carpets and light weight throw rugs. Vent should be closed for normal, full power cleaning operations and when emptying bag. See page 6 for location.



## how to use the DUSTER-BUFFER

With the Kirby assembled as an upright rug cleaner, snap the floor duster pad into place by inserting the spring clips into the rug guard on the bottom of the rug nozzle. Adjust the toe touch nozzle adjustment until the floor duster pad is just touching the floor. Turn the Belt Lifter to disengage brush, turn on the motor, and you are ready to buff dust hard surfaced floors.



## how to use the MIRACLE HEAD® & RUG FLUFFER

Assemble the Kirby as an upright cleaner. (see pages 16 and 17) with the exception of the rug nozzle. In its place, attach the Miracle Head® nozzle. Attachment procedure is the same as for the rug nozzle. (See page 16.)

Apply wax to the surface to be protected. Polishing can be done immediately after applying Kirby Wax — no drying time is required for Kirby Wax — as other waxes may require. Set the toe touch nozzle adjustment to the lowest or "0" position, (see page 9) so the front wheels do not touch the floor. Set handle in normal cleaning position. Turn on the motor and the polisher brush will quickly polish your waxed floor to the highest possible luster. The best polishing results will be obtained when the polisher is resting only on the rear wheels and the polisher brush.

By pushing the handle down against the tilt latch (see page 10) it is possible to raise the brush and easily polish a six inch baseboard.

When storing the Miracle Head® nozzle, be sure to turn the belt lifter to the "ON" position. If you don't, the belt will become stretched and lifeless, resulting in slippage.



## how to use the RUG RENOVATOR

Before shampooing rugs or carpeting with the Rug Renovator, the entire area to be renovated must be thoroughly vacuumed using the Kirby Upright.

### ATTACHING RENOVATOR TRAY

Remove the rug nozzle, Sani Em-Tor, and bag from the Kirby. The renovator tray attaches to the nozzle assembly (figure 1) by sliding the renovator tray into the slots at each end of the nozzle assembly. Turn the belt lifter to "off" position and attach the renovator nozzle to the front of the Kirby motor unit the same way you attached the rug nozzle. (See Upright assembly instructions page 16.)

Attach the renovator tank to the neck of the Kirby, as you did the Sani Em-Tor, making sure the sponge-like filter is in place. (See attachment of Sani Em-Tor page 17.)

Insert end of hose with angle fitting, into hole in the center of the renovator tray. Slip other end of the hose over the tank discharge.

Fill the tank with warm water to "fill line" (1 quart) and add 2 oz. of Kirby Instant Suds, using the tank cap as a measure. One tankful of solution should be sufficient to clean an area approximately 9 x 12 ft.

### ADJUSTING RENOVATOR

To adjust the rug renovator to the proper height for shampooing your rug or carpeting, depress the toe touch control as far as it will go. This raises the lever to the maximum height and the pointer will indicate No. 7 on the adjustment scale. Lower the rug renovator a step at a time by depressing the toe touch control. Check for proper height by moving unit back and forth at each level of adjustment. Lower until brush leaves a slight drag on carpet or rug. You are now ready to begin the shampooing operation.

### DEPOSITING SUDS

Start the Kirby motor. Shampoo suds will start to flow down the transparent hose through renovator tray to the rug. Push and pull the unit slowly back and forth with overlapping strokes. A layer of suds the entire width of the tray will be seen on the back stroke of the rug renovator if the height is properly adjusted. If suds accumulate in front of tray, move the unit faster; if width of suds left on rug is not as wide as the tray, move unit slower. The dirt and spent suds will be deposited in the tray, the rug surface will be slightly damp after shampooing, and some residual light suds may remain. Rug protector pads furnished must be placed under all legs of furniture to protect against rust stains. When the surface has become dry, the residue will turn to a dry powder, which can be easily removed and the nap of the rug restored by a thorough vacuuming with the Kirby with rug nozzle attached.

### CLEANING RUG RENOVATOR

It is important for good operation that the rug renovator be cleaned after each use.

Remove the hose from the tank. Remove the tank from the neck of the Kirby motor unit, then remove the air filter and slip the Suds-O-Screen off of the tank. Rinse the sponge filter and Suds-O-Screen under running water. Remove the tray and nozzle assembly from the motor unit. Release the belt from the belt lifter and remove the renovator nozzle from the tray. Rinse the tray under a water faucet to remove the dirty suds and lint, being careful not to saturate the brush. Open the hinged shelf and remove the dirt and lint. Shake any excessive water from the brush before re-using or storing the unit.

When storing the rug renovator, be sure the belt is not left up on the belt lifter hook. Leaving the belt on the belt lifter hook will cause the belt to stretch and result in slippage.



## how to use the **BASIC** attachments

The Kirby hose furnished with your standard set of attachments is designed for direct connection to either the "intake" or "blower" side of the Kirby motor unit, by means of the universal coupler attached to the hose.



### THE PORTABLE HANDLE AND SHOULDER STRAP

Remove handle pin and long handle. Slide legs of portable handle into place on top of the motor unit as illustrated. Replace handle pin. The shoulder strap is hooked to the loops provided at top and rear of handle.



### ATTACHING HOSE TO "INTAKE"

Hook the attaching slots of the hose coupler over the attaching bar at the front of the motor unit. Swing the hose coupler back against the motor unit and lock in place with the attachment lock lever.



### ATTACHING HOSE TO "BLOWER OUTLET"

Place hose coupler over the neck or blower end of the motor unit and push it into place with a clockwise twist. It will lock into position. When using the Kirby in this fashion, it is necessary to attach the Crystalator to the front (intake) of the Kirby motor unit to depress the speed control switch. (Instructions on page 24.)



### BAG ATTACHMENT FOR PORTABLE UNITS

Sani Em-Tor and bag are attached as explained on page 17. Bag is then folded under and bag chain hooked to the clip at the back of portable handle.



## how to use the **SPRAY-GUN** **SUDS-O-GUN**

### THE SPRAY GUN

Assemble the floor portable or shoulder portable unit as instructed on pages 22 and 23, except that the flexible hose is connected to the blower outlet or neck of the motor unit in place of the Sani Em-Tor. The Spray Gun is attached to the hose with a firm twist.

Paints should be thinned for spray application as instructed on the can. To fill the Spray Gun jar, unscrew from unit and fill about three-fourths full. Avoid overfilling to prevent spillage in use. An extension tube is provided inside the supply tube which can be extended for larger jars. Screw jar back in place firmly.

Turn on motor and adjust to proper spray. Turning the button at the rear of the gun clockwise makes the spray finer. Pull trigger with index finger to spray.

The gun may be quickly cleaned after use by spraying a solvent or paint thinner through the gun using a clean jar. If necessary the entire assembly may be taken apart by removing the valve stem from the valve seat and immersing these parts in solvent. Spray gun parts are not harmed by ordinary solvents or thinners.

### THE SUDS-O-GUN

Assemble Spray Gun as explained above, and place Suds-O-Gun cap over the front of spray gun — a clockwise twist will do it.

Mix Kirby Instant Suds as directed on bottle, and fill jar about three-fourths full. Adjust gun to a very fine spray. A volume of very dry suds will then be produced. Suds can be spread directly on surface to be cleaned or gathered in a basin.

The suds should be worked into the surface with a brush or sponge until they disappear. Allow a few minutes for surface to dry thoroughly and vacuum with appropriate nozzle to remove the dry froth which now contains the grime and dirt.



how to use the

## PORTABLE UNITS

### HAND PORTABLE

This is a powerful unit which will do a magnificent job of cleaning your deep cushions and stair treads. It is especially suited for use on your mattress.

To assemble, attach the following to the motor unit: Rug nozzle, (see page 16). The portable handle (page 20). The Sani Em Tor (page 17). Hook the bag chain to the clip on the portable handle and with the toe touch nozzle adjustment (page 9) set the nozzle height at the position most suitable.

### SHOULDER PORTABLE

This unit is ideal for cleaning large areas where considerable mobility and freedom of hands are advantages. It is also convenient to use with the Handi Butler and flexible shaft. Assemble the following to the motor unit: flexible shaft (see page 20 or 12, 13, and 14). Sani Em Tor and filter bag (page 17.) and the portable handle and shoulder strap (page 20).



### FLOOR PORTABLE OR TANK TYPE CLEANER WITH SURFACE NOZZLE

This is a unit which gives you the light-weight portability of a tank type cleaner for above-the-floor cleaning operations around your home. Used with various combinations of the tools and extension tubes, you can clean those hard-to-reach areas in your home with ease. To assemble, the following should be attached to the motor unit: Sani Em-Tor and bag, suction coupler, flexible hose, and appropriate extension tubes and tools. For complete portability, remove the long handle and replace it with the portable handle.

Extension tubes and tools are connected simply by inserting the tapered end of the hose or tube into the tool with a firm twist. To release simply twist and pull.

### THE SURFACE NOZZLE

This nozzle has been designed to facilitate the surface cleaning of carpets and hard surfaced floors under your low furniture, and for dusting of all hard surfaced floors.

For cleaning carpets, flip brush adjustment lever on front of nozzle to left, so word "UP" appears on lever. This raises the brush to the proper height for carpets. For cleaning hard surfaced floors, flip the lever so word "DOWN" appears on the lever, thus adjusting the brush to the proper height for bare floors. The following is a listing of recommended lever settings for the various types of cleaning you may encounter with your Kirby surface nozzle.

#### UP

Bare floors — dust only  
Deep pile rugs  
Cotton loop rugs

#### DOWN

Bare floors — imbedded dirt  
Bare floors — lint and fuzz  
Short pile rugs

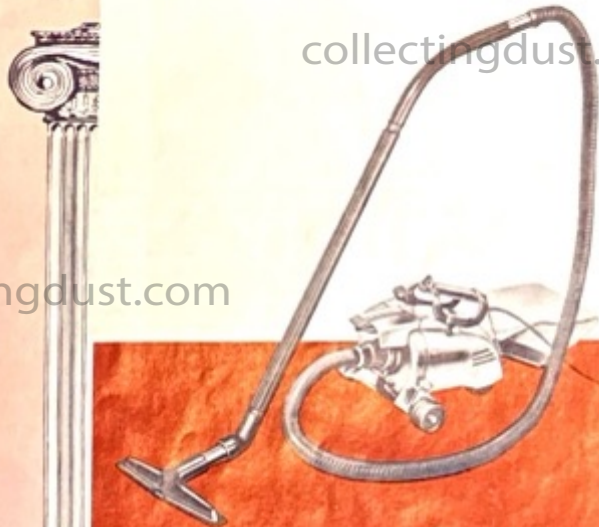

## how to use the CRYSTALATOR

**FILLING THE CRYSTALATOR** Pull the cap off the body of the Crystalator. Pour in Paradichlorobenzene Crystals (moth crystals) until Crystalator is about half full when held in a horizontal position. A finger inserted into the inner cone will close the slot and prevent spillage. Replace cap and turn to desired setting "GAS" for de-mothing a closet or other confined area; "MEDIUM CRYSTALS" for furniture, baseboards, carpets, etc.; "FULL CRYSTALS" when it is desirable to deposit large crystals in chests or storage boxes. Check the position of the air vent slide cover on top of the Crystalator barrel. With the vent slide cover in the closed position, the unit is now ready for operation.

**ATTACHING THE CRYSTALATOR** Place the attaching slots of the Crystalator over the attaching bar at the front of the motor unit. Swing the Crystalator back against the motor unit and lock in place with the attachment lock lever. To do this, a slight downward pressure should be applied so as to depress the speed selector switch.

**NOTE:** The air vent slide cover on top of the barrel of the Crystalator should always be left in the open position to allow maximum air passage, except when using the de-mothing system. Then it must be closed.



**USE WITH HOSE** Assemble the Crystalator Unit as described on the preceding page and also attach the hose and the crevice tool to the blower outlet. See illustration at the right. The crevice tool brush may be removed by squeezing the wire together at the point where it enters the tool and pulling straight out.

**DE-MOTHING A CLOSET** Assemble the Crystalator Unit as described above, and without attaching the hose, place the unit on the floor of your closet. Turn the Crystalator cap to the "GAS" position, turn on the motor, and close the door. It is advisable to seal the crack at the floor with a throw rug. Allow the motor to run for from 5 to 15 minutes, depending on the size of the closet.

If crystals cling together, they tend to stop the action of the Crystalator. If this happens, just place your hand over the holes in the top of the Crystalator body for a second while the motor is running. This will loosen the crystals and start them flowing into the fan chamber where they are exploded into a moth-killing gas.

### CAUTION:

Follow directions and cautions on label of crystal container. Keep crystals out of reach of children. Crystals may be harmful if taken internally. Do not breathe the concentrated gas from the Crystalator. Do not enter a treated closet until it has been ventilated. Do not remain in a treated room until gas concentration is reduced to safe level. If eye, throat, or skin irritation occurs, do not remain in treated area. Return unused crystals to closed container and seal tight. In the crystalator, use only 100% pure paradichlorobenzene with U.S.D.A. registration number in the Crystalator.



# ROLL-O-WAXER

## HOW TO LOAD IT

1. Unscrew the roller head from the pressure cylinder by holding the roller head, in plastic covers, with your left hand and turning the pressure cylinder counterclockwise with your right hand. Grasp pressure cylinder in label area.
2. Insert a Kirby Roll-O-Wax container into the pressure cylinder with the lettered face against the black rubber piston. Clip the "RED" end of the protruding "Nipple." Insert the opened "Nipple" of the Roll-O-Waxer container into the hole leading to the roller axle.
3. Re-assemble the roller head to the pressure cylinder by turning clockwise.

## HOW TO USE IT

1. Remove the protective plastic covers from the roller head with a slight twist and pull.
2. Roll the roller head over the floor as you would a paint roller. Make overlapping strokes of about three feet in length. Use gentle pressure and let the Roll-O-Waxer do the work.
3. To start or increase the feeding of wax to the roller head, rotate the Magic Wand handle clockwise. Each time you rotate the handle one turn you will feel and/or hear a "click." One "click" is usually required for each nine square feet of floor. Do a section at a time, so that you will not have to walk on a waxed area when polishing. A thin coat of wax evenly applied is most desirable. Do not be concerned if streaks appear when applying wax because the buff-

ing action of the Miracle Head® will spread the wax evenly.

4. Under normal conditions no drying time is required for Kirby Wax. Polishing with your Kirby Miracle Head® can be done immediately. Polishing in two directions — longwise and across wise — will enhance and give added lustre to the floor.
5. Always replace the Roll-O-Waxer protective plastic covers and lock them together after each use, so that the wax in the roller head will remain fresh.
6. When red signal can be seen through the reload signal opening in the handle, or when you are unable to turn the handle, the wax in the pressure cylinder has been used up and the pressure cylinder must be reloaded.

## HOW TO RELOAD IT

1. Unscrew the roller head from the pressure cylinder as per instructions in No. 1 of "How to Load It."
2. Remove the spent wax bag and turn back the black rubber piston by holding the pressure cylinder in label area, and turning the handle counterclockwise.
3. Proceed then as per instructions in No. 2 on "How to Load It."

AVOID STORING THE ROLL-O-WAXER IN A HOT, DRY PLACE.

USE YOUR ROLL-O-WAXER FREQUENTLY — EVERY WEEK OR TWO THE MORE IT IS USED, THE BETTER IT OPERATES.

KEEP ROLL-O-WAXER CHARGED WITH WAX.

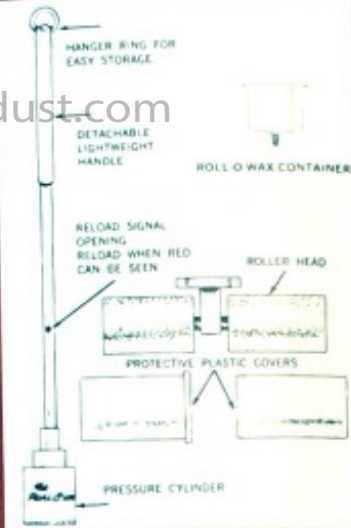

**IMPORTANT:** Be sure to use only the special Kirby Roll-O-Waxer bags of Bri-Nax Carnauba Tree Wax, Kirby Handi-Wax or other makes of paste wax should not be used, since these waxes will not flow freely through the roller head. If any wax other than the special Kirby Roll-O-Waxer wax is used, it will require complete disassembly and thorough cleaning to recondition the Roll-O-Waxer, and the usual guarantee will be null and void.

## HELPFUL HOME SERVICE HINTS

If Kirby will not pick up lint or ravelings on carpet, check to see if:

1. Belt Lifter is in "OFF" position (Page 8).
2. Belt is broken or worn out (Page 29).
3. Brush needs adjustment (Page 28).
4. Toe Touch Nozzle Adjustment is improperly adjusted (Page 9).
5. Filter bag needs emptying (Page 11).
6. Brush needs cleaning (Page 28).

If motor will not run but floodlight lights up

1. Make sure the rug nozzle, Crystalator, Handi-Butler, Miracle Head® or hose is properly in place on the front of the motor unit.

If motor will not run and light does not light

1. Check to make sure cord is properly plugged into the Kirby and wall outlet.
2. Make sure there are no breaks in cord. Check by attaching to a floor lamp and flexing back and forth along entire length of cord. Pay particular attention to male and female connectors at ends of cord.

If rug nozzle is loose even after proper attachment:

1. Attachment lock not turned tight enough.

If Sani Em-Tor is loose:

1. Check to be sure it is locked in position by turning clockwise as far as possible, (see Page 17).

2. Check to see if rubber gasket inside collar of Sani Em-Tor is properly in place.

If Miracle Head® brush will not revolve:

1. Make sure belt lifter is in "ON" position.
2. Check condition of belt — replace if necessary. (See page 29).
3. Make sure belt is not wet with wax.

If Handi-Butler work wheels will not revolve or stop under light pressure:

1. Make sure belt lifter is in "ON" position.
2. Check belt and replace if broken, worn, or stretched. (See page 29).

If motor runs but light does not light:

1. Check bulb for tight fit.
2. Bulb burned out — replacement needed.

If dirt will not fall out of bag and Sani Em-Tor

1. Too much dirt has been allowed to accumulate and it is jamming the large opening of the Sani Em-Tor where the bag is attached. Use Sani-Scraper in Sani-Pocket to clean bag and force dirt into Sani Em-Tor.

If Kirby is hard to push when rug nozzle is attached:

1. Toe Touch Nozzle Adjustment set too low. Raise one or two notches. (Page 9).

## BRUSH ADJUSTMENT AND CLEANING

Through usage, the revolving brush in the rug nozzle will gradually wear down. When it fails to protrude approximately 1/16 inch beyond the stainless steel rug guard — check by laying a flat piece of stiff cardboard across a portion of the rug guard — turn the brush roll adjustment screws at each end of the brush roll clockwise with a screwdriver until the proper amount of bristle protrudes. Be sure to turn each screw an equal amount so the same amount of bristle protrudes on each end of the brush roll.

### TO REMOVE BRUSH ROLL FROM RUG NOZZLE

1. Remove nozzle from motor unit.
2. Turn belt lifter to "ON" position.
3. Swing rug guard from nozzle on hinges as pictured.
4. Spread support brackets by bending slightly away from brush roll. The brush may then be removed for cleaning.
5. Use scissors to cut string, thread, or hair which may be wrapped around the brush roll. An old comb is also useful in removing foreign matter embedded in brush tufts.

### REPLACEMENT OF BRUSH ROLL

1. Place ends of brush roll into support brackets — one end is wider than the other so it can be replaced only the correct way.
2. Bend the support brackets back into place.
3. Make sure belt is positioned in center of brush roll.
4. Swing rug guard back into the nozzle — it will snap into place. Make sure belt is not pinched.



## BELT REPLACEMENT

**RUG RENOVATOR** - Remove the renovator nozzle assembly and the tray assembly from the motor unit. Release the belt from the belt lifter and remove the renovator tray from the nozzle assembly. Remove the screw and plastic bumper from both sides of the tray using a Phillips screwdriver. The brush is now free of the tray and a new belt will slide over the brush roll. Replace the brush in the tray and line up the axle with the screw holes. Replace bumpers and tighten screws securely.

**GENERAL INSTRUCTIONS** A belt in good condition is essential for the efficient operation of the Kirby rug nozzle, Miracle Head®, Handi-Butler, and Rug Renovator. If any of these units fail to perform properly, the belt should be examined and replaced if it has become worn, stretched, or broken.

The Kirby belt transmits the power from the motor to the brush roll of the rug nozzle and the Miracle Head®, Rug Renovator, and to the work wheels on the Handi-Butler. Therefore, a belt in good condition is essential for the efficient operation of these units.

**RUG NOZZLE** If the rug nozzle fails to remove lint from the surface of the carpet, the cause of the difficulty may be a weak or broken belt.

To replace the rug nozzle belt, remove the nozzle from the motor unit and remove the



brush roll from the rug guard as explained under brush cleaning on page 28. The worn belt will slide over the end of the brush roll and can be replaced with a new one.

### HANDI-BUTLER

1. Remove Handi-Butler from motor unit.
2. Remove work wheels.
3. Turn belt lifter to "ON" position.
4. With screwdriver slide belt off belt lifter finger.
5. Remove belt by sliding it out over drive shaft to which work wheels are attached.
6. Install new belt by reversing above steps.

**MIRACLE HEAD®** Remove the Miracle Head® from motor unit and turn belt lifter to "ON" position. Loosen the screw at one end of the nozzle about a half turn with a Phillips screwdriver. Remove the screw and rubber bumper from the other end. Swing the brush roll out slightly being careful not to bend axle or remaining screw. Slide worn belt off open end. Replace with a new one. Swing brush back into nozzle, line up axle with screw hole and replace screw and bumper. Tighten both screws.





## BULBS • CORD • FILTER BAG • LUBRICATION

Your Kirby motor has been properly lubricated at the factory and should not need additional lubrication for several years. Lubrication should be done only by an authorized Kirby Serviceman. All other bearings are permanently lubricated and will need additional lubrication only after extreme use.



### CORD SERVICE

The Kirby cord can be easily removed from the Kirby for use as an emergency extension cord. With reasonable care it will last for years.



### FILTER BAG MAINTENANCE

Keep the plastic bag guard in place around the point where the bag is fastened to the Sani Em-Tor. This will minimize wear, and under average use, your bag will last for many years. The only time it will need replacement will be at times of general overhaul. The bag is fastened to the Sani Em-Tor with a strong spring, and reasonable strength and skill is required for its replacement.



### BULB REPLACEMENT

Lift floodlight cover and remove the old bulb by depressing and turning bulb counterclockwise. It is a bayonet-type base and replacement is made by sliding small lugs on base of bulb down into slots in socket with a firm downward pressure and a clockwise twist. The bulb will lock into place.



## KIRBY WAX WITH KGF-40

Kirby Emulsion type paste wax is especially designed for ideal use with the Kirby Miracle Head®. This completely new concept in floor wax gives you all the qualities of a hard, long lasting, slip resistant wax plus a proven germ fighting additive that cannot be incorporated in any mineral spirit, kerosene, or turpentine type of wax. This wax can be polished immediately after application — safe to use on any type of linoleum, asphalt tile, vinyl tile, rubber tile, cork tile, or wood floor.

Refill packages containing two half pound pouches are obtainable from your Kirby dealer.

## KIRBY HANDI-WAXER

The Kirby Handi-Waxer is designed to fit your Kirby extension tubes, and provides a wide swath applicator in a convenient size package. A plastic cover of inert and flexible material helps to keep the wax from drying out when not in use. Each waxer contains a half pound package of Kirby Emulsion Wax. To use the waxer, slit the wax pouch with a sharp knife through the slot in the felt bottom face. The wax will feed into the felt when pressure is applied on the extension tube. Convenient step pads are provided on the waxer to enable you to increase the pressure on the wax if normal applying pressure from the extension tubes is not sufficient.



## KIRBY INSTANT SUDS WITH KGF-40

Now you can clean carpets, upholstered furniture, and other household articles with volumes of extra dry suds and help to make them safe against air and dust born bacteria. For cleaning carpets and rugs, set up the Kirby for Rug Renovator operation, fill tank with warm water to "fill line" (one quart) and add two ounces Kirby Instant Suds using the Renovator tank cap as measure. For cleaning upholstered furniture and other household articles, set up the Kirby for spray gun operation and mix three bottle caps full of Kirby Instant Suds with 3/4 jar full of lukewarm water. Attach the Suds-O-Gun screen to the front of the spray gun. Use a fine setting of the adjustment screw, you can make a tremendous volume of suds from a small amount of liquid. Direct the suds into a bowl, or over a small area of the surface to be cleaned, and brush suds into the surface until the suds disappear. After drying, remove the residue (which now contains the dirt) by vacuuming with your Kirby. Kirby Instant Suds come in an unbreakable 12-ounce plastic bottle, and full directions are included on the label. This combination of cleaning power, resoling resistance, mildew prevention, fabric brightener, and germ fighting action makes Kirby Instant Suds with KGF-40 unique.



## KGF-40 CONCENTRATE WITH DEODORANT

Here at last is a means of fighting infectious air borne bacteria in your home. Kirby KGF-40 concentrate enables you to do this simply and effectively. Set up your Kirby for spray gun operation. Mix three bottle caps full KGF-40 concentrate into 3/4 of a spray gun jar full water. Remove Suds-O-Gun nozzle. Adjust the valve opening on the spray gun by means of the adjustment screw located in the rear of the handle so that a fine mist is obtained. Lightly spray floors, rugs, or other surfaces upon which dust or air borne bacteria may settle. KGF-40 may also be effectively applied to your Kirby filter bag, furnace or air conditioning filter. KGF-40 concentrate is available in a 12-ounce unbreakable plastic bottle from your Kirby dealer, and will mix nearly two gallons of effective spray. Rinse the spray gun and jar with clean water after use. Will not harm surface not harmed by water alone.

## ● KIRBY GENERAL COVERAGE WARRANTY

This Kirby General Coverage Warranty, which includes the Kirby Warranty, General Service Insurance and Coverage of Loss by Fire, is null and void if the name plate or serial number of the Kirby described herein has been defaced, removed or changed. The following provisions state the exclusive remedies for any breach of warranty or any other claim in respect of the Kirby product described herein. Without limiting the generality of the preceding sentence, it is expressly agreed that The Scott & Fetzer Company, manufacturer of the Kirby product described herein, shall not be liable for any consequential damages for injury to property resulting from the use of such product. **THERE ARE NO WARRANTIES WHICH EXTEND BEYOND THE DESCRIPTION ON THE FACE HEREOF, AND THIS GENERAL COVERAGE WARRANTY IS EXPRESSLY IN LIEU OF ALL OTHER WARRANTIES, EXPRESS OR IMPLIED, OF MERCHANTABILITY OR OTHERWISE, AND OF ALL OTHER OBLIGATIONS OR LIABILITIES ON ITS PART.** The Company neither assumes, nor authorizes any other person to assume for it, any additional liability in connection with the sale of its products.

### WARRANTY

Subject to the conditions and exceptions stated in this Kirby General Coverage Warranty, The Kirby Co., Division of The Scott & Fetzer Company, herein called the "Company," warrants the Kirby product to be free from defects in material and workmanship under normal use and service. At any time within one year from the date of delivery to the original purchaser, the Company will furnish for the Kirby product, a replacement part for any part returned to and found by the Company to be defective. Such replacement part will be furnished without cost to the owner (except transportation charges) through an authorized Kirby Service center or f.o.b. its factory at the Company's election. This Warranty does not apply to belts or to light bulbs, or to damage caused by accident, misuse, negligence, abuse, or to any Kirby products which have been repaired by other than a Kirby authorized service center so as in the judgment of the Company to affect its stability or reliability, or in which parts not made by, sold by, or approved by The Kirby Company Division shall have been used.

GENERAL SERVICE INSURANCE AND COVERAGE OF LOSS BY FIRE VOID UNLESS THE SERIAL NO., THE DATE OF DELIVERY, AND AUTHORIZED SIGNATURE APPEAR ON PAGE 33 OF THIS BOOK.

### GENERAL SERVICE INSURANCE

Subject to the conditions and exceptions stated in this Kirby General Coverage Warranty, and on further condition that the Kirby has been originally purchased from an authorized Kirby Distributor, Area Distributor, or Dealer, the Company hereby agrees with the original purchaser to entirely rebuild and re-condition such Kirby, when returned to The Kirby Co., Division of The Scott & Fetzer Company, Cleveland, Ohio, any time after the expiration of the WARRANTY and as often as may be required, providing it is still the property of, and in the possession of, the original purchaser as set forth in the following.

1. The Company, in rebuilding and re-conditioning the machine for the original purchaser, will make every effort to keep the cost to such purchaser for this service as low as possible, and the Company will in no case charge such purchaser more than \$37.50 for any one rebuild.
2. The Company's maximum price of \$37.50 shall include all labor and cost of parts necessary to put all Kirby equipment included in the original purchase in A-1 condition.

Transportation charges (and replacement costs of broken parts) or missing parts, are, of course, extra charges

### COVERAGE OF LOSS BY FIRE

Subject to the conditions and exceptions stated in this Kirby General Coverage Warranty, and further subject to the condition that the Kirby described has been originally purchased from an authorized Kirby Distributor, Area Distributor, or Dealer, the Company agrees:

1. In the event that this Kirby, while owned by and in the possession of the original purchaser, should be damaged by fire, on the premises of such purchaser, the Company will repair or rebuild the Kirby for the such purchaser and return it in A-1 condition, providing that such purchaser will send \$37.50 and the fire damaged remains, prepaid, to the Company's factory in Cleveland, Ohio, within ninety (90) days after damaging fire. If cleaning tools also need replacing by reason of fire damage, an additional charge of \$8.00 will be made. Return transportation to such purchaser's home will be paid by such purchaser.

If the Kirby Miracle Head® Handi Butler, or Flexible Shaft, are damaged or destroyed by fire, the Company will replace the Kirby Miracle Head® at a cost of \$7.00 to the customer; the Kirby Handi Butler at a cost of \$13.00; the Kirby Roll-O-Waxer at a cost of \$10.00; the Kirby Rug Renovator at a cost of \$13.00; all f.o.b. Cleveland, Ohio.

This service is based upon the conditions that such purchaser has met with all the requirements of the original purchase agreement, and it is distinctly understood that said replacement will in no way nullify or modify the terms of that purchase agreement. If the fire damaged Kirby has not been fully paid for under an installment purchase plan, a statement from the distributor certifying that installment payments are current will be required.

2. In the event that the Kirby, Kirby Attachments, Miracle Head®, Handi Butler, Roll-O-Waxer, or Rug Renovator, while in the possession of the original purchaser shall be completely and wholly destroyed by fire so that no damaged parts can be returned, an affidavit, sworn to by the original purchaser before a notary public, will be accepted within ninety (90) days after the date of the damaging fire in lieu of damaged parts, and the Kirby and/or attachments will be completely replaced under the terms set forth in Section 1 above.

THE KIRBY COMPANY  
DIVISION OF THE SCOTT & FETZER COMPANY  
CLEVELAND, OHIO

Manufacturers of the  
Kirby Classic  
WARREN J. BLANKE, President

Service calls, including the one-year warranty period, will be at the expense of the owner.

### PLEASE COMPLETE THE FOLLOWING

The above Warranty covers the Kirby Classic.

Serial No. T114631  
Date of Delivery Aug 22, 1971  
Rodney Church  
Authorized Dealer Signature 694-26