

collectingdust.com

Guarantee
and Instruction
Book



509 KIRBY SANITATION SYSTEM

collectingdust.com

YOUR Kirby Distributor

IS AS NEAR TO YOU

AS THE

Telephone



YOUR KIRBY DISTRIBUTOR'S NAME IS:

THE SCOTT & FETZER COMPANY

Manufacturers of the Kirby Vacuum Cleaner System

WEST 114th ST. and LOCUST AVE.

CLEVELAND 2, OHIO, U. S. A.



CONTENTS

| | Pages | Illustration Numbers |
|---|-------|----------------------|
| In general | 2 | .. |
| Keep this booklet | 3 | 1 |
| A Suggestion | 3 | .. |
| The names of the Kirby parts | 4-5 | 2 |
| Instructions for operation: | | |
| Assembling the machine | 6 | 3 |
| Electrical connections | 6 | .. |
| Safety switch | 6 | .. |
| Floor nozzle | 7 | 4 |
| To put nozzle on motor unit | 7 | 5-6 |
| To remove floor nozzle | 8 | 7 |
| Nozzle height adjustment | 8 | 8 |
| Bag assembly | 9 | .. |
| Sani Em-tor | 9 | .. |
| To empty dust bag with Sani Em-tor | 9-10 | 9-10 |
| Tilt latch | 10 | 11 |
| Kirby units and uses: | | |
| The American Home Chart | 11 | 12 |
| Crystalator | 12 | 13 |
| Spray Gun | 13 | 14 |
| Floor Portable | 14 | 15 |
| Shoulder Portable | 15 | 16 |
| Hand Portable | 15 | .. |
| Rug Cleaner | 16 | 17 |
| Duster and Buffer | 17 | 18 |
| Power Polisher | 17 | 19 |
| Maintenance of your Kirby at top efficiency: | | |
| Brush cleaning | 18 | 20 |
| Brush adjustment to take up bristle wear | 18 | 20 |
| Brush replacement | 19 | 20 |
| Installation of new belt | 19 | 20 |
| Floodlight bulbs | 19 | .. |
| Lubrication | 19 | .. |
| Special notice | 19 | .. |
| Kirby Cabinet | 21 | .. |
| Kirby general coverage guarantee | 22 | .. |
| Kirby service insurance | 23 | .. |
| Coverage of loss by fire | 23 | .. |



THE SCOTT & FETZER COMPANY

Manufacturers of the Kirby Vacuum Cleaner System

WEST 114th ST. and LOCUST AVE. CLEVELAND 2, OHIO, U. S. A.

PRINTED IN U.S.A.

IN GENERAL . . .

THE KIRBY VACUUM CLEANER SYSTEM is designed to serve you efficiently and dependably in the removal of dust and dirt from your home and its furnishings.

DIRT is a costly robber of house furnishings and its removal saves you money, time and trouble.

THE KIRBY is delivered to you shiny-new and in perfect adjustment, all ready to be set up and put to work. You start with the best vacuum cleaner in the world and it will continue to give you the best of cleaning service if you give it a reasonable amount of care.

ITS USES to clean every part of your home are shown on "The American Home Chart." See page 11 of this booklet.

THERE ARE MANY DESIRABLE AND VALUABLE FEATURES designed and built into the Kirby:

SANI EM-TOR . . . eliminates the muss and fuss of the dirty job of emptying the bag in the usual way.

TRIPLE-CUSHIONED VIBRATION . . . the mechanical action that lifts the carpet and shakes loose the deeply embedded grit and dirt—no harmful pounding because the carpet is lifted up into the opening of the nozzle and the vibrating and brushing action of the rotating brush takes place with the carpet resting on a cushion of air. The carpet nap is flexed open and the brush gently loosens the embedded grit and dirt, which the suction swiftly carries into the dirt container.

TOE-TOUCH CONTROL . . . this semi-automatically adjusts the height of the nozzle in relation to the nap of the carpet, in order to secure the maximum cleaning efficiency and ease in the guiding of the machine. It is the best of such devices because it doesn't get out-of-order, requires no stooping, and is accurate in adjustment.

SAFETY SWITCH . . . prevents any possibility of accidents in the operation of the machine.

BELT LIFTER . . . makes it easy to attach the various specialized cleaning tools.

START-STOP SWITCH . . . constructed to withstand the force of thousands of foot operations without a murmur. It is practically indestructible and eliminates the main source of trouble which you may have experienced in other cleaners which do not have this feature. In the Kirby,

no wires extend from the motor unit except for the easily replaced extension cord.

KEEP THIS BOOKLET . . . It contains vital information concerning the effective and useful operation of your Kirby vacuum cleaner system. There are many uses, methods of application, and set-ups of the various units of the machine that are not mentioned in this booklet. However, after you have read it, you will have a good idea of the things into which the designers and manufacturer of the KIRBY have put much work, thought and money. It has always been their object to design the best vacuum cleaner in the world and then, by the most efficient of production methods, to keep the price as low as possible. In this way you have the greatest value possible. Yes, keep this booklet and review it every once in a while. It will help you to get the most value out of this very valuable household machine.

A SUGGESTION . . . Locate a hook in a closet, or on the inside of a closet door where the Kirby Kabinet can be hung when not in active use. This is the most compact way for storing your machine and cleaning tools. When it is necessary to have the tools to do the various kinds of cleaning throughout the house, just take the Kirby Kabinet down off of the hook and carry it to the job. See pages 22-23 of this booklet for illustrations. Also, the large box in which the machine is originally packed, can be used for storing blankets or other similar things.

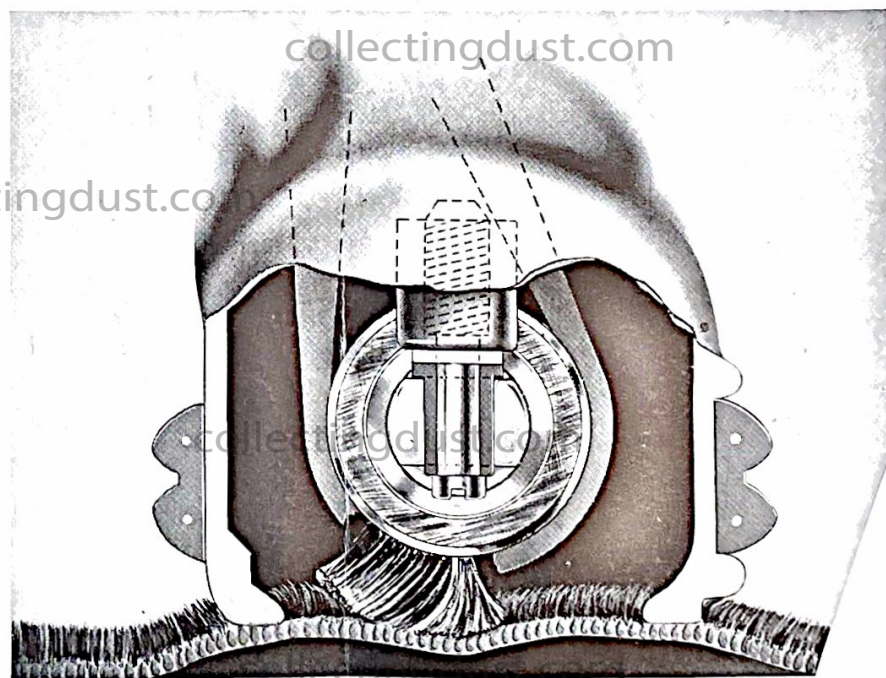

Illustration No. 1
TRIPLE-CUSHIONED VIBRATOR

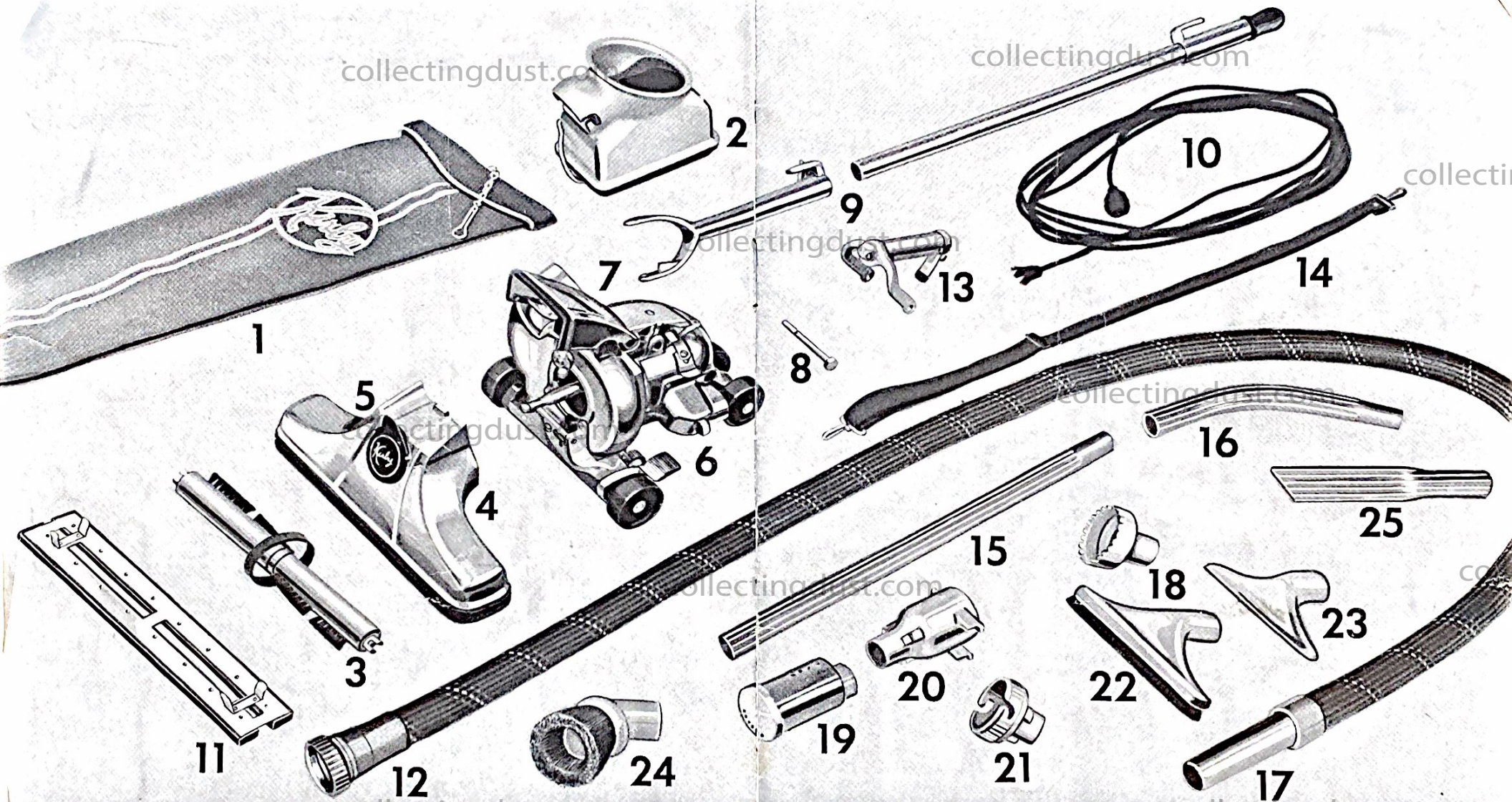

Illustration No. 2

THE NAMES OF THE KIRBY PARTS . . . We will need to know them in our discussion of the Kirby operation. Also, this list is useful in the ordering of parts.

MAJOR PARTS

- | | |
|----------------|---------------------|
| 1. Bag | 6. Motor Unit |
| 2. Sani Em-tor | 7. Floodlight Cover |
| 3. Brush Roll | 8. Handle Pin |
| 4. Rug Nozzle | 9. Long Handle |
| 5. Belt Lifter | 10. Cord |

AUXILIARY TOOLS

- | | |
|----------------------------------|--------------------------|
| 11. Floor Duster and Buffing Pad | 18. Massage Cup |
| 12. Flexible Hose | 19. Crystalator |
| 13. Lifter Grip | 20. Suction Coupler |
| 14. Shoulder Strap | 21. Blower Coupler |
| 15. Straight Extension Tube | 22. Utility Brush Nozzle |
| 16. Curved Extension Tube | 23. Utility Air Nozzle |
| 17. Coupler Tube | 24. Duster Brush |
| | 25. Crevice Tool |

INSTRUCTIONS FOR OPERATION

ASSEMBLING THE MACHINE . . . on removal from the box, the handle is the first thing to be put together. It is packed in two sections in order to save packing space. Insert the upper section of the handle into the handle fork. A "stop" inside the handle fork allows only 1½" of the handle tubing to be inserted. Make sure that the hook for the cord on the upper section of the handle and the hook for the cord on the handle fork, are in line with each other. Then securely tighten the screw in the clamp at the joint with a screw-driver. This is the only time you will have to do this operation.

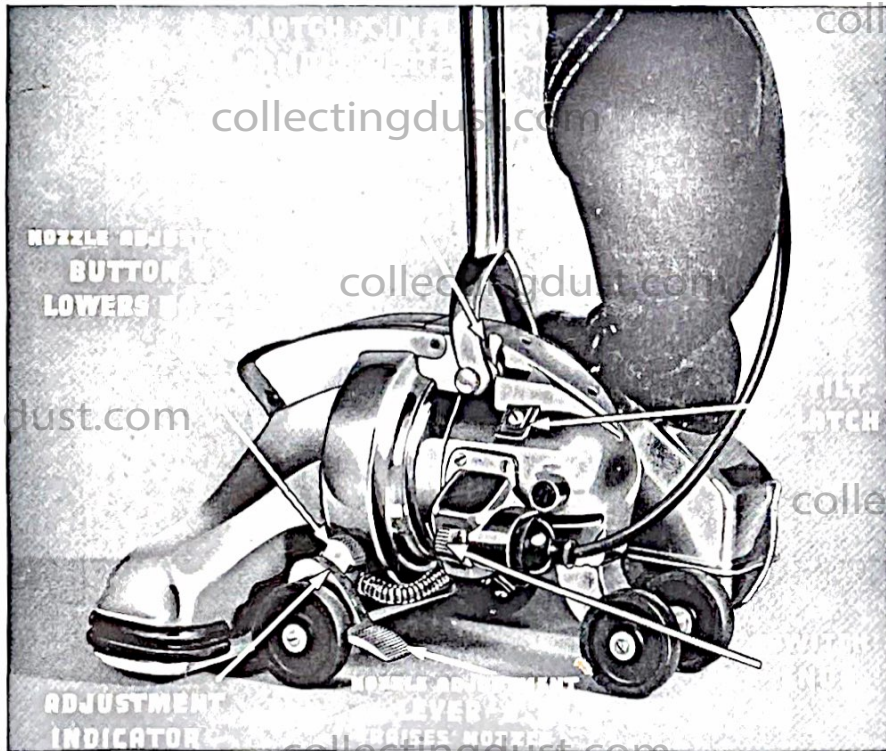

Illustration No. 3

ELECTRICAL CONNECTIONS . . . Plug the extension cord end into the Start-Stop Switch. Place the wire loop of the cord over the small hook on the rear of the handle and wind the cord downward around the bottom hook on the handle. Then wind the cord upward around the top hook. This way of wrapping avoids any tension on the switch due to the raising and lowering of the handle.

SAFETY SWITCH . . . This is another exclusive Kirby feature. The motor will not operate except when the nozzle or suction connector has been properly affixed. Don't call a service man until you have checked this operation.

FLOOR NOZZLE . . . As delivered to you in the box, the nozzle contains the brush roll (Triple-cushioned Vibrator) and the belt that drives it. Before attaching the nozzle to the motor unit it will be necessary to stretch the belt over the belt lifter. The belt lifter hook is an integral part of the name-plate on the nozzle and cannot be removed. Hold the nozzle in the palm of the left hand with the nozzle name-plate side down. Grasp the belt lifter nozzle cap "lever" with the right hand and turn it to the UP position. Look in the round opening. Then rotate the lever, as far as it will go. Make sure that the loop of the belt is caught by the tongue of the belt lifter, as seen on the inside through the round hole on the back of the floor nozzle. The belt is then in position for the attachment of the nozzle to the motor unit and need not be touched again until it becomes necessary to remove the belt or revolving brush.

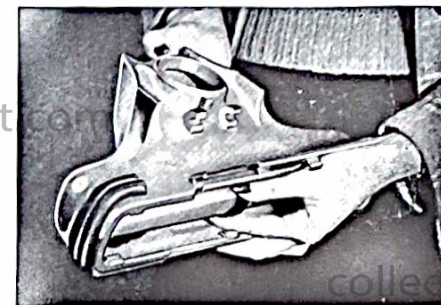

Illustration No. 4

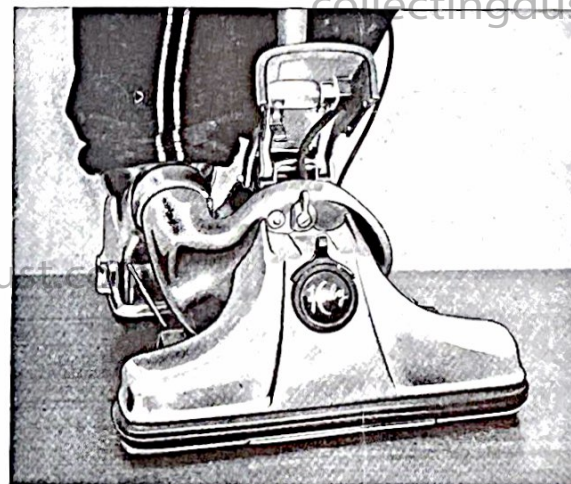

Illustration No. 5
Position of the belt lifter when belt is lifted from shaft.

IMPORTANT!
Belt should always be on belt lifter before nozzle is attached to machine.

Illustration No. 6
Position of the belt lifter when belt is driving brush.

TO PUT NOZZLE ON MOTOR UNIT . . . In preparation, raise the motor unit to the top height, position seven, of the Toe-touch Control adjustment Illustration 7. Lever A is used for raising the nozzle, and button B is used for lowering the nozzle a notch at a time. Then raise the floodlight cover and the nozzle cam lock is exposed. Then hook the nozzle support over the horizontal shaft on the fan case, directly under the motor shaft. When the nozzle support hooks are properly placed, the lip in the center of the nozzle top will slide under the nozzle latch or cam lock, provided the end of the latch lever rests on the protruding pin, located next to it. Lift the handle of the cam off the pin and rotate to the right as far as it will go, and press down snugly. Turn the name-plate belt-lifter lever until it is vertical and the name "Kirby" is in a readable position.

TO REMOVE FLOOR NOZZLE . . .

In preparation, raise the motor unit to the top height, according to the Toe-touch Control adjustment. Raise the floodlight cover. While facing the machine, turn the name-plate belt-lifter lever as far as it will go to the left. Turn the cam lock lever to the left until the end of the lever rests against the stop pin. The top of the nozzle will then fall forward.

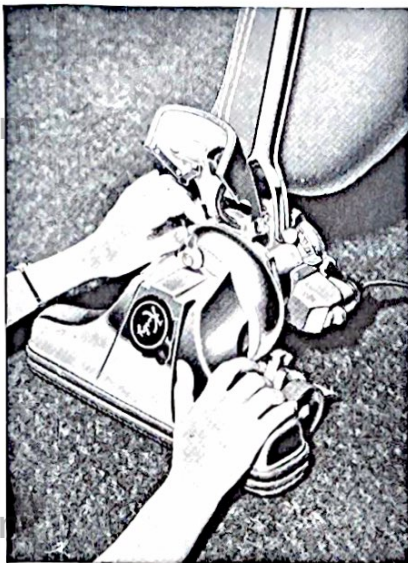

Illustration No. 7

NOZZLE HEIGHT ADJUSTMENT

with Toe-touch Control . . . The many types of floor coverings in use make it important that your vacuum cleaner nozzle be conveniently, quickly and accurately adjusted to suit. The Toe-touch Control mechanism is used for such raising and lowering of the nozzle (Illustration 7). Lever *A* is used for raising the nozzle, and button *B* is used for lowering the nozzle a notch at a time. These adjustments are made with the foot, the proper way to secure the accurate height of the nozzle, at which point the most effective cleaning action takes place, combined with the easiest movement of the Kirby over the carpet. Place the cleaner on the rug or carpet, press down on Lever *A* and raise the setting or adjustment to No. 7 on the indicator. Start the motor and lower the nozzle by pressing on Button *B* with the toe, a notch at a time until you see the rug drawn up to the nozzle by the suction and a noticeable deepening or rumbling in the sound of the motor occurs. Then you will have the best nozzle adjustment.



Illustration No. 8

For thorough cleaning, do not push the cleaner too fast, because it will "break the suction" and stop the cleaning action for a few seconds until the suction power is "built up" again. For best cleaning action, move comparatively slowly. If the cleaner does not pick up threads and lint, look at the belt which drives the rotary brush and

see if the tension is such that the brush rotates when held lightly against the carpet nap. Also, the brush must be clean and the length of the brush bristles adjusted properly. Remember if the machine has that certain low, business-like rumbling sound and glides easily over the rug, you have it correctly adjusted. If it pushes hard, it is adjusted too far downward. If it has too high a sound, a high-pitched whine, it is too high off the face of the rug.

BAG ASSEMBLY . . . A garter spring sewed into the bottom of the bag holds it securely to the Sani Em-tor. The bag should never be removed except to attach a new one.

SANI EM-TOR . . . In order to affix the Sani Em-tor to the motor unit, lay the machine on its side, with the exhaust opening on the up side. Place the Sani Em-tor opening's lugs over the pins on the exhaust opening and press into place. Hook the bag support wire loop to the hook attached to the handle grip.

TO EMPTY DUST BAG WITH SANI EM-TOR . . .

Spread a fully opened sheet of newspaper on the floor, place the machine (with dust bag and Sani Em-tor attached) in the center of the paper, and lower the floor nozzle, using the Toe-Touch Control, as far as it will go. Unhook the bag support wire loop from the hook attached to the handle grip and, holding the bag in a taut position, shake vigorously to drop the dirt, contained in the bag, down into the Sani Em-tor (See Illustration 9). Then rotate the cam lock lever on the Sani Em-tor. Swing the bottom part of the Sani Em-tor from under the machine, turning it over so that the dirt, resting in the cup of the bottom part, will drop down onto the paper. Also, the dirt contained in the bag and the Sani Em-tor will drop on newspaper (See Illustration 10).



Illustration No. 9

While the bottom of the Sani Em-tor is still open shake the sides of

the bag and push the dirt down into the Sani Em-tor. This will force out through the Sani Em-tor the fluffy, bulky refuse which clings to the walls of the bag. Replace the bag support wire loop upon the handle hook. Now swing back into place and lock with the lock lever. The dirt from the cleaner can then be wrapped in the newspaper and the package easily disposed of.

TILT LATCH . . . (Illustration 11). There are three handle settings: (1) The position in which the latch is slid upward as far as it will go. This disengages the latch from the handle and permits the handle to swing freely in an arc. This is the setting for pushing the machine under beds or similar low pieces of furniture. (2) To make this setting, raise the handle to a straight-up position and push the Tilt Latch slide down as far as it will go. Then, when you pull the handle back, you will find there is a point where it stops and added pressure put on the handle tilts the machine. In this way, the machine is tilted over the edges of rugs, when going from room to room. Also, this setting is useful in cleaning fringed rugs. (3) With the latch in the UP position, swing the handle down as far as it will go. Then lock the handle in this position by sliding the latch downward as far as it will go. This setting holds the handle and machine in a straight-out, rigid position suitable for cleaning stairways, mattresses, and overstuffed furniture seats.



Illustration No. 10

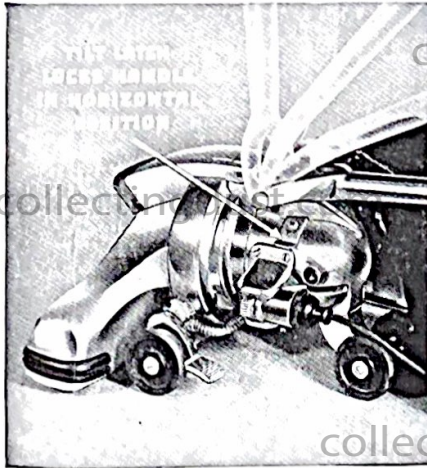

Illustration No. 11

THE MULTITUDE OF USES OF

IN THE AMERICAN HOME

1
CRYSTALATOR



- BEAMS
- PELOWS
- BLANKETS
- SUITS
- OVERCOATS
- COMFORTERS
- SWEATERS
- QUILTS
- BATHING SUITS
- CAPS
- MASTERS
- GOWNES
- and All Other Wetness and Fabrics

2
MOTH and INSECT PREVENTION



- UNDER
- BEAMS
- BASEBOARDS
- SCREENS
- INTO
- CUPBOARDS
- CHESTS
- DRAPES
- GARAGE CARS
- PAINTS
- DRAIN PIPS
- BOOK CASES
- DAMP PLACES
- TRUNKS
- PAROIS
- UNPOLISHED FURNITURE
- CRACKS
- CETICES
- BEAMS
- MOLLOW SPACES
- AND
- facings the gaps and
- penetrates through texture
- and into inaccessible places.

3
FLOOR PORTABLE



- LACE CURTAINS
- WINDOW SHADES
- WINDOW DRAPES
- PAROIS
- BASEBOARDS
- WALLS
- REGISTERES
- RADIATORS
- CARVED WOODWORK
- STONE FIREPLACES
- DRAWERS
- and all other hard surfaces.
- OVER
- DOORS
- WINDOWS
- CEILING
- WALLS
- PICTURE FRAMES
- UNDER
- LOW PLACES
- BOTTOM SIDE OF FURNITURE
- at high and low places.

4
SHOULDER PORTABLE

- STORAGE LOCKERS
- TRUNKS
- ATTIC
- BASEMENTS
- CLOSETS
- MOORS AND CORNERS
- CLOSET'S
- BEAMS
- ROTES
- FURNACE PIPS
- WHITE PIPS
- WATER PIPS
- FRUIT CELLARS
- AUTOMOBILES
- CEILING
- FLOOR
- FOR WALLS
- UNPOLISHED



5
HAND PORTABLE

- HEAVY THICK CUSHIONED
- UNPOLISHED FURNITURE
- DAY BEDS
- CARPETS STAIRWAYS
- MATRESSES, etc.



6
TRIPLE-CUSHIONED VIBRATOR

- CARPETS AND RUGS



7
DUSTER & BUFFER

- PAVED WOOD FLOORS
- TILE FLOOR
- UNPOLISHED, etc.

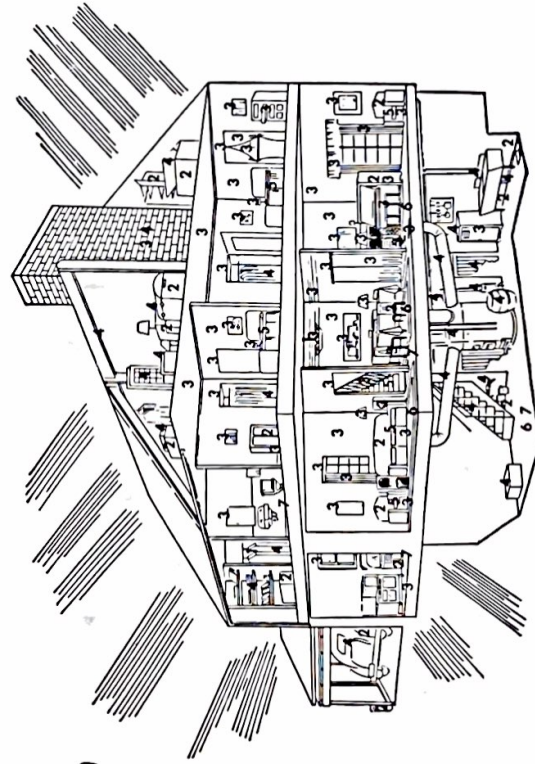

Illustration No. 12

KIRBY UNITS AND USES

CRYSTALATOR . . . This is the Kirby unit used to dispense insect powders or vaporize volatile crystals. It has three settings so that from a dense cloud of vapor to an intense stream of crystals can be produced and made available for the specialized tools to direct into hard-to-get-at, or hard to control places.



(Parts used in the operation of the Crystalator: Motor unit with electric cord, lifter grip, suction coupler, blower coupler, flexible hose, coupler tube, radiator tool and the Crystalator, itself.)

Attach the Lifter Grip to the unit and turn the snap lock into place the Suction and Blower Couplers. The Blower Coupler is attached to the Exhaust opening in the Motor Unit in place of the Sani Em-tor. Now the machine is ready to have the Crystalator loaded with powder or crystals.

The aluminum cap on the Crystalator can only be taken off or put on when the arrow on the rim of the cap is in line with the arrow on the body of the Crystalator. Holding the Crystalator in one hand, remove the cap and fill the Crystalator three-fourths full. The large holes should be on top. Care should be taken not to spill any crystals during this loading operation. Replace the cap. Slide the tongue on the Crystalator into the groove on the Suction or Intake Coupler. It can only go on in the correct position with the holes on the top of the body of the Crystalator. (See Illustration 13.)

On the rim of the aluminum cap are the markings, "Gas," "Medium" and "Full." With the machine in operation, the powder or crystal material is automatically fed into the air stream. The flow of material is controlled with the adjustment indicated on the edge of the cap. The desired adjustment reading is turned until it is in line with the arrow stamped on the body of the Crystalator. When the motor is turned on, an instantaneous blast of gas or powdered crystals will be blown through the Exhaust Opening or Hose.

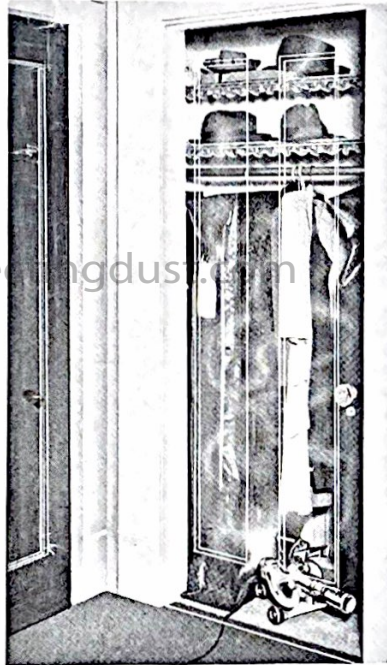
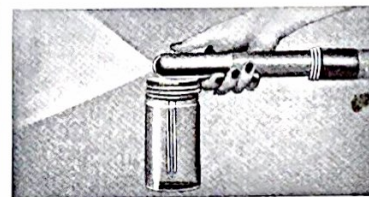

Illustration No. 13

Place the Motor Unit with the loaded Crystalator attached to it in the clothes closet (no hose is used with this set-up). Run the electric cord under the closed door and have the Start Switch set so the machine will start when the cord is plugged into the wall socket. Run the machine for half an hour or more. The crystals will be converted into gas in a matter of two or three minutes, but the running of the machine for a longer time is necessary to circulate the gas into every corner and crevice of the closet.

In order to direct the flow of gas or crystals into, under, over and around, in other words, the hard-to-get-at places, special tools will have to be attached. The Flexible Hose is attached to the Exhaust Coupler. The Coupler Tube and the Crevice Tool or the Utility Air Nozzle are fitted together and inserted in the open end of the Flexible Hose.

SPRAY GUN . . . This is the part used to spray liquids, such as paints, insecticides and floor wax. It is optional equipment.



(Unit and parts used in the operation of the Spray Gun: Motor unit, electric cord, lifter grip, suction coupler, blower coupler, flexible hose, coupler tube, and the Spray Gun itself.)

Attach the Lifter Grip, Suction and Blower Couplers to the Power Unit. Attach the Blower Coupler to the Exhaust Opening in the Motor Unit in place of the Sani Em-tor and Bag. Attach the Flexible Hose to the Blower Coupler and insert the Coupler Tube which is then inserted into the Spray Gun's metal tube end.

The Spray Gun Jar is now ready to be filled or loaded. Unscrew the jar and pour in an amount sufficient to do the job, or not more than three-fourths of the jar, to avoid spillage.

Test the spray by pressing down the plunger with the motor and fan running. Adjust the spray by screwing the plunger up or down. It is a very sensitive adjustment, producing a spray from very fine to almost a solid stream.



Illustration No. 14

Insecticides and liquid waxes made of a thin consistency can be used in the spray gun as they come from the manufacturer's container. However, brushing paint is usually thick and needs to be thinned when used in a spray gun. Use according to the manufacturer's directions. Jar and metal tube should be thoroughly cleaned after using.

FLOOR PORTABLE . . . This is the unit used to clean above-the-floor things, such as draperies, Venetian blinds, lamp shades and mouldings. It is designed to be pulled over the floor on wheels, lifted upstairs or into an automobile, with a lifter grip handle.



(Unit and parts used: Motor unit, Sani Em-tor and bag, electric cord, lifter grip, suction coupler, flexible tube, coupler tube, and utility air-nozzle. Duster brush, utility brush-nozzle and long curved extension tube are optional, depending upon the work to be done.)

Unhook electric cord and wire bag loop from long handle, then remove the handle after pulling out the handle pin. Replace the floor cleaning handle with the lifter grip. Set the lifter grip in place by resting it in the groove located near the hole for the handle pin. Affix by inserting the handle pin. To remove floor cleaning nozzle, lift the floodlight cover, turn the belt lifter lever, raise the machine to the highest adjustment point of the Toe-touch Control, turn the nozzle lock and lift off. Put into place the suction coupler, lock and lower floodlight cover into working position.

Attach the hose to the suction coupler that is in place, on the motor unit. Attach the bag support chain to rear eye on the lifter-grip. The coupler tube, utility air nozzle and utility brush nozzle are then put into position ready for the cleaning operation.

The utility brush nozzle brushes up the nap on upholstered furniture and the strong suction carries away the lint and dirt. Also, it can be used in the cleaning of stair treads and risers and surfaces of various types. The utility air nozzle is used to clean curtains and draperies.

The Curved Extension Tube, when inserted into the set-up, lengthens the user's "reach," and aids in getting the dirt from the high places (such as moldings, tops of doorways and draperies, and the usually inaccessible low places (such as under chairs or cupboards).



Illustration No. 15

The Duster Brush, optional extra equipment, with its long flexible bristles and soft rubber center, is designed to loosen the dust from corners and delicate surfaces, such as polished or scroll woodwork, furniture or lamp shades.

SHOULDER PORTABLE . . . This is the unit used to clean automobile interiors, lighting fixtures, the tops of furnace pipes, spray fruit trees or used any place where it is advantageous to leave the hands free to climb ladders or control moving objects.



(Unit and parts used: Motor unit, Sani Em-tor and bag, electric cord, lifter grip, suction coupler, flexible hose, plastic tube, utility brush-nozzle, utility air-nozzle, duster brush, radiator tools and shoulder strap.)

To set up the Shoulder Portable Unit, attach the suction coupler, flexible hose, and connector tube, to the Motor Unit. The Sani Em-tor and bag unit is in place for all cleaning operations and is removed so the Blower Coupler can be attached, when any "blowing" operations are to be performed.

Since this unit is used in a variety of situations, it would be convenient to have a small apron with pockets big enough to hold and made easily accessible the special cleaning tools. The right tool makes it easier to do a good job.

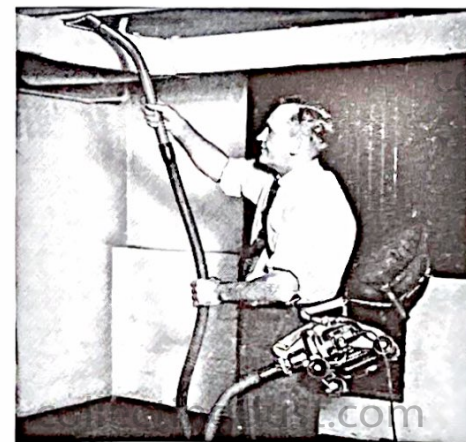

Illustration No. 16

HAND PORTABLE, with Revolving Brush . . . This is the unit used for the cleaning of mattresses, large upholstered pieces of furniture, and stair way treads. Also, when the Power Polisher is attached, it can be used for polishing waxed tops of tables and cupboards.



(Unit and parts used: Motor unit, Sani Em-tor and bag, electric cord, lifter grip and floor nozzle.)

Attach Sani Em-tor and bag to the exhaust opening of the motor unit and attach bag support chain loop to rear eye on the lifter grip, which is substituted for the long handle. The Floor Nozzle is in place and the belt in driving position on the shaft.

When using this set-up on tufted mattresses, the Belt Lifter Lever should be turned so as to disconnect the belt.

RUG CLEANER . . . This is the unit used to clean rugs and carpets.

(Unit and parts used: Motor unit, electric cord, long handle, floor nozzle, Sani Em-tor and bag.)



Illustration No. 17

Attach the long handle to the motor unit by holding the handle in a vertical position over the handle connection on top the motor unit. The lug inside the left arm of the handle fork must fit in the V-shaped notch in the plate at the left end of the handle connection. Insert handle pin through handle fork arms and the motor unit.

The Sani Em-tor, its attachment to the Motor Unit and the method of operation, are described on page 9.

The attachment of the Floor Nozzle is described on page 7, and on page 8 the Nozzle Height Adjustment is shown.

On page 10 the Tilt Latch is presented.

DUSTER AND BUFFER . . . As the name implies, this set-up is used for the dusting of hardwood, linoleum, or other hard surfaced floor materials. Then, after wax has been applied, the same tool is used to secure a high polish.

(Unit and parts used: Rug cleaning unit, and the felt padded buffer.)

Tilt the nozzle of the machine up so it is easy to place and snap on the felt pad, which is equipped with metal clip for that purpose.

POWER POLISHER . . . This is the unit that is used to polish hard-surfaced floors after they have been waxed. This is optional equipment. The Power Polisher brush, pressed to the floor by the weight of the machine and guided just by the light touch of the hand, is all that is necessary to have a high polish quickly on hard floors.

(Unit and parts used: Power Unit, long handle and polisher nozzle.)

Remove the Rug Cleaner Nozzle from the Power Unit. Adjust the Belt Lifter so the belt is stretched and ready for the Polisher Unit to be placed on the machine. Lock the Polisher Nozzle into place and turn the Belt Lifter, dropping the belt onto the shaft and ready for operation. Lower the brush to the floor with the Toe-touch Control and the machine is ready to operate.



Illustration No. 18



Illustration No. 19

MAINTENANCE OF YOUR KIRBY AT TOP EFFICIENCY

BRUSH CLEANING . . . Keep it clean! Remove the threads and hair that wrap around the brush. A pair of scissors and an old comb are useful tools. Also, remove the brush and clean any collection of hair and lint from around the bearing yokes, found at both ends. It is not necessary to remove the brush adjustment screws in order to get the brush out of the nozzle. Raise the rug guard and lift the brush out with the fingers. If the brush doesn't slip out readily, remove the nozzle from the motor unit and tap on the floor. When replacing brush, large yoke must be fitted to large adjustment screw. The rug guard must be snapped back into place before the machine can be moved along the floor.

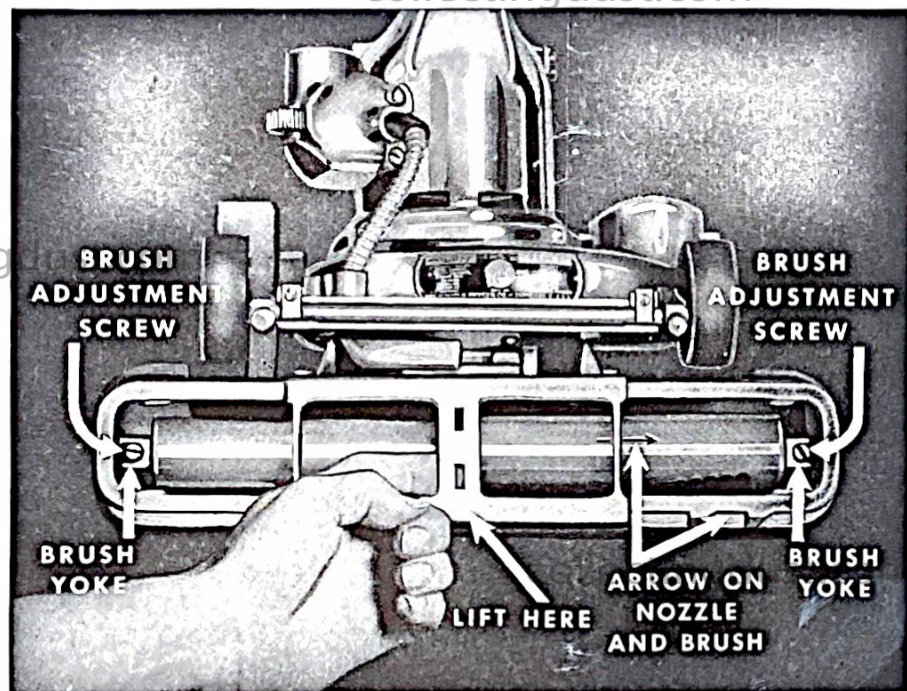

Illustration No. 20

BRUSH ADJUSTMENT TO TAKE UP BRISTLE WEAR . . . As the bristles on the brush wear, it will be necessary to adjust the brush to regain brushing efficiency. Adjust the brush adjustment screws by turning counter-clockwise. Turn the crews the same amount at each end so the bristles extend evenly along the full length of the nozzle. The bristles should protrude $\frac{1}{8}$ " below the nozzle edge. This method of brush adjustment produces much more and efficient brush use than any other because of its accuracy and great number of positions to which it can be adjusted.

BRUSH REPLACEMENT . . . When bristles finally become worn down so short that no further adjustment is practical, the old brush may be sent to the factory or taken to your Kirby distributor and a new brush will be supplied at a nominal charge.

INSTALLATION OF NEW BELT . . . Turn the Belt Lifter so the belt is raised from the shaft, then remove the nozzle. Rotate the Belt Lifter, thereby releasing the belt from the hook. Snap open the Rug Guard and lift one end of the brush out of the nozzle. Slide the new belt over the raised end of the brush until it is over the pulley, or over the open space in the center and between the bristles. Replace brush and lift the belt into place as explained on page 7. Be sure the arrows on the nozzle and the brush are pointing in the same direction.

FLOODLIGHT BULBS . . . To replace, raise floodlight cover, remove bulb and socket assembly from spring clamp that fastens around the metal base of the bulb. The base of the bulb is the bayonet type, similar to those used in automobile headlights. Turn the bulb slightly counter-clockwise, or to the left, push in at the same time, and then pull out. Do not force. If it is done right it will come out with a firm but gentle pressure. Reverse this procedure to install the new bulb. We cannot guarantee the life of the light bulbs. Replacements can be secured from your Kirby distributor, or The Scott & Fetzer Company, Cleveland, Ohio.

LUBRICATION . . . The ball bearings in the motor and in the brush are packed in grease. They should not require any additional grease for a number of years with average use in the home. Should any difficulty develop, consult your Distributor immediately, or write the Factory Service Department for instructions.

NOTICE!

NOTICE! . . . Should you ever have occasion to communicate with the distributor or manufacturer regarding your Kirby, be sure to mention the model and serial number of the machine as shown on the name-plate located on the bottom of the fan case.

KIRBY KABINET

ACCESSIBILITY . . . This is a prime requisite if the utmost use is to be made of your Kirby Home Renovation System. Carry the Kabinet with you and hang it on a door-knob, chair-back, or any place where the tools will be readily at hand. Use the tools for the tasks for which they were specifically designed and make your work easier, faster and more efficient.

STORAGE . . . This is a problem in most homes which can be solved by the use of the Kirby Kabinet. Rarely can you find a use for the back of a closet door. However, this compact tool-storage cabinet can be hung there very easily. Try it! Place your Kabinet there and see how snugly it can be stowed away.

READILY ACCESSIBLE!

STORE EASILY!

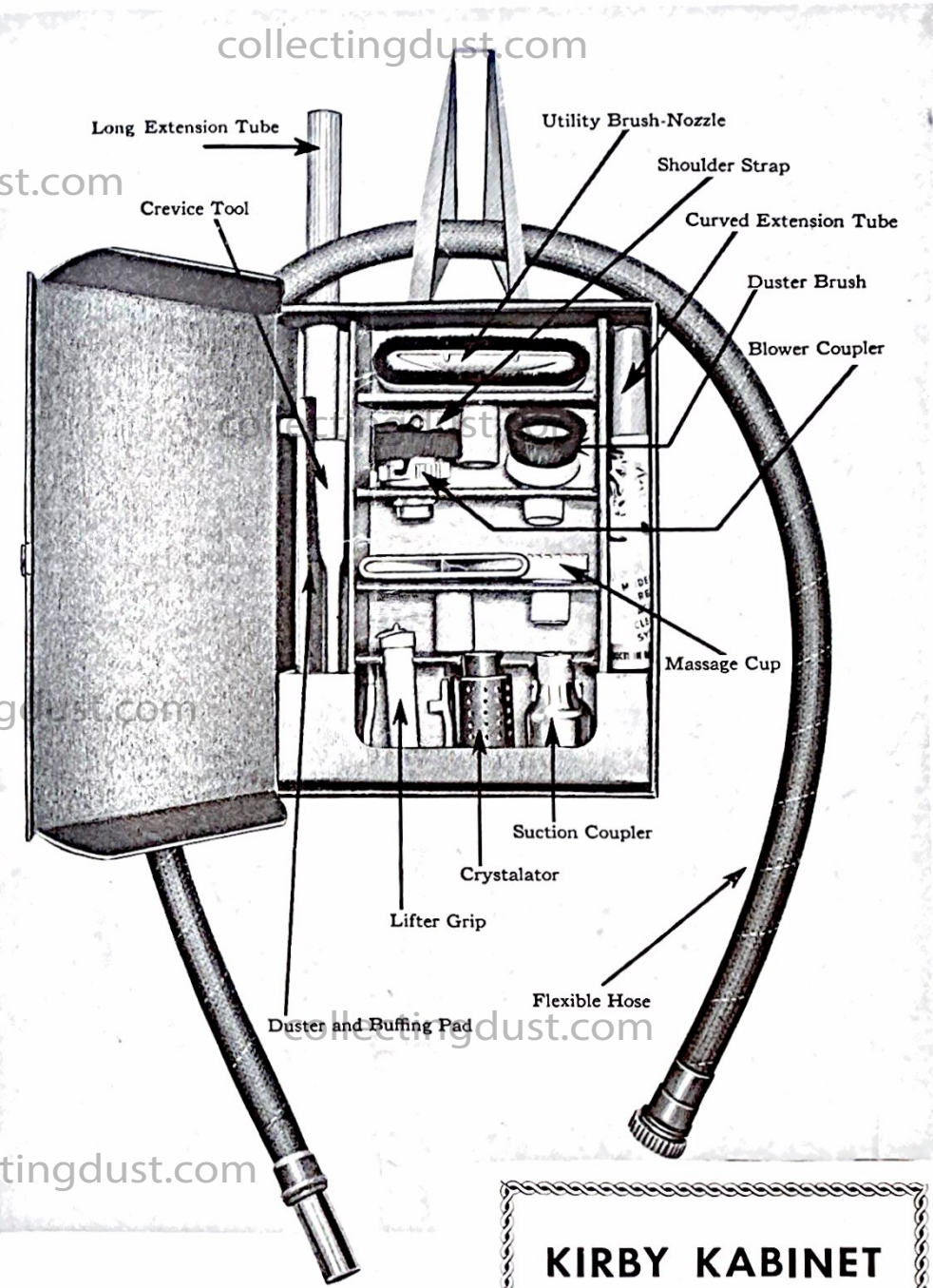
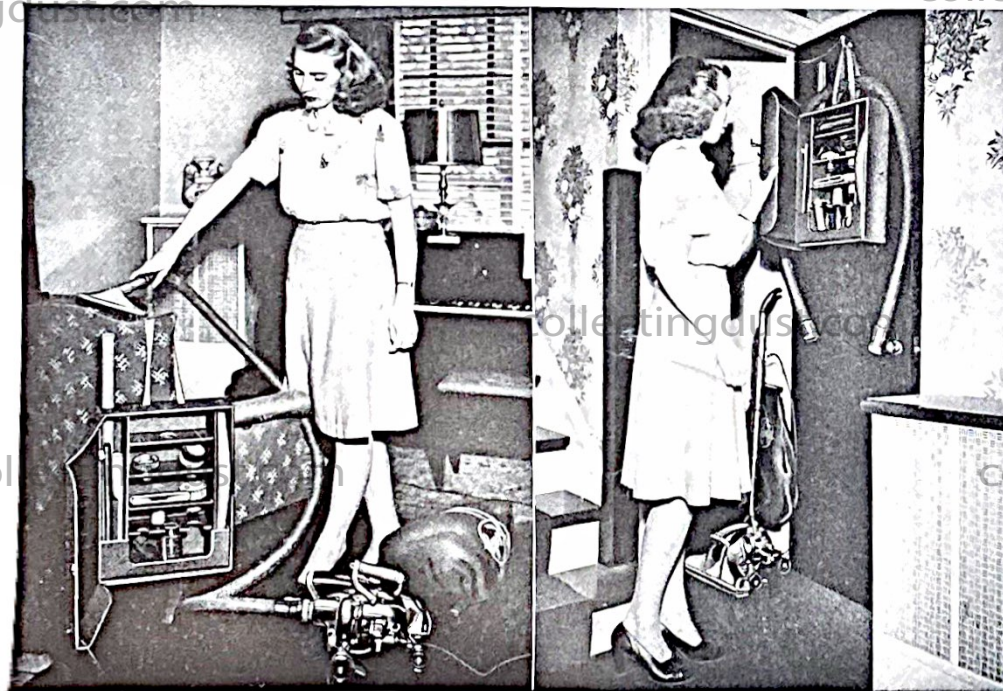

KIRBY KABINET
 FOR CONVENIENCE IN
 HANDLING AND
 STORAGE

KIRBY GENERAL COVERAGE GUARANTEE

THE SCOTT & FETZER CO. — Manufacturers
Cleveland, Ohio

THIS CERTIFIES that this Kirby Cleaner has passed a thorough inspection and test, has met all requirements and, the established list price having been paid by the purchaser, is guaranteed by the manufacturer as follows:

During one year from date of purchase, the Company after due examination will replace or repair any part the Company judges defective in material or workmanship. Delivery of such part, or the Cleaner itself, must be made prepaid to the factory or authorized Distributor during the period of the guarantee. Under any other circumstances a service charge will be made for sending a service representative to call for or deliver any cleaner or part.

Replacement of belts will not be made gratis, as the amount of use and the care given the brush assembly determines their length of life. We cannot guarantee the life of light bulbs.

If you cannot locate a nearby Distributor for required service, write The Scott & Fetzer Company, Cleveland 2, Ohio, for instructions.

Read the Instruction Book thoroughly, as failure to follow instructions may injure the cleaner and cause trouble for which the Company will not be responsible. The Company will in no case be responsible for damage or breakage caused by accident, misuse, abuse or damage resulting from owner's tampering or repairs attempted by unauthorized service men.

No verbal or written agreement on the part of the salesman or Distributor other than contained herein is valid or binding on the manufacturer and should not be accepted by the purchaser.

President

THE SCOTT & FETZER CO. — Manufacturers

This Guarantee
Covers Kirby

Serial No. _____ Date of Original
of Machine _____ Purchase _____

This is yours . . . Do not relinquish to anyone!

GENERAL SERVICE INSURANCE

For the "Kirby" in the home

The manufacturer and/or distributor hereby agree to entirely rebuild and recondition this Kirby any time after the expiration of the factory guarantee and as often as the original purchaser may require, providing it is still in the possession of the original owner, as set forth in the following:

1. The manufacturer and/or distributor in rebuilding the machine for the purchaser will make every effort to keep the cost to the customer for this service as low as possible and the manufacturer will in no case charge the customer more than \$12.50.
2. The price of \$12.50 (maximum for rebuilding service) shall include all labor and cost of parts necessary to put the machine in A-1 condition and no extra charge will be made other than transportation.
3. A one-year Rebuild Guarantee will be issued to the customer each time such rebuilding service is rendered.
4. This "General Service Insurance" is void if your Kirby is serviced by any other than an authorized Kirby Distributor, and, unless genuine Kirby factory parts are used.
5. Also, this guarantee is null and void if the nameplate has been defaced, removed or changed in any way whatsoever from the condition in which it left the factory.

COVERAGE OF LOSS BY FIRE

1. In the event that this machine, while in the possession of the original purchaser, should be damaged by fire on the premises of the purchaser, the manufacturer will repair or rebuild the machine for the customer and return the equivalent of a new machine of the same model, providing the customer will send \$12.50 and the fire-damaged remains prepaid to our factory; return transportation to the customer's home to be paid by the customer. This service is based solely upon the condition that the purchaser has met with all of the requirements of the purchase agreement and it is distinctly understood that said replacement will in no way nullify the terms of that purchase agreement. In this case a one-year rebuild guarantee will also be issued to the customer.
2. In the event that the machine, while in the possession of the original purchaser, should be completely and wholly destroyed by fire so that no damaged parts can be returned, an affidavit, sworn to by the original owner before a Notary Public, will be accepted in lieu of damaged parts and the machine will be completely replaced under the terms set forth in Section 1 above.

President

THE SCOTT & FETZER COMPANY
Manufacturers of the Kirby
Vacuum Cleaner System.



SANITATION
SYSTEM

The finest in the world!