

collectingdust.com



GIVE YOURSELF MORE LEISURE TIME

WITH



Model 562

KIRBY

SANITRONIC SYSTEM

warranty and instruction book

collectingdust.com

gdust.com

THIS BOOK

is dedicated to you, the owners of the wonderful new Kirby.

It is designed to promote your complete enjoyment of the Kirby Sanitronic System.

Keep this booklet handy. Read and review it often, for by knowing your Kirby completely you will realize full value from your purchase, and appreciate the Kirby as a truly marvelous invention and dependable household friend.

C O N T E N T S

- **YOUR KIRBY**
 - What it does for youPages 2 to 5
 - Its componentsPages 6-7

- **HOW TO USE YOUR KIRBY**
 - Belt LifterPages 8-12-13
 - Toe-Touch ControlPage 9
 - Motor Switch & Handle LockPage 10
 - Sani Em-TorPages 11-17
 - Handi-ButlerPages 14-15
 - Handi-SharpenerPage 15
 - Upright CleanerPage 16
 - Suction Relief VentPage 17
 - Duster BufferPage 18
 - Power PolisherPage 18
 - Basic AttachmentsPage 19
 - Portable UnitsPages 20-21
 - Surface NozzlePage 21
 - CrystalatorPages 22-23
 - Spray Gun, Suds-O-GunPage 24
 - Handi-WaxerPage 30

- **HOW TO MAINTAIN & SERVICE YOUR KIRBY**Pages 25 to 29

- **INDEX**Page 31

- **KIRBY WARRANTY**Pages 32-33



SEE
all the things
YOUR

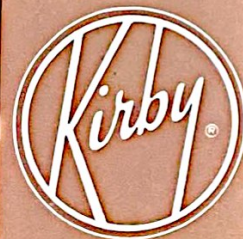

Sanitronic

CAN DO

ON THE
FOLLOWING
PAGES



"No other appliance in the world does as many things for you as your Kirby sanitronic system"



Statement Confirmed by:



HANDI-BUTLER

A versatile power tool for the housewife as well as the man of the house. It sharpens knives, shines and polishes metals.

2

CRYSTALATOR

A complete demothing unit. Gives you a quick, easy, safe and sure method of control, through an exclusive method of quick evaporation of para-crystals.

SPRAY GUN

Sprays lacquer, paint, insecticide, liquid floor wax, plus many other liquids.

SUDS-O-GUN

Generates volumes of extra-dry suds for the safe, efficient and economical shampooing of rugs, tapestries and upholstered furniture.

TANK TYPE CLEANER

Ideal for light dusting and all above-the-floor cleaning.

HAND PORTABLE

Deep cleans mattresses thoroughly, right on your bed. Wonderful for use on upholstered furniture, too.

POWER POLISHER

Polishes any hard surfaced floors right up to the base board and into corners without leaving unsightly streaks.

UPRIGHT CLEANER

Exclusive "Triple Cushion Vibration" assures you of the most efficient cleaning action.

3

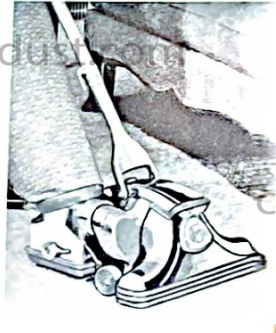



No other appliance is as versatile

or gives you so many *Plus Features*

FLOOR DUSTER-BUFFER

Loosens dirt, buffs and vacuums hard surfaced floors easily and effectively.

SHOULDER PORTABLE

Add the shoulder strap to the floor portable and you have a unit which frees both hands for work in difficult places.

TOE TOUCH CONTROL

Gives you 8 positive adjustments to assure you the proper cleaning height for all floor coverings.

TOOL CABINET

Designed for your convenience in use and storage. Hung on a door knob or back of a chair — tools are handy for use.

SANI EM-TOR

An exclusive Kirby feature which makes it easy to empty the filter bag without fuss or muss.

SANI-POCKET (PATENTED)

Permits you to scrape excess dirt from filter bag into Sani Em - Tor without touching dirt.

SAFETY SWITCH

For your protection against possible injury. As long as the fan blades are exposed, the motor will not run.

SWIVELED CORD HOOK

Permits you to release the cord for use simply by turning the cord hook.

4

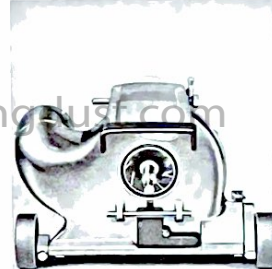
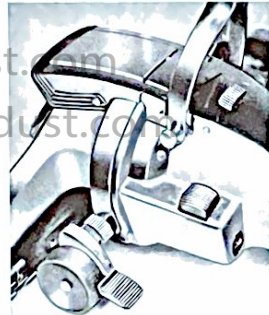

5

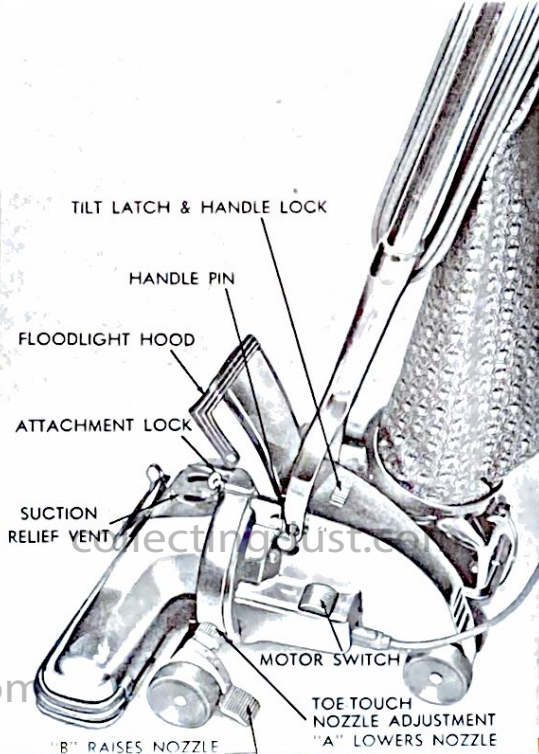

FOR YOUR COMPLETE ENJOYMENT

KNOW YOUR  PARTS

- | | |
|------------------------|--|
| 1. FILTER BAG | 19. MOTOR UNIT |
| 2. FILTER BAG GUARD | 20. CREVICE TOOL BRUSH |
| 3. SANI EM-TOR | 21. DUSTER BRUSH |
| 4. FLOOR DUSTER PAD | 22. MASSAGE CUP |
| 5. LONG HANDLE | 23. UTILITY BRUSH NOZZLE |
| 6. BELT | 24. UTILITY AIR NOZZLE |
| 7. BRUSH ROLL | 25. CRYSTALATOR |
| 8. BELT LIFTER | 26. SUCTION COUPLER |
| 9. SUCTION RELIEF VENT | 27. BLOWER COUPLER |
| 10. RUG NOZZLE | 28. SURFACE NOZZLE — SWIVEL ATTACHMENT |
| 11. PORTABLE HANDLE | 29. HANDI-WAXER |
| 12. HANDI-SHARPENER | 30. CREVICE TOOL |
| 13. HANDI-BUTLER | 31. STRAIGHT EXTENSION TUBE |
| 14. SHOULDER STRAP | 32. CURVED EXTENSION TUBE |
| 15. HANDLE PIN | 33. SPRAY & SUDS-O-GUN |
| 16. POWER POLISHER | 34. HOSE LOCKING NUT |
| 17. CORD | 35. FLEXIBLE HOSE |
| 18. FLEXIBLE SHAFT | 36. SWIVELED COUPLER TUBE |

collectingdust.com

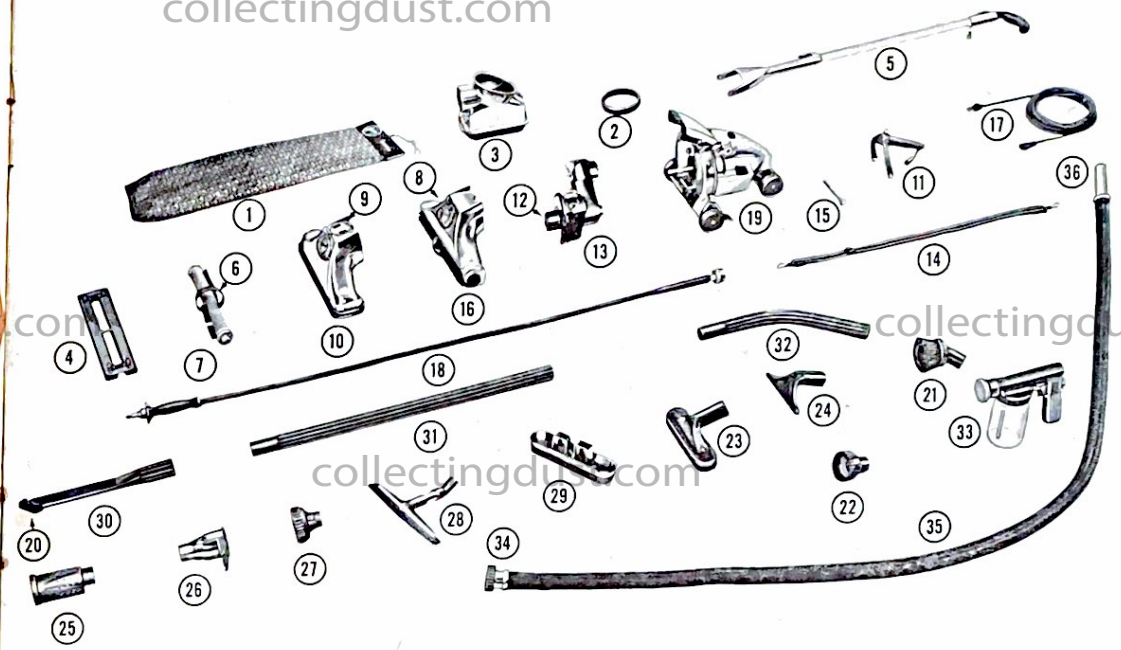

collectingdust.com

Magic Finger BELT LIFTER

Belt lifters are found on the Rug Nozzle, Power Polishers and Handi-Butler. The operation of the belt lifter on the Rug Nozzle and Power Polisher are identical. The belt lifter on the Handi-Butler differs in appearance only (See Figure 2) and is explained on pages 12 and 13.

The Kirby belt lifter makes it easy for you to change units. The belt transmits power from the motor to the Kirby unit. To change units, the belt must be removed from the belt drive shaft and replaced with the belt of another unit. The belt lifter does this for you.

On the front of the Rug Nozzle and the Power Polisher you will find the Kirby Sanitronic name plate. At the top of this name plate is a lever arm which is used in rotating the plate.

As the first step in lifting the belt for attachment, turn the name plate so the lever arm is upright. (See Figure 4). Then look through the round opening at the back of the nozzle and make certain that the belt is standing upright in the center of the brush. Also check the position of the belt on the brush roll by looking at the bottom of the nozzle. It should be in the center. Then turn the name plate counter-clockwise until it stops in position as illustrated in Figure 3. This is the "OFF" position. When the belt is new, it will take a firm pressure to complete the turn. In turning the Belt Lifter to the "OFF" position you automatically pick up the belt on the metal finger and lift it so the Belt Drive Shaft can pass through the loop. (See Figure 1). Your nozzle is now ready for attachment to the motor unit (see page 16). Once it is attached turn the name plate clockwise so the lever arm is again upright. This is the "ON" position and the belt will be properly in place on the Belt Drive Shaft.

Fig. 1



Fig. 2

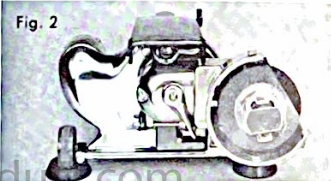

Fig. 3

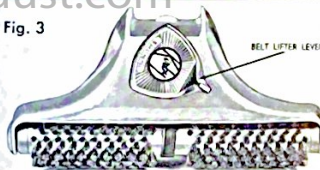
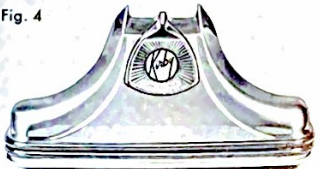

Fig. 4

HOW TO USE
THE TOE TOUCH CONTROL

This exclusive Kirby feature enables you to positively adjust the rug cleaning nozzle to the proper height for efficient cleaning of all floor coverings.

If the nozzle were set too high, there would be no cleaning action. If it were set too low, the cleaning action would be impaired and the machine would be hard to push.

To adjust the Kirby Rug Nozzle properly for your rug, simply depress the large lever (see "B" in illustration) with your toe as far as it will go. This raises the nozzle to the maximum height and the pointer will indicate No. 7 on the adjustment scale.

Now turn on the motor and depress button "A" with your toe. Each time you depress this button the nozzle will lower one notch. Continue to depress this button one notch at a time until you notice a change in tone of your Kirby. This indicates that the nozzle is at the correct level for the thorough cleaning of your carpet.

If the suction is broken with normal movement of the machine, lower the nozzle one more notch.

This same adjustment mechanism is used when operating the Hand Portable or the Power Polisher.

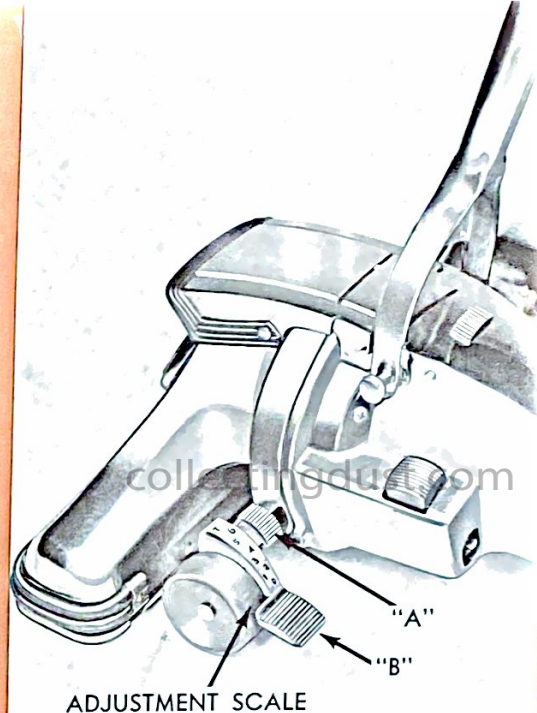

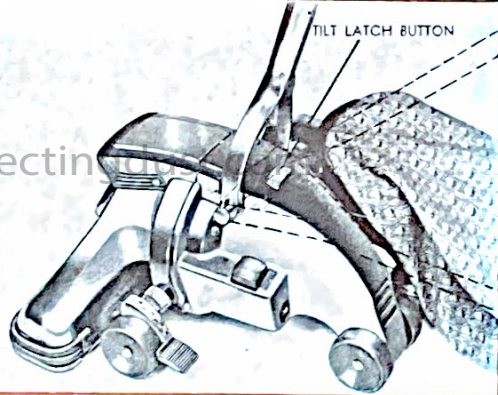

TILT LATCH BUTTON

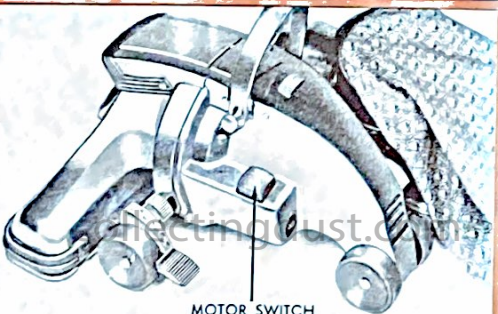

MOTOR SWITCH

TILT LATCH, HANDLE LOCK AND MOTOR SWITCH

TILT LATCH

This latch permits the long handle to swing in an arc to a point where additional downward pressure raises the Rug Nozzle up and over the edge of rugs, electric cords and other obstructions. This action is accomplished by sliding the Tilt Latch button toward the motor switch side of the machine as far as it will go.

When it is necessary to push the Kirby under low furniture, the handle can be brought to a horizontal position simply by sliding the Tilt Latch button to the extreme opposite position — toward the bag or Sani Em-Tor.

HANDLE LOCK

To lock the handle in the horizontal position for the cleaning of stair treads, etc., simply push the Tilt Latch button towards the switch side of the machine while the handle is in the horizontal position. It may be necessary to maintain pressure on the button as you gradually raise the handle.

MOTOR SWITCH

The Kirby motor is turned on or off by depressing the switch button on the side of the motor unit with either your toe or hand.

You will notice that the motor will not turn on or off until pressure on the button is released.

HOW TO USE THE Sani Em-Tor

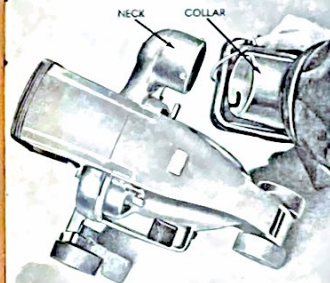

ATTACHING THE SANI EM-TOR

The Sani Em-Tor is attached to the neck of the Motor Unit with a simple twist. Detailed instructions can be found on page 17. Before putting unit into operation, be sure plastic bottom is locked securely in place.

The Sani Em-Tor, with the patented Sani-Pocket, is an exclusive Kirby device which enables you to empty the bag right in your home without muss, fuss or expense.

The Sani Em-Tor should be emptied after each thorough cleaning. If dirt is allowed to accumulate in the filter bag, the cleaning efficiency of your Kirby will be reduced. It is just good housekeeping to keep the Sani Em-Tor and filter bag empty.

EMPTYING THE FILTER BAG

1. Detach bag chain from handle clip.
2. Lower Rug Nozzle to No. 0 position (See page 9) and turn on motor.
3. Allow motor to run briefly and then turn off. While bag is still extended, shake it vigorously from the top.
4. Spread newspaper on the floor and place Kirby on it.
5. Tilt machine slightly and lift lock lever on the side of Sani Em-Tor to release plastic bottom.
6. Swing bottom tray out from under Sani Em-Tor and turn it upside-down, emptying the dirt and lint onto the paper.
7. After all dirt has been removed, swing plastic bottom back into place and lock securely with locking lever.

If excessive dirt and lint has accumulated in the bag, and does not fall readily into the Sani Em-Tor, use the following procedure:

1. Open zipper at rear of bag and place hand into patented Sani-Pocket, grasping Sani-Scraper at bottom.
2. Scrape sides of bag with Sani-Scraper in downward strokes.
3. Using Sani-Scraper, push excess lint and dirt into Sani Em-Tor.
4. Empty as in "5" through "7" above.



ATTACHMENT INSTRUCTIONS

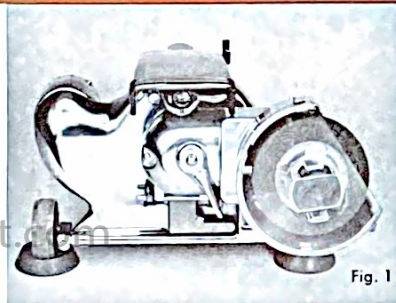

On the front of your Handi-Butler you will find a lever which can be rotated between "ON" and "OFF" positions. This is the Belt Lifter for the Handi-Butler.

STEP 1: Set the lever in the "ON" position and by looking through the round opening at the back make sure the belt is over the metal finger. If it is not in place, use a lever such as a screwdriver to slip the belt over the finger.

HANDI-BUTLER

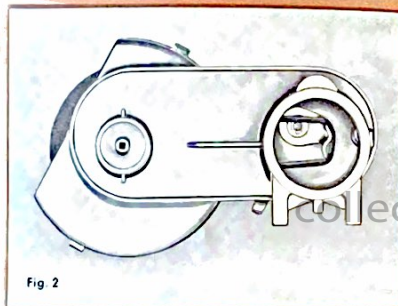

STEP 2: Turn the Belt Lifter lever to the "OFF" position thus extending the belt (figure 2). The unit is now ready for attachment to the Motor Unit.

STEP 3: Raise the Floodlight Hood. Hold the Handi-Butler so the Attaching Slot is on the Attaching Bar which is just below the Belt Drive Shaft. (Figure 3). The Belt Drive Shaft should enter the large round opening and pass through the loop formed by the belt.

HANDI-BUTLER

Continued



STEP 4: The unit should then be swung back against the Motor Unit and at the same time a slight downward pressure should be applied to bring the other Attaching Slot into position on the Attaching Bar.

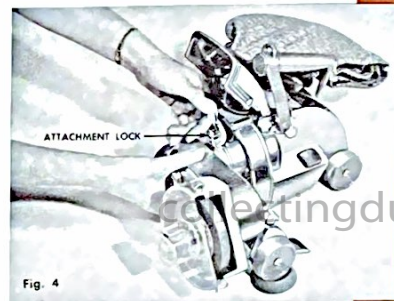

While holding the unit in place, turn the Attachment Lock Lever to hold the unit in place (figure 4).

STEP 5: Turn the Belt Lifter Lever to the "ON" position and the unit is ready for operation. Rubber cups, which are provided, should be placed under the front wheels to steady the unit (figure 3).

HOW TO USE THE HANDI-BUTLER

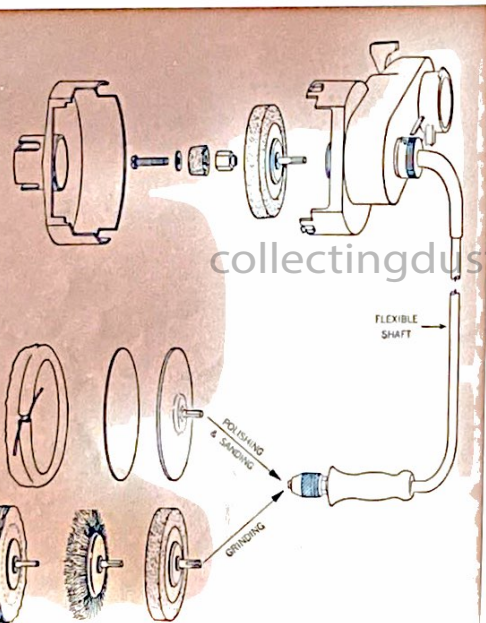

THE ASSEMBLY OF WORK WHEELS

The grinding wheel, wire brush and buffing wheels may be attached to either the Handi-Butler itself, or the flexible shaft. The sanding disk and lambswool pad will attach to the flexible shaft only. To attach to the Handi-Butler, grasp the wheel by the finger grip and insert the wheel shaft into the drive shaft opening. The magnetic clutch will hold the wheel firmly in place. To remove, grasp the wheel by the finger grip and pull firmly away from the drive shaft. To attach to the flexible shaft, attach the drill chuck to the end of the flexible shaft. Insert the wheel shaft into the chuck and tighten. The drawings on the right show typical assemblies and, in the case of the work wheels, the same sequence is followed with each.

ATTACHMENT OF FLEXIBLE SHAFT

To attach the Flexible Shaft, grasp the knurled collar of the bayonet connection and insert the core wire into the small hole at the rear of the Handi-Butler housing. Align the slots in the collar with the pins on the housing and with a firm forward pressure, twist to the right. When released the connection will lock firmly in place. A slight rotation of the Handi-Butler drive shaft may be needed to permit the core wire to engage with the drive shaft.

Caution should be taken to be sure the hand grip of the shaft is held in the hand whenever the power is on.

WHEEL GUARD COVER

The Wheel Guard Cover is attached to the Handi-Butler housing by sliding its edge under the spring clips on the housing. Use this cover for your protection whenever using the work wheels or the Handi-Sharpener. The guard may also be removed from the housing, rotated 180° and re-attached. This provides maximum protection from the grinding wheel while the Handi-Butler is in use as a shoulder portable unit or as a knife sharpener. See use of the Handi-Sharpener on page 15. Abuse of this cover can result in breakage which is not covered by the warranty.

POLISHING AND BUFFING

The lambswool polishing pad is stretched over the rubber disk and fastened by drawing the strings tight and tying. Be sure to tuck the loose ends under the edge of the pad. It is not necessary to have the sandpaper disk in place as the drawing, left, might imply. This pad is ideal for polishing waxed surfaces such as your table tops.

Your buffing wheels can help you restore the luster to your silverware or other decorative metal objects around your home. The sheeting buffing wheel is used with the red polishing compound No. 1 to polish brass, copper, or similar metals. The flannel buffing wheel is used with the light-colored polishing compound No. 2 to polish precious metals such as gold or silver. The polishing compounds are applied by holding the stick against the rotating wheel.

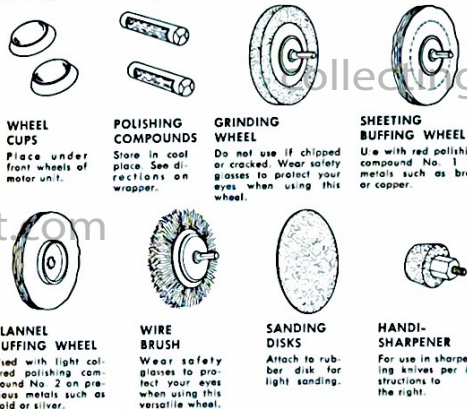

WHEEL CUPS

Place under front wheels of motor unit.

POLISHING COMPOUNDS

Store in cool place. See directions on wrapper.

GRINDING WHEEL

Do not use if chipped or cracked. Wear safety glasses to protect your eyes when using this wheel.

SHEETING BUFFING WHEEL

Use with red polishing compound No. 1 on metals such as brass or copper.



FLANNEL BUFFING WHEEL

Used with light colored polishing compound No. 2 on precious metals such as gold or silver.



WIRE BRUSH

Wear safety glasses to protect your eyes when using this versatile wheel.



SANDING DISKS

Attach to rubber disk for light sanding.



HANDI-SHARPENER

For use in sharpening knives per instructions to the right.

HOW TO USE THE HANDI-SHARPENER & "MAGIC FINGER" BELT-LIFTER

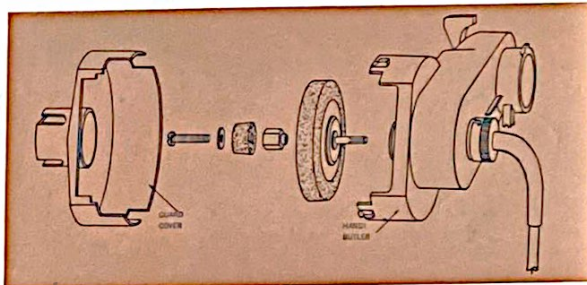

HANDI-SHARPENER

Your Handi-Sharpener is assembled and ready to use when you receive it. If it becomes necessary to replace the knife sharpening wheel, the above diagram shows the assembly sequence. Replacement wheels can be obtained from your Kirby Dealer.

The preferred method of sharpening a knife is as follows: Remove the plastic wheel guard, rotate 180° and replace. The rim of the plastic wheel guard will cover the large grinding wheel and eliminate the possibility of accidental contact. Hold the knife to be sharpened in your right hand, using the left hand to assist in steadying the knife handle. Insert the knife blade at the handle end into the top slot and guide it back and forth, keeping the edge of the blade against the grinding wheel. Now sharpen the other side of the knife by inserting the blade into the bottom slot and repeating the operation.

ASSEMBLY INSTRUCTIONS

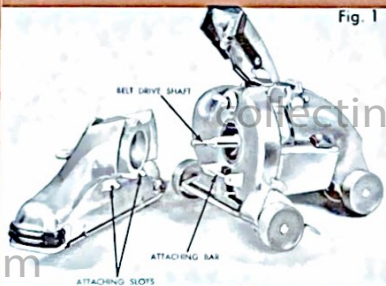

UPRIGHT CLEANER

The following units should be attached to the Motor Unit for use as an upright rug cleaner: Rug Nozzle, Long Handle, Sani Em-Tor and Bag.

ATTACHMENT OF RUG NOZZLE

- STEP 1:** Set Belt Lifter on Rug Nozzle for attachment as explained on page 8.
- STEP 2:** Set Toe Touch Nozzle Adjustment at No. 7 position on Adjustment Scale (See instructions on page 9). Raise Floodlight Hood.
- STEP 3:** Place Attaching Slots at back of Rug Nozzle on the Attaching Bar. (see figures 1 and 2). Swing nozzle back toward Motor Unit with a slight downward pressure so as to depress the Safety Switch Slide (see figure 2). Hold nozzle in place with one hand and lock in place with Attachment Lock Lever at top-front of Motor Unit. (see figure 3).
- STEP 4:** Turn Belt Lifter to "ON" position (figure 4).
- To remove nozzle reverse these steps. Be sure to have Belt Lifter in "OFF" position before releasing attachment lock lever. (See figure 3).

ATTACHMENT OF LONG HANDLE

- STEP 1:** Remove Handle Pin from Motor Unit by pulling straight out with a slight twisting action.
- STEP 2:** Insert the fork of the Long Handle into the slide at top of Motor Unit (see figure 5).
- STEP 3:** Replace Handle Pin as far as it will go.

16

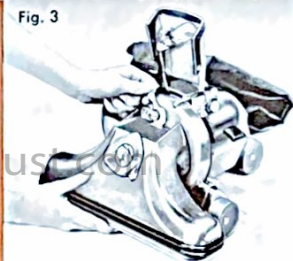

ATTACHMENT OF SANI EM-TOR

- STEP 1:** On the inside of the Sani Em-Tor collar you will notice three curved slots. These should be lined up with the pins on the neck of the Motor Unit.
- STEP 2:** Slide the collar firmly over the neck and twist downward. The unit will lock firmly in place. (See Figure 6)
- When the unit is new the rubber gasket inside the collar of the Sani Em-Tor will be stiff and offer some resistance. This gasket is necessary to give you an air-tight seal.
- To remove the Sani Em-Tor simply twist from the bottom and away from the Motor Unit. It will unlock with a snap.

SUCTION RELIEF VENT

Turn vent plate clockwise to open. When open, it is easier to clean efficiently long pile cotton or synthetic carpets and light weight throw rugs. Vent should be closed for normal, full power cleaning operations, and when emptying bag. See page 6 for location.

ATTACHMENT OF FILTER BAG AND CORD

Plug the cord into the rear of the Motor Unit just below the Motor Switch. Fasten the cord hook to the clip just below the Handle Grip and wind down under the lower cord hook and up over the Swiveled Cord Hook. (Figure 7)

Fasten the bag chain to the other side of the double clip.

17

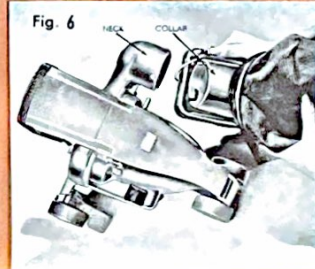
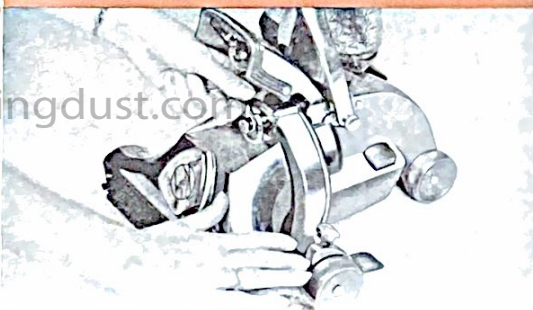
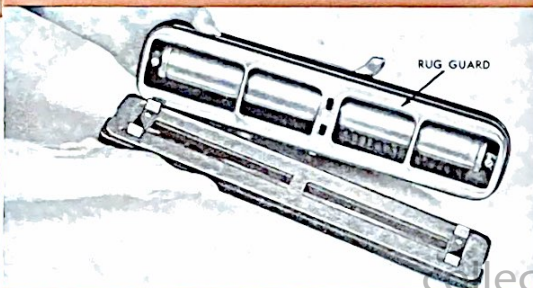

Fig. 7



HOW TO USE



THE DUSTER-BUFFER

With the Kirby assembled as an upright rug cleaner, snap the Floor Duster Pad into place by inserting the spring clips into the rug guard on the bottom of the Rug Nozzle. Set the Toe Touch Nozzle Adjustment on the "O" position (see Page 9), turn the Belt Lifter to the "OFF" position (see Page 8), turn on the motor, and you are ready to buff-dust hard surfaced floors.

If floor is littered with sand or coarse dirt, adjust nozzle so pad just clears the floor for the first cleaning operation.

POWER POLISHER

Assemble the Kirby as an upright machine (See Pages 16 & 17) with the exception of the Rug Nozzle. In its place attach the Power Polisher Nozzle. Attachment procedure is the same as for the Rug Nozzle (See Page 16).

Apply wax to the surface to be protected. Polishing can be done immediately after applying Kirby Wax — no drying time is required for Kirby Wax — as other waxes may require. Set the Toe Touch Nozzle Adjustment to the lowest or "0" position (See Page 9) so the front wheels do not touch the floor. Set handle in normal cleaning position. Turn on the motor and the Polisher Brush will quickly polish your waxed floor to the highest possible luster. The best polishing results will be obtained when the polisher is resting on the rear wheels and the polisher brush.

By pushing the handle down against the Tilt Latch (See Page 10) it is possible to raise the brush and easily polish a six inch baseboard.

When storing the Power Polisher Nozzle, be sure to turn the Belt Lifter to the "ON" position. If you don't, the belt will become stretched and useless.

HOW TO USE

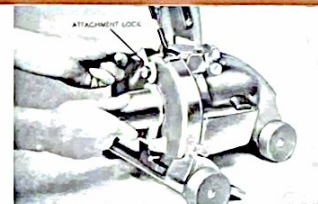

THE BASIC ATTACHMENTS

THE SUCTION COUPLER

Place the Attaching Slots of the Suction Coupler over the Attaching Bar at the front of the Motor Unit. Swing the coupler back against the Motor Unit and lock in place with the Attachment Lock Lever. To do this a slight downward pressure should be applied so as to depress the Safety Switch Slide.



THE BLOWER COUPLER

The coupler is attached by placing it over the neck of the motor unit and pushing it into place with a clockwise twist. It will lock into position.

THE PORTABLE HANDLE AND SHOULDER STRAP

Remove Handle Pin and Long Handle. Slide legs of portable handle into place on top of the Motor Unit as illustrated. Replace Handle Pin. The Shoulder Strap is hooked to the loops provided at top and rear of handle.

THE FLEXIBLE HOSE

May be connected to Suction Coupler for cleaning or to the Blower Coupler for spraying or demisting. In either case grasp the Hose Locking Nut firmly, slide over the coupler opening on Motor Unit and lock in place with a clockwise twist.

BAG ATTACHMENT FOR PORTABLE UNITS

Sani Em-Tor and bag are attached as explained on page 17. Bag is then folded under and bag chain hooked to the clip at the back of Portable Handle.

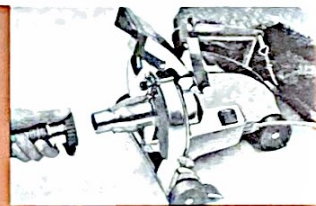

HOW TO USE

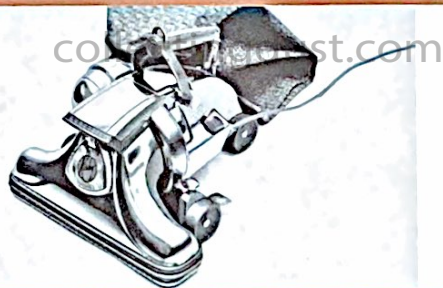

THE PORTABLE UNITS

HAND PORTABLE

Here is a powerful unit which will do a magnificent job of cleaning your deep cushions and stair treads. It is especially suited for use on your mattress.

To assemble, attach the following to the Motor Unit: Rug Nozzle (See Page 16). The Portable Handle (Page 19). The Sani Em-Tor (Page 17). Hook the Bag Chain to the clip on the Portable Handle and with the Toe Touch Nozzle Adjustment (Page 9) set the nozzle height at the position most suitable.



SHOULDER PORTABLE

This unit is ideal for cleaning large areas where considerable mobility and freedom of hands are advantages. It is also convenient to use with the Handi-Butler and Flexible Shaft. To assemble, attach the following to the Motor unit: Suction Coupler and Flexible Hose, or Handi-Butler and Flexible Shaft (See Page 19 or 12, 13 & 14), Sani Em-Tor and filter bag (Page 17), and the Portable Handle and Shoulder Strap (Page 19).

FLOOR PORTABLE OR TANK TYPE CLEANER WITH SURFACE NOZZLE

This is a unit which gives you the light-weight portability of a tank-type machine for above-the-floor cleaning operations around your home. Use with various combinations of the tools and extension tubes, you can clean those hard-to-reach areas in your home with ease. To assemble, the following should be attached to the Motor Unit: Sani Em-Tor and bag, Suction Coupler, Flexible Hose, and appropriate extension tubes and tools. For complete portability, remove the Long Handle and replace it with the Portable Handle. Extension tubes and tools are connected simply by inserting the tapered end of the hose or tube into the tool with a firm twist. To release simply twist and pull. A straight pull will not separate the parts if they have been properly assembled.

THE SURFACE NOZZLE

This nozzle has been designed to facilitate the surface cleaning of carpets and hard surfaced floors under your low furniture, and for dusting of all hard surfaced floors. It will not deep clean your carpets, as will the Kirby Floor Nozzle with Triple Cushion Vibration. However, it will do as good a job as any straight suction nozzle available.

For cleaning carpets, flip brush adjustment lever on front of nozzle to left, so word "UP" appears on lever. This raises the brush to the proper height for carpets. For cleaning hard surfaced floors, flip the lever to the right, so word "DOWN" appears on the lever, thus adjusting the brush to the proper height for bare floors. The following is a listing of recommended lever settings for the various types of cleaning you may encounter with your Kirby surface nozzle:

UP	DOWN
Bare floors — dust only	Bare floors — imbedded dirt
Deep pile rugs	Bare floors — lint and fuzz
Cotton loop rugs	Short pile rugs



THE CRYSTALATOR

To assemble, attach the Suction and Blower Couplers to the Motor Unit. The Flexible Hose may or may not need to be attached to the Blower Coupler depending on the intended use. Fill the Crystalator with 1 aradichlorobenzine Crystals (Moth Crystals) and attach to the Suction Coupler.

FILLING THE CRYSTALATOR

Turn the cap so the "ON-OFF" marker lines up with the arrow on the sirocco body of the Crystalator and lift off. Pour in crystals until the Crystalator is about half full when held in a horizontal position. A finger inserted into the inner cone will close the slot and prevent spillage. Replace cap and turn to desired setting: "Gas" for de-mothing a closet or other confined area; "Medium Crystals" for furniture, baseboards, carpets, etc.; "Full Crystals" when it is desirable to deposit large crystals in chests or storage boxes.

ATTACHING THE CRYSTALATOR

Inside the neck of the Crystalator you will find a small lug. This must be lined up with the slot in the neck of the Suction Coupler as the Crystalator is pushed firmly into place.

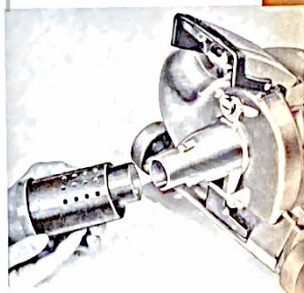

USE WITH HOSE

Assemble the Crystalator Unit as described on the preceding page and also attach the hose and the crevice tool to the blower coupler. See illustration at the right. The crevice tool brush should be removed by squeezing the wire together at the point where it enters the tool and pulling straight out.

DEMOTHING A CLOSET

Assemble the Crystalator Unit as described above and, without attaching the hose, place the unit on the floor of your closet. Turn the Crystalator cap to the "Gas" position, turn on the motor, and close the door. It is advisable to seal the crack at the floor with a throw rug. Allow the motor to run for from 5 to 15 minutes, depending on the size of the closet.

If Crystals are damp they will tend to cling together and stop the action of the Crystalator. If this happens, just place your hand over the holes in the top of the Crystalator body for a second while the motor is running. This will loosen the crystals and start them flowing into the fan chamber where they are exploded into a moth-killing gas.



HOW TO USE

THE SPRAY GUN, SUDS-O-GUN



THE SPRAY GUN

Assemble the Floor Portable or Shoulder Portable unit as instructed on Pages 20 and 21, except that the Blower Coupler and Flexible Hose are connected to the neck of the Motor Unit in place of the Sani Em-Tor. The Spray Gun is attached to the hose with a firm twist.

Paints should be thinned for spray application as instructed on the can. To fill the Spray Gun jar, unscrew from unit and fill about three-fourths full. Avoid over-filling to prevent spillage in use. An extension tube is provided inside the supply tube which can be extended for larger jars. Screw jar back in place firmly.

Turn on motor and adjust to proper spray. Turning the button at the rear of the gun clockwise makes the spray finer. Pull trigger with index finger to spray.

After use, be sure to clean gun by spraying a solvent through the gun. Wipe off exposed surfaces.



THE SUDS-O-GUN

Assemble Spray Gun as explained, left, and place Suds-O-Gun cap over the front of spray gun — a clockwise twist will do it.

Mix Kirby Instant Suds as directed on bottle, and fill jar about three-fourths full. Adjust gun to a *very fine* spray. A volume of very dry suds will then be produced. Suds can be spread directly on surface to be cleaned or gathered in a basin.

The suds should be worked into the surface with a brush or sponge until they disappear. Allow a few minutes for surface to dry thoroughly and vacuum with appropriate nozzle to remove the dry froth which now contains the grime and dirt.

collectingdust.com

HOW TO MAINTAIN AND SERVICE YOUR



Important:

Your Kirby will give you many years of trouble-free service if you will care for and maintain it according to the suggestions made on the next few pages.

On the following page we have attempted to cover the various situations which might occur and which can be corrected easily by you at home without the inconvenience of having to contact a serviceman even though he is ready to help you at any time. If you are experiencing a difficulty, read over the various sections in this book pertaining to the problem and take the action indicated before you call a serviceman.

The Kirby Distributor in your area stands ready to be of assistance to you at all times and his address should be put on the cover of this book for your future reference. If, at any time, you have need of the address of your closest service representative, you are welcome to contact the factory.

HELPFUL HOME SERVICE HINTS

If Kirby will not pick up lint or ravelings on carpet, check to see if

1. Belt Lifter is in "OFF" position (Page 8)
2. Belt is broken or worn out (Page 28)
3. Brush needs adjustment (Page 27)
4. Toe Touch Nozzle Adjustment is improperly adjusted (Page 9)
5. Filter bag needs emptying (Page 11)
6. Brush needs cleaning (Page 27)

If motor will not run but floodlight lights up

1. Make sure either the rug nozzle, suction coupler, Handi-Butler or Power Polisher is properly in place.

If motor will not run and light does not light

1. Check to make sure cord is properly plugged into the machine and wall outlet.
2. Make sure there are no breaks in cord. Check by attaching to a floor lamp and flexing back and forth along entire length of cord. Pay particular attention to male and female connectors at ends of cord.

If Rug Nozzle is loose even after proper attachment

1. Attachment lock not turned tight enough.

If Sani Em-Tor (Dirt Trap) is loose

1. Check to be sure it is locked in position by turning clockwise as far as possible. (Page 17)

2. Check to see if rubber gasket inside collar of Sani Em-Tor is properly in place. If not, call for service.

If Power Polisher Brush will not revolve

1. Make sure Belt Lifter is in "ON" position.
2. Check condition of belt — replace if necessary. (See Page 28)
3. Make sure belt is not wet with wax.

If Handi-Butler work wheels will not revolve or stop under light pressure

1. Make sure Belt Lifter is in "ON" position.
2. Check belt and replace if broken, worn or stretched. (See Page 28)

If motor runs but light does not light

1. Check bulb for tight fit.
2. Bulb burned out — replacement needed.

If dirt will not fall out of bag and Sani Em-Tor

1. Too much dirt has been allowed to accumulate and it is jamming the large opening of the Sani Em-Tor where the bag is attached. Use Sani-Scraper in Sani-Pocket to clean bag and force dirt into Sani Em-Tor.

If Kirby is hard to push when Rug Nozzle is attached

1. Toe Touch Nozzle Adjustment set too low. Raise one or two notches. (Page 9)

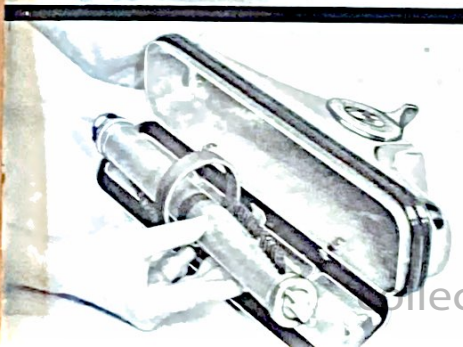

BRUSH ADJUSTMENT AND CLEANING

Through usage, the revolving brush in the rug nozzle will gradually wear down. When it fails to protrude approximately 1/16 inch beyond the stainless steel rug guard — check by laying a flat piece of stiff cardboard across a portion of the rug guard — turn the brush roll adjustment screws at each end of the brush roll clockwise with a screw driver until the proper amount of bristle protrudes. Be sure to turn each screw an equal amount so the same amount of bristle protrudes on each end of the brush roll.

TO REMOVE BRUSH ROLL FROM RUG NOZZLE

1. Remove nozzle from motor unit.
2. Turn Belt Lifter to "ON" position.
3. Swing Rug Guard from nozzle on hinges as pictured.
4. Spread support brackets by bending slightly away from Brush Roll. The brush may then be removed for cleaning.
5. Use scissors to cut string, thread or hair which may be wrapped around the brush roll. An old comb is also useful in removing foreign matter embedded in brush tufts.

REPLACEMENT OF BRUSH ROLL

1. Place ends of Brush Roll into support brackets — one end is wider than the other so it can be replaced only the correct way.
2. Bend the support brackets back into place.
3. Make sure belt is positioned in center of Brush Roll.
4. Swing Rug Guard back into the nozzle — it will snap into place. It will be necessary to depress the belt slightly as this is done.



KIRBY WAX

Kirby Emulsion-Type paste wax is especially designed for use with your Kirby Power Polisher. This completely new concept in floor wax gives you all the qualities of a hard, long lasting, slip-resistant wax plus a proven germ-fighting additive that cannot be incorporated in any mineral spirit, kerosene, or turpentine type of wax.

The Kirby Handi-Waxer is designed to fit your Kirby extension tubes, and provides a wide-swath applicator in a convenient size package. A plastic cover of inert and flexible material prevents the wax from drying out when not in use. Each waxer contains a 1/2 pound package of Kirby Emulsion Wax.

To use the waxer, slit the wax pouch with a sharp knife through the slot in the felt bottom face. The wax will feed into the felt when pressure is applied on the extension tube. Convenient step pads are provided on the waxer to enable you to increase the pressure on the wax if normal applying pressure from the extension tubes is not sufficient.

Kirby Emulsion Type Wax is ideal for use with your Kirby Power Polisher, and can be polished immediately after application. It is safe to use on any type of linoleum, asphalt tile, vinyl tile, rubber tile, cork tile or wood floor. Refill packages containing two half pound pouches are obtainable from your Kirby dealer.



KIRBY INSTANT SUDS WITH KGF-40

Now you can clean carpets, upholstered furniture and other household articles with volumes of extra dry suds and help to make them safe against air and dust borne bacteria. Set up the Kirby for spray gun operation and mix 3 caps full of this Kirby Instant suds with 3/4 jar full of luke warm water. Attach the Suds-O-Gun screen to the front of the spray gun. Using a fine setting of the adjustment screw you can make a tremendous volume of suds from a small amount of liquid. Direct the suds into a bowl or over a small area of the surface to be cleaned and brush suds into the surface until the suds disappear. After drying, remove the residue (which now contains the dirt) by vacuuming with your Kirby. Kirby Instant Suds comes in an unbreakable 12 ounce plastic bottle and full directions are included on the label. This combination of cleaning power, resoiling resistance, mildew prevention, fabric brightener and germ-fighting action makes Kirby Instant Suds with KGF-40 unique.

KGF-40 CONCENTRATE

Here at last is a means of fighting infectious air borne bacteria in your home. Kirby KGF-40 concentrate enables you to do this simply and effectively. Set up your Kirby for spray gun operation. Mix 3 caps full of KGF-40 concentrate into 3/4 of a spray gun jar full of water. Remove Suds-O-Gun nozzle. Adjust the valve opening on the spray gun by means of the adjusting screw located in the rear of the handle so that a fine mist is obtained. Lightly spray floors, rugs or other surfaces upon which dust or air borne bacteria might settle. KGF-40 may also be effectively applied to your Kirby Filter Bag, furnace or air conditioning filters. KGF-40 concentrate is available in a 12 ounce unbreakable plastic bottle from your Kirby dealer, and will make nearly 2 gallons of effective spray. Rinse the gun and jar with clean water after use. Will not harm any surface not harmed by water alone.

INDEX

	Pages
Attachments	4, 6, 7, 19, 20
Attachment Lock	6, 16
Bag	11, 17, 19, 29
Bag Guard	29
Belt Lifter	8, 12, 13
Belt Replacement	28
Blower Coupler	19
Brush Adjustment	27
Brush Cleaning	27
Brush Roll	27, 28
Buffing Wheels	15
Bulb Replacement	29
Cord	17, 29
Crystalator	2, 22, 23
De-Mothing Unit	2, 22, 23
Dirt Trap	5, 11, 17
Electric Floor Duster	4, 18
Emptying the Bag	11
Extension Tubes	21
Flexible Hose	19
Flexible Shaft	14, 15
Floodlight Replacement	29
Floor Duster	4, 18
Floor Polisher	3, 18
Floor Portable	3, 21
Grinding Wheel	14, 15
Guarantee	32, 33

	Pages
Hand Portable	3, 20
Handi-Butler	2, 12, 13, 14, 15
Handi-Sharpener	15
Handi-Wax	30
KGF-40 Concentrate	30
Handle Lock	10
Handle, Long	16
Handle, Pin	16
Handle, Portable	19
Hose	19
Hose Locking Nut	19
Long Handle	16
Lubrication	29
Maintenance	26
Mattress Cleaner	3, 20
Motor Switch	10
Motor Unit	6, 7
Parts	6, 7, 14, 15
Polishing Compounds	15
Portable Handle	19
Portable Units	20, 21
Power Polisher	3, 18, 28
Power Tool	2, 14, 15
Rug Cleaner	3, 16, 17
Rug Guard	29
Rug Nozzle Attachment	16, 17

	Pages
Rug Nozzle Adjustment	9
Safety Switch	5
Sanding Disks	14, 15
Sani Em-Tor	5, 11, 17
Sani-Pocket	5, 11
Service	26
Shampoo	30
Shoulder Portable	4, 20
Shoulder Strap	19
Spray Gun	2, 24
Suction Coupler	19
Suction Relief Vent	6, 17
Suds-O-Gun	2, 24
Surface Nozzle	21
Switch, Safety	5
Switch, Motor	6, 10
Swivel Nozzle	21
Swiveled Cord Hook	5, 29
Tank-Type Unit	3, 4, 21
Tilt Latch	10
Toe Touch Nozzle Adjustment	9
Tool Cabinet	4
Upright Cleaner	3, 16, 17
Wands	21
Wheel Cups	15
Wire Brush Wheel	15

KIRBY GENERAL COVERAGE WARRANTY

KEEP THIS BOOK AT ALL TIMES

This Warranty, General Service Insurance, and Coverage of Loss by Fire are null and void if the name plate or serial number have been intentionally defaced, removed, or changed.

Subject to the conditions and exceptions herein stated, The Scott & Fetzer Company, herein called the "Company", warrants this Kirby product to be free from defects in material and workmanship under normal use and service.

At any time within one year from the date of delivery to the original purchaser, the Company will furnish for this Kirby product, a replacement part or repair material for any part found by the manufacturer to be defective. Such replacement part and repair material will be furnished without cost to the owner or user through an authorized Kirby service center or f.o.b. its factory at the Company's election.

There are no warranties by the Company which extend beyond the statements and description on the face hereof, and this Warranty is expressly in lieu of all other Warranties expressed, or implied, and of all other obligations or liabilities, on its part, and it neither assumes nor authorizes any other person to assume for it liability in connection with the sale of its products.

This Warranty does not apply to belts or to light bulbs or to damage caused by accident, misuse, negligence, abuse, or to any Kirby products which have been repaired or altered outside of a Kirby authorized service center in any way so as in the judgment of the Company to effect its stability or reliability, or in which parts not made by, sold by, or approved by The Scott & Fetzer Company shall have been used.

GENERAL SERVICE INSURANCE

Subject to the condition set forth in Section A above, and further condition that the Kirby described herein has been originally purchased from an authorized Kirby Distributor, Area Distributor, or Dealer, the Company and/or Distributor and/or Area Distributor, hereby agree with the original purchaser to entirely rebuild and recondition such Kirby any time after the expiration of the factory guarantee and as often as he may require, providing it is still the property of and in the possession of the original owner, as set forth in the following:

1. The Company, in rebuilding the machine for the purchaser will make every effort to keep the cost to the customer for this service as low as possible and the Company will in no case charge the customer more than \$22.50 for any one rebuild.

2. The Company's price of \$22.50 shall include all labor and cost of parts necessary to put the machine in A-1 condition. Transportation charges and replacement cost of broken or missing parts are, of course, extra charges.
3. If a Kirby owner should desire to have an authorized Kirby Distributor or Area Distributor do the rebuilding as outlined above, such Distributor or Area Distributor (to compensate for transportation charges that he must pay on genuine Kirby parts), may charge up to but not in excess of \$27.50 for any one rebuilding. It is to be noted that the Distributor's rebuilding charge in most cases represents a substantial saving to the Kirby owner as compared to the factory rebuilding charge plus transportation. Also, local Distributors can generally save considerable time in the rebuilding process.

KIRBY GENERAL COVERAGE WARRANTY

KEEP THIS BOOK AT ALL TIMES

COVERAGE OF LOSS BY FIRE

Subject to the condition set forth in Section 3 above and further subject to the condition that his Kirby has been originally purchased from an authorized Kirby Distributor, Area Distributor, or Dealer, the Company agrees:

1. In the event that this Kirby, while owned by and in the possession of the original purchaser should be damaged by fire on the premises of such purchaser, the Company will repair or rebuild the Kirby for the customer and return the equivalent of a new Kirby of the same model providing the customer will send \$22.50 and the fire damaged remains prepaid to our factory within 90 days after date of the damaging fire. If cleaning tools also need replacing by reason of fire damage, an additional charge of \$8.00 will be made. Return transportation to the customer's home will be paid by the customer. If the Kirby Power Polisher, Handi-Butler or Flexible Shaft are damaged or destroyed by fire, The Scott & Fetzer Company will replace Kirby Power Polishers at a cost of \$7.00 each to the customer, Kirby Handi-Butlers at a cost of \$8.00 each, Flexible Shaft at a cost of \$5.00 each, all F.O.B. Cleveland, Ohio. This service is based solely upon the condition that the customer has met with all the requirements of the purchase agreement, and it is distinctly understood that said replacement will in no way nullify or modify the terms of that purchase agreement.

2. In the event that the Kirby, Cleaning Tools, Power Polisher, Handi-Butler or Flexible Shaft, while in the possession of the original purchaser shall be completely and wholly destroyed by fire so that no damage parts can be returned, an affidavit sworn to by the original

owner before a notary public will be accepted within 90 days after date of the damaging fire in lieu of damaged parts and the Kirby and/or attachments will be completely replaced under the terms set forth in Section 1 above.

THE SCOTT & FETZER COMPANY
Manufacturers of the
Kirby Sanitronic System
JOHN A. KEMPER, *President*

At any time within one year from the date of delivery of this Kirby product to the original purchaser, it is the responsibility of the authorized Kirby Distributor, Area Distributor, or Dealer, making the sale, subject to the conditions and limitations outlined in connection with the above warranty, to repair and/or provide for the labor necessary to replace any part or parts of the Kirby product furnished by the Company under the above warranty provisions or provide such repair or parts replacement through other competent service sources at no cost to the owner. Service calls during the one year warranty period, other than those covered by the conditions expressed herein, will be at the expense of the owner.

PLEASE COMPLETE THE FOLLOWING

The above Warranty Covers Kirby Model 562.

(Serial No.)

Date of Delivery

Authorized Dealer Signature

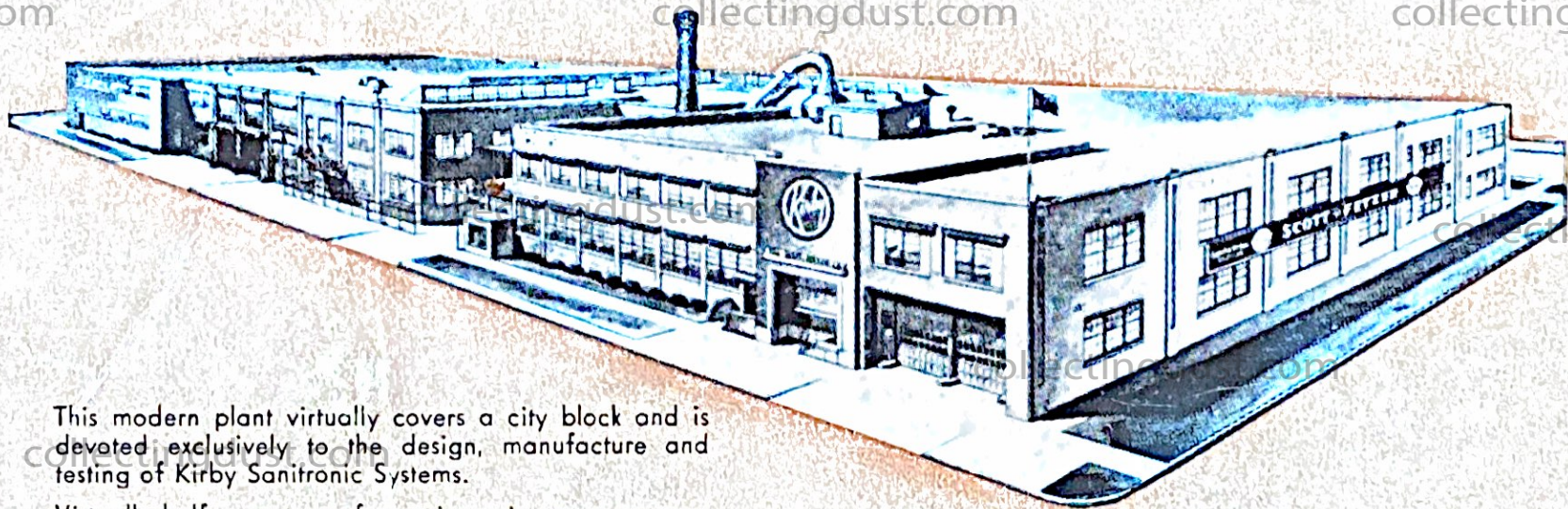

This modern plant virtually covers a city block and is devoted exclusively to the design, manufacture and testing of Kirby Sanitronic Systems.

Virtually half a century of experience is your assurance of dependability.



the scott & fetzer company

1920 WEST 114TH STREET
CLEVELAND 2, OHIO

Printed in U.S.A.