



DEMOTHER

MAID

HANDY MAN

PAIN

PAINTER

CLEANING WOMAN



# GUARANTEE AND INSTRUCTION BOOK

*Model 518*

**KIRBY HOME SANITATION SYSTEM (A)**

collectingdust.com

collectingdust.com

collectingdust.com

collectingdust.com

collectingdust.com

collectingdust.com

collectingdust.com

collectingdust.com

collectingdust.com

HOME OF *Kirby* collectingdust.com

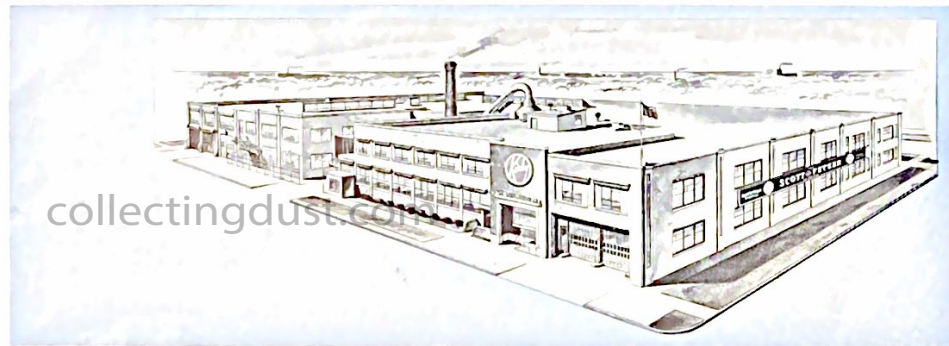

This modern plant covers a city block and is devoted exclusively to the design, manufacture and testing of Kirby Home Sanitation Systems.

# Contents

This book is dedicated to you, the owner of the wonderful new Kirby, and it is designed to promote your complete enjoyment of the Kirby Home Sanitation System. Study the pages carefully and you will learn how your Kirby can truly be a dependable household friend.

|   |               |
|---|---------------|
| YOUR KIRBY .....                                | PAGES 2 - 3   |
| WHAT YOUR KIRBY DOES .....                      | PAGES 4 - 11  |
| HANDI-BUTLER .....                              | PAGE 4        |
| CRYSTALATOR .....                               | PAGE 5        |
| SPRAY GUN & SUDS-O-GUN .....                    | PAGE 6        |
| FLOOR & SHOULDER PORTABLE .....                 | PAGE 7        |
| HAND PORTABLE .....                             | PAGE 8        |
| RUG CLEANER .....                               | PAGE 9        |
| ELECTRIC FLOOR DUSTER .....                     | PAGE 10       |
| FLOOR POLISHER .....                            | PAGE 11       |
| HOW TO USE YOUR KIRBY .....                     | PAGES 12 - 33 |
| HOW TO MAINTAIN AND SERVICE<br>YOUR KIRBY ..... | PAGES 34 - 38 |
| KIRBY GUARANTEE .....                           | PAGES 40 - 41 |
| INDEX .....                                     | PAGE 39       |

You have the finest...

NO OTHER UNIT CAN COMPARE

WITH THE



ngdust.com

IT IS WITH pride that we of The Scott & Fetzer Company welcome you into the ever-growing family of owners of the exclusive Kirby Home Sanitation System. The more you use it . . . the more you will realize that your Kirby is the finest household assistant ever developed for the American housewife. It is actually a maid, a cleaning woman, a handyman, a De-mother, and a painter all in one! For years, the Kirby Home Sanitation System has been first and foremost in its ability to remove efficiently the dust and dirt from the home and its furnishings.

Now, new units, such as the Handi-Butler, Power Polisher, and Suds-O-Gun, extend the range of the Kirby's usefulness into household maintenance. In this booklet we have attempted to show you most of the applications for your Kirby but you will find that as you use the Kirby, a multitude of other uses will become apparent to you.

Keep this booklet handy. Read and review it often, for by knowing your Kirby completely you will not only realize full value from your purchase but you will also begin to appreciate that the Kirby is truly a marvelous invention.

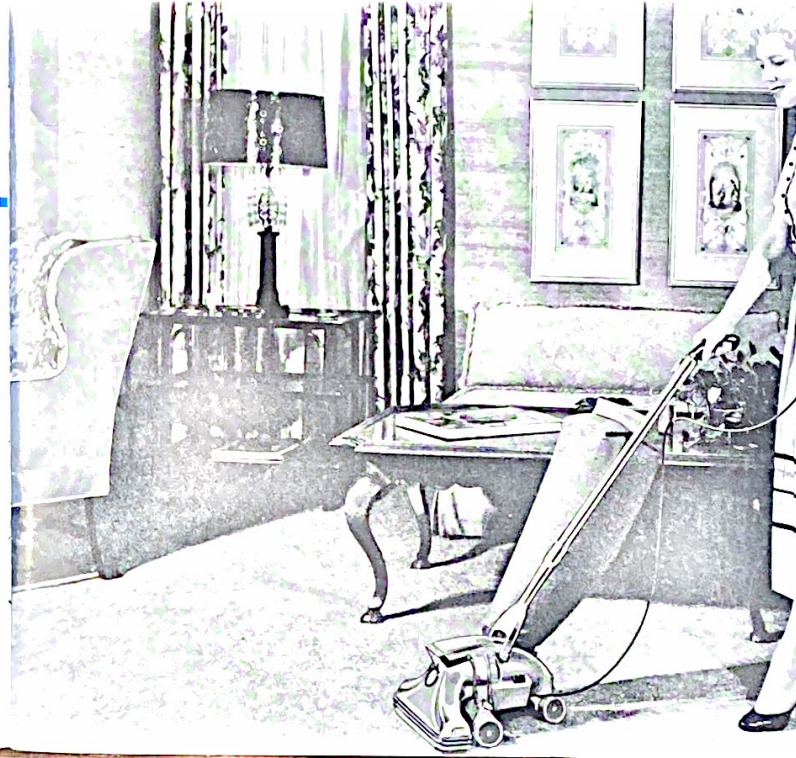

collectingdus

collectingdus



Manufactured by  
**THE SCOTT & FETZER**  
1820 WEST 114th STREET

## Y GUN



range  
er  
anting  
r  
used  
er.

## IT'S A FLOOR PORTABLE OR TANK-TYPE CLEANER



The Kirby Home Sanitation System enables the homemaker to have the advantages of an efficient, upright cleaner for vacuuming rugs and carpets and still be able to easily convert that machine to an efficient tank-type cleaner which is ideal for light dusting and cleaning around the home.

Various combinations of the extension tubes and tools enable you to clean easily hard-to-reach areas of the room as the Kirby power unit follows along on four smooth-rolling wheels.

FOR OPERATION INSTRUCTIONS SEE PAGE 29.

## S A SUDS-O-GUN

A simple conversion of the Kirby Spray Gun enables you to generate volumes of extra-dry suds for the safe and efficient shampooing of rugs, tapestries, and upholstered furniture.

With this unit in your home, it is possible for you to save yourself considerable expense and inconvenience by doing this cleaning operation quickly and easily in your own home. You need never sacrifice the use of your carpets or furniture for more than a couple of hours.

FOR OPERATION INSTRUCTIONS SEE PAGE 32.

6

## IT'S A SHOULDER PORTABLE

By the addition of a shoulder strap, the Kirby floor portable is quickly converted to a shoulder portable unit which makes it possible for you to clean such objects as basement of attic rafters and keep both hands free even though working from a ladder.

FOR OPERATION INSTRUCTIONS SEE PAGE 29.



7

COMPANY

## IT'S A HAND PORTABLE

The Kirby can be converted quickly and easily into a full-powered hand portable unit. Because it is full-powered, it is capable of doing a truly outstanding job on your deep cushions and stair treads. Because of its tremendous power and exceptional portability, this unit also enables you to clean your mattresses thoroughly right on your bed. It is no longer necessary to undergo the extremely difficult task of carrying your mattresses outside for airing, or to give them up for a considerable period of time for professional mattress renovation. You can clean them yourself easily and be fully confident that you have a clean, wholesome mattress on which to sleep.

FOR OPERATION INSTRUCTIONS SEE PAGE 28.

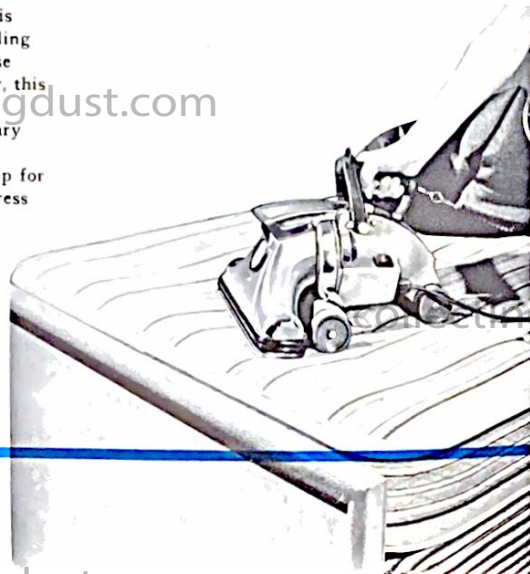

*Mattress Cleaner*

collectingdust.com

## IT'S AN UPRIGHT CLEANER

### RUG CLEANER

The Kirby upright rug cleaner is undoubtedly the most efficient and versatile machine of its kind available. It will clean all types of floor coverings thoroughly because it is easily and positively adjusted to the particular job.

To remove all of the dirt, grit and lint from your floor coverings, it is necessary not only to sweep the surface but also to loosen the deep-down sand and dirt which is locked into the base of the rug fibers. To remove this dirt safely, our engineers developed Kirby's "TRIPLE-CUSHIONED VIBRATION" rug cleaning action.

Here is how it works: First, a plastic cap on each end of the brush roll cushions the brush roll mechanism. Second, long resilient bristles in the revolving brush bend to cushion the sweeping and vibrating action. Third, the rug is lifted from the floor and held firmly against the stainless steel Rug Guard by the strong suction. This enables the brush to vibrate the rug while it is supported on a cushion of air and thereby loosen all the embedded dirt.

In the case of felt floor coverings, such as carpet pads and some types of cotton carpets, use only suction and not the revolving brush. You do this with your Kirby simply by turning the Belt Lifter to the "OFF" position (see page 15). With the belt "OFF", the brush will not revolve.

FOR OPERATION INSTRUCTIONS SEE PAGES 22 & 23

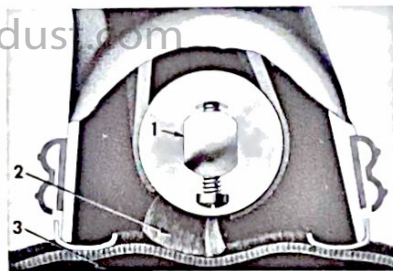

*Triple-Cushioned Vibration*

collectingdust.com

## IT'S AN ELECTRIC FLOOR DUSTER

Simply by attaching the Floor Duster Pad to the upright Kirby and turning the Belt Lifter to the "OFF" position (see page 15) you have an effective means of cleaning hard surfaced floors. The felt pads loosen the dirt and buff the waxed surface while the strong suction removes the dirt from the floor and deposits it in the bag and Sani Em-Tor.

FOR OPERATION INSTRUCTIONS SEE PAGE 26.



### Sani Em-Tor

This is the exclusive Kirby feature which makes it easy for you to empty the bag right in your living room without any muss or fuss.

FOR OPERATION INSTRUCTIONS SEE PAGES 23 & 25.

### Air Refresher

While vacuuming you can also eliminate unpleasant odors from your home. Simply add a few drops of Sweet-Aire to your Air Refresher and the room will be filled with a pleasant, odor-killing pine scent.

FOR OPERATION INSTRUCTIONS SEE PAGE 26.



## Plus Features

### Safety Switch

This is your protection against possible injury. As long as the fan blades are exposed, the safety switch disconnects the motor so that it will not run. Either the Handi-Butler, Floor Nozzle, Power Polisher or Suction Coupler must be attached before the motor will run.



### Swiveled Cord Hook

The cord can be released for use easily by turning the top cord hook in either direction.

## IT'S A POWER POLISHER

This is your floor polishing unit. It is even more efficient and effective than special machines purchased for that purpose. When needed, it can be quickly attached to your Kirby Motor Unit and used to polish any hard surfaced floor after wax has been applied. The high speed cylinder brush quickly gives you a bright finish without streaks. Its exclusive design enables you to polish right up to your baseboards and deep into corners without marring woodwork.

FOR OPERATION INSTRUCTIONS SEE PAGE 33.

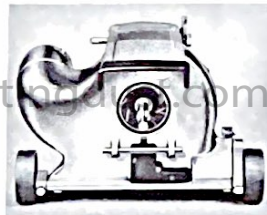

# How to use Your Kirby.

## KNOW YOUR KIRBY PARTS

- |                        |                             |
|------------------------|-----------------------------|
| 1. BAG                 | 19. MOTOR UNIT              |
| 2. BAG GUARD           | 20. CREVICE TOOL BRUSH      |
| 3. SANI EM-TOR         | 21. DUSTER BRUSH            |
| 4. FLOOR DUSTER PAD    | 22. MASSAGE CUP             |
| 5. LONG HANDLE         | 23. UTILITY BRUSH NOZZLE    |
| 6. BELT                | 24. UTILITY AIR NOZZLE      |
| 7. BRUSH ROLL          | 25. CRYSTALATOR             |
| 8. BELT LIFTER         | 26. SUCTION COUPLER         |
| 9. SUCTION RELIEF VENT | 27. BLOWER COUPLER          |
| 10. RUG NOZZLE         | 28. SURFACE NOZZLE          |
| 11. PORTABLE HANDLE    | 29. SWIVEL ATTACHMENT       |
| 12. HANDI-SHARPENER    | 30. CREVICE TOOL            |
| 13. HANDI-BUTLER       | 31. STRAIGHT EXTENSION TUBE |
| 14. SHOULDER STRAP     | 32. CURVED EXTENSION TUBE   |
| 15. HANDLE PIN         | 33. SPRAY & SUDS-O-GUN      |
| 16. POWER POLISHER     | 34. HOSE LOCKING NUT        |
| 17. CORD               | 35. FLEXIBLE HOSE           |
| 18. FLEXIBLE SHAFT     | 36. SWIVELED COUPLER TUBE   |

See illustration on page 13

HANDI-BUTLER PARTS  
ARE ON PAGES 18 & 19.

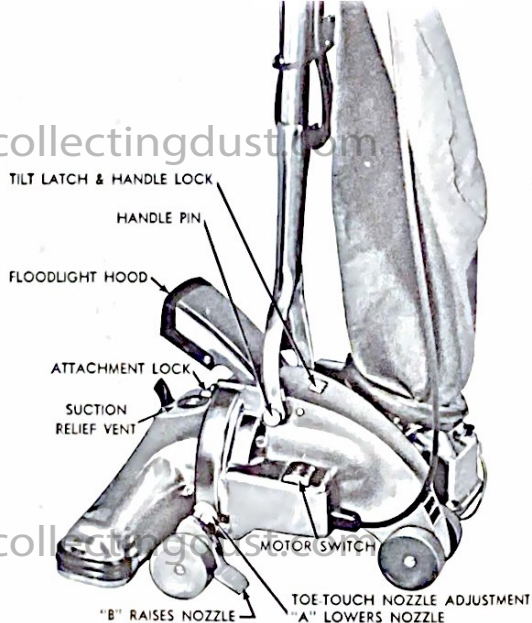

## MAJOR POINTS OF OPERATION

collectingdust.com

collectingdust.com

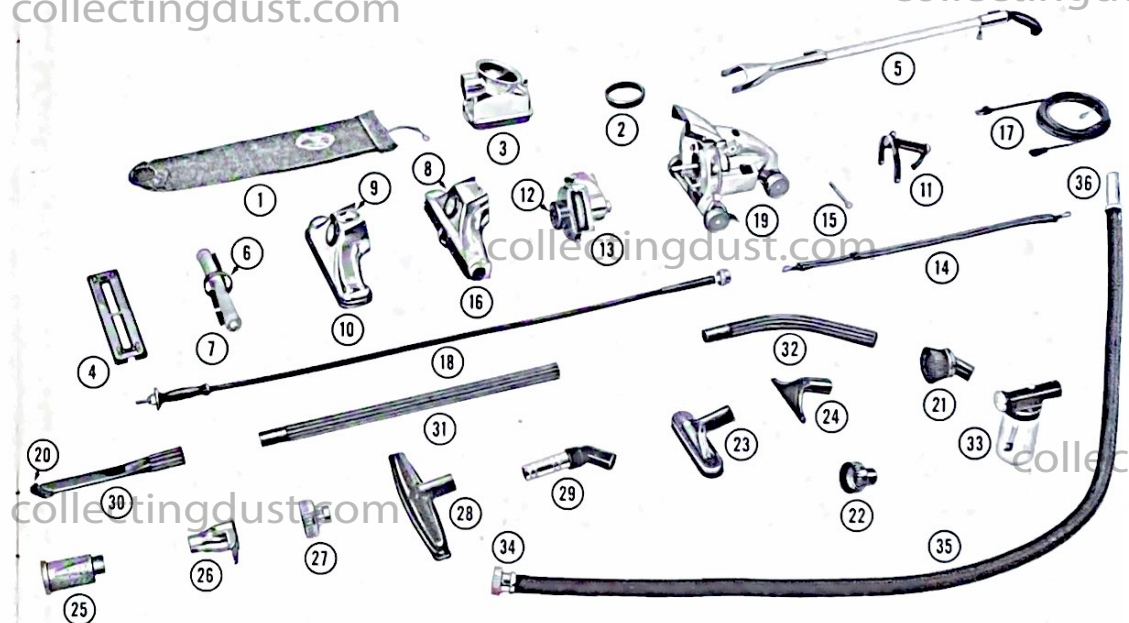





## HANDY TOOL CABINET

This smartly arranged cabinet is planned for maximum convenience in use and storage. It can be carried readily to the cleaning job . . . hung on a door knob or the back of a chair . . . keeps the tools handy while you are using any of the Kirby units. It can be stored away neatly and easily on the back of a closet door or any other suitable location.

Replacement of the tools is made easy by the outline drawings printed inside the cabinet.

## MOTOR SWITCH

The Kirby motor is turned on or off by depressing the red switch button on the side of the motor unit with either your toe or hand.

You will notice that the motor will not turn on or off until pressure on the button is released.

14

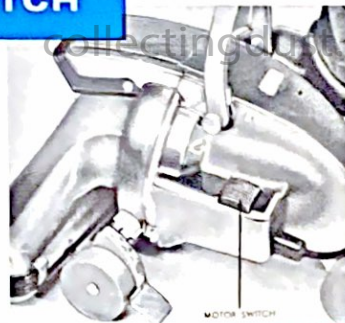
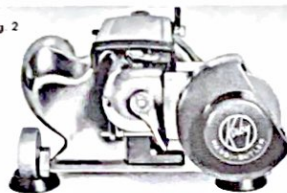

Fig. 2



## BELT LIFTER

### OPERATING INSTRUCTIONS

Belt lifters are found on the Rug Nozzle, Power Polisher and Handi-Butler. The operation of the belt lifter on the Rug Nozzle and Power Polisher are identical. The belt lifter on the Handi-Butler differs in appearance only and is explained on page 16.

The Kirby belt lifter makes it easy for you to change units. The belt transmits power from the motor to the Kirby unit. To change units, the belt must be removed from the belt drive shaft and replaced with the belt of another unit. The belt lifter does this for you.

On the front of the Rug Nozzle and the Power Polisher you will find the Kirby name plate. At the top of this name plate is a lever arm which is used in rotating the plate. Also on this plate you will find the words "ON" and "OFF".

As the first step in lifting the belt for attachment, turn the name plate so the word "ON" is against the stop pin. (See figure 4). Then look through the round opening at the back of the nozzle and make

certain that the belt is standing upright in the center of the brush. Also check the position of the belt on the brush roll by looking at the bottom of the nozzle. It should be in the center. Then turn the name plate counterclockwise until the word "OFF" is against the stop pin. (See figure 3). When the belt is new it will take a firm pressure to complete the turn. In turning the Belt Lifter to the "OFF" position you automatically pick up the belt on the metal finger and lift it so the Belt Drive Shaft can pass through the loop. (See figure 1). Your nozzle is now ready for attachment to the motor unit (see page 22). Once it is attached, simply turn the name plate clockwise to the "ON" position and the belt will be properly in place on the Belt Drive Shaft.



Fig. 3



Fig. 4



15

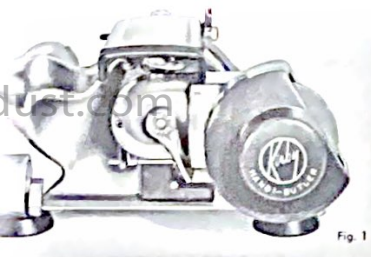

Fig. 1

## HANDI-BUTLER ATTACHMENT INSTRUCTIONS

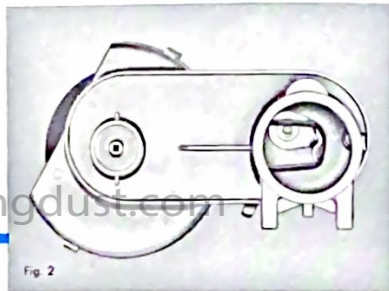

Fig. 2

On the front of your Handi-Butler you will find a lever which can be rotated between "ON" and "OFF" positions. This is the Belt Lifter for the Handi-Butler.

**STEP 1:** Set the lever in the "ON" position and by looking through the round opening at the back make sure the belt is over the metal finger. If it is not in place, use a lever such as a screwdriver to slip the belt over the finger.

**STEP 2:** Turn the Belt Lifter lever to the "OFF" position thus extending the belt (figure 2). The unit is now ready for attachment to the Motor Unit.

**STEP 3:** Raise the Floodlight Hood. Hold the Handi-Butler so the Attaching Slot is on the Attaching Bar which is just below the Belt Drive Shaft. (Figure 3) The Belt Drive Shaft should enter the large round opening and pass through the loop formed by the belt.



Fig. 3

**STEP 4:** The unit should then be swung back against the Motor Unit and at the same time a downward pressure should be applied to bring the other Attaching Slot into position on the Attaching Bar. In this operation you must overcome the spring tension on the safety switch button which is centered just behind the Attaching Bar.

While holding the unit in place, turn the Attachment Lock Lever to hold the unit in place (figure 4).

**STEP 5:** Turn the Belt Lifter lever to the "ON" position and the unit is ready for operation. Rubber cups which are provided may be placed under the front wheels to steady the unit (figure 3).

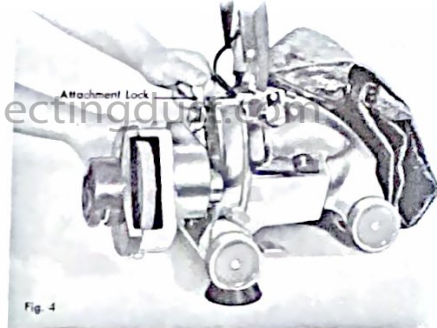
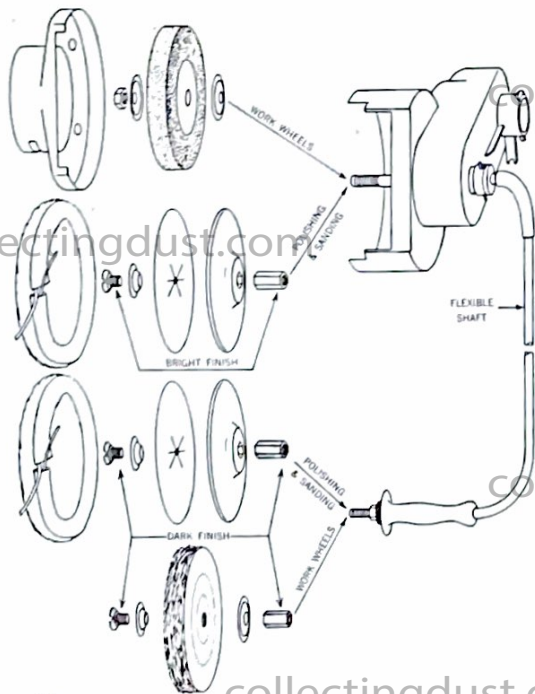

Fig. 4



Your Handi-Butler is an extremely versatile power tool and a brief review of these instructions will familiarize you with a whole new realm of time- and labor-saving advantages which are yours because you own a Kirby.

### THE ASSEMBLY OF WORK WHEELS

All work wheels, such as the grinding wheel, wire brush and buffing wheels, as well as the sanding disk and lambdowool polishing pad, may be attached to either the Handi-Butler itself or to the Flexible Shaft. However, since the direction of rotation differs between the Handi-Butler and the Flexible Shaft, different adapters must be used to attach the assembled work wheels. The screw and the adapter used on the Handi-Butler assemblies have left hand threads and are given a bright finish for easy identification. The screw and adapter used on the Flexible Shaft assemblies have a right hand thread and are given a dark finish for easy identification. Whenever the rubber sanding or polishing disk is used, the cone shaped washer must be used next to the screw. This washer is interchangeable between the Handi-Butler and the Flexible Shaft assemblies.

The drawings on the left show typical assemblies and in the case of the work wheels, the same sequence is followed with each.



#### WHEEL CUPS

Place under front wheels of motor unit



#### POLISHING COMPOUNDS

Store in cool place. See directions on wrapper



#### GRINDING WHEEL

Do not use if chipped or cracked. Wear safety glasses to protect your eyes when using this wheel



#### SHEETING BUFFING WHEEL

Use with red polishing compound No. 1 on metals such as brass or copper



#### FLANNEL BUFFING WHEEL

Used with light colored polishing compound No. 2 on precious metals such as gold or silver



#### WIRE BRUSH

Wear safety glasses to protect your eyes when using this versatile wheel



#### SANDING DISKS

Attach to rubber disk for light sanding



#### HANDI-SHARPENER

For use in sharpening knives per instructions on next page

## HANDI-BUTLER OPERATION INSTRUCTIONS

### ATTACHMENT OF FLEXIBLE SHAFT

To attach the Flexible Shaft, grasp the knurled collar of the bayonet connection and insert the core wire into the small hole at the rear of the Handi-Butler housing. Align the slots in the collar with the pins on the housing and with a firm forward pressure, twist to the right. When released the connection will lock firmly in place. A slight rotation of the Handi-Butler drive shaft may be needed to permit the core wire to engage with the drive shaft.

Caution should be taken to be sure the hand grip of the shaft is held in the hand whenever the power is on.

### WHEEL GUARD COVER

The Wheel Guard Cover is attached to the Handi-Butler housing by sliding its edge under the spring clips on the housing. Use this cover whenever using the work wheels or

the Handi-Sharpener for your protection. Abuse of this cover can result in breakage which is not covered in the guarantee.

### POLISHING AND BUFFING

The lambdowool polishing pad is stretched over the rubber disk and fastened by drawing the strings tight and tying. Be sure to tuck the loose ends under the edge of the pad. It is not necessary to have the sandpaper disk in place as the drawing on page 18 might imply. This pad is ideal for polishing waxed surfaces such as your table tops.

Your buffing wheels can help you restore the luster to your silverware or other decorative metal objects around your home. The sheeting buffing wheel is used with the red polishing compound No. 1 to polish brass, copper, or similar metals. The flannel buffing wheel is used with the light-colored polishing compound No. 2 to polish precious metals such as gold or silver. The polishing compounds are applied by holding the stick against the rotating wheel.

## HANDI-SHARPENER

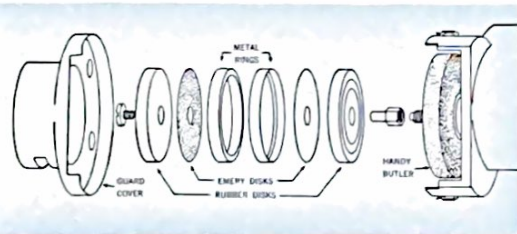

### USE OF THE HANDI-SHARPENER

Your Handi-Sharpener is completely assembled when you receive it. However, the above drawing diagrams the correct assembly for your use when it becomes necessary to replace the abrasive disks. When attaching the Handi-Sharpener to the Handi-Butler for use, be sure the grinding wheel, washers, and lock nut are securely in place. These units will automatically center the sharpener in the center of the slot on the guard cover. The plastic cover should always be used when sharpening a knife. To sharpen a knife, hold it with the edge to be sharpened upward. Insert the knife into the Handi-Sharpener as close to the heel of the blade as possible and while maintaining a slight upward pressure, draw the knife handle toward you. Keep the knife horizontal to the floor or table at all times.

Replacement abrasive disks for your Handi-Sharpener can be obtained from your Kirby dealer.

## SURFACE NOZZLE AND SWIVEL ATTACHMENT



This nozzle has been designed to facilitate the surface cleaning of carpets or hard surfaced floors under your low furniture. It will not deep clean your carpets as will the Kirby Floor Nozzle with Triple Cushion Vibration. However, it will do as good a job as any straight suction nozzle available.

By attaching the Kirby Floor Duster Pad as illustrated above, you can buff-dust your hard surfaced floors under low furniture. Here again, the Floor Duster is more efficient when used on the Kirby Floor Nozzle.

The swivel attachment is a separate unit so you can use it with any of the other dusting attachments.

A floating brush adjusts itself to the pile of your carpets to aid in the removal of surface dust and lint. Since it is mounted in the center of the air stream, it does not trap and hold dirt which would otherwise have to be combed free.

## TOE TOUCH NOZZLE ADJUSTMENT

This exclusive Kirby feature enables you to positively adjust the rug cleaning nozzle to the proper height for efficient cleaning of all floor coverings.

If the nozzle were set too high, there would be no cleaning action. If it were set too low, the cleaning action would be impaired and the machine would be hard to push.

To adjust the Kirby Rug Nozzle properly for your rug, simply depress the large lever (see "B" in illustration) with your toe as far as it will go. This raises the nozzle to the maximum height and the pointer will indicate No. 7 on the adjustment scale.

Now turn on the motor and depress button "A" with your toe. Each time you depress this button the nozzle will lower one notch. Continue to depress this button one notch at a time until you notice a change in tone of your Kirby. This indicates that the nozzle is at the correct level for the thorough cleaning of your carpet.

If the suction is broken with normal movement of the machine, lower the nozzle one more notch.

This same adjustment mechanism is used when operating the Hand Portable or the Power Polisher.

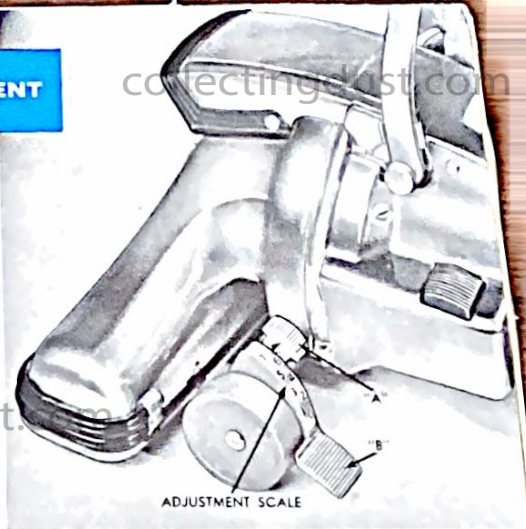
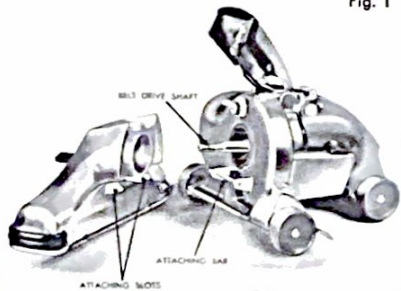

Fig. 1



## UPRIGHT CLEANER ASSEMBLY INSTRUCTIONS

The following units should be attached to the Motor Unit for use as an upright rug cleaner: Rug Nozzle, Long Handle, Sani-Em-Tor and Bag.

### ATTACHMENT OF RUG NOZZLE

- STEP 1:** Set Belt Lifter on Rug Nozzle for attachment as explained on page 15.
- STEP 2:** Set Toe Touch Nozzle Adjustment at No. 7 position on Adjustment Scale. (See instructions on page 21). Raise Floodlight Hood.
- STEP 3:** Place Attaching Slots at back of Rug Nozzle on the Attaching Bar. (see figures 1 and 2). Swing nozzle back toward Motor Unit with a slight downward pressure to overcome spring tension on Safety Switch (see figure 2). Hold nozzle in place with one hand and lock in place with Attachment Lock Lever at top-front of Motor Unit. (see figure 3).
- STEP 4:** Turn Belt Lifter to "ON" position (figure 4).  
To remove nozzle reverse these steps. Be sure to have Belt Lifter in "OFF" position before releasing attachment lock lever.

### ATTACHMENT OF LONG HANDLE

- STEP 1:** Remove Handle Pin from Motor Unit by pulling straight out with a slight twisting action.
- STEP 2:** Insert the fork of the Long Handle into the slide at top of Motor Unit (see figure 5).
- STEP 3:** Replace Handle Pin as far as it will go.

Fig. 2



Fig. 3

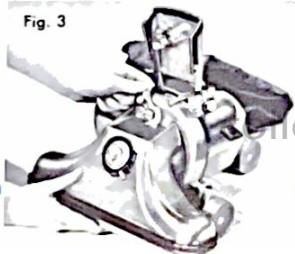

Fig. 4



### ATTACHMENT OF SANI EM-TOR

- STEP 1** On the inside of the Sani Em-Tor collar you will notice three curved slots. These should be lined up with the pins on the neck of the Motor Unit.
- STEP 2:** Slide the collar firmly over the neck and twist downward. The unit will lock firmly in place. (See Figure 6)

When the unit is new the rubber gasket inside the collar of the Sani Em-Tor will be stiff and offer some resistance. This gasket is necessary to give you an air-tight seal.

To remove the Sani Em-Tor simply twist from the bottom and away from the Motor Unit. It will unlock with a snap.

### SUCTION RELIEF VENT

Turn vent plate clockwise to open. When open, it is easier to clean efficiently long pile cotton or synthetic carpets and light weight throw rugs. Vent should be closed for normal, full power cleaning operations, and when emptying bag. See page 12 for location.

### ATTACHMENT OF BAG AND CORD

Plug the cord into the rear of the Motor Unit just below the Motor Switch. Fasten the cord hook to the clip just below the Handle Grip and wind down under the lower cord hook and up over the Swiveled Cord Hook. (Figure 7) Fasten the bag chain to the other side of the double clip.

For the operation of the Kirby Upright Cleaner also refer to pages 14, 21 and 24.

Fig. 5

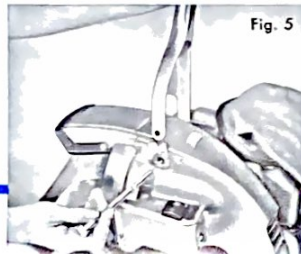

Fig. 6

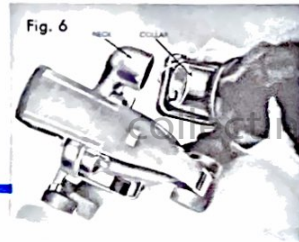
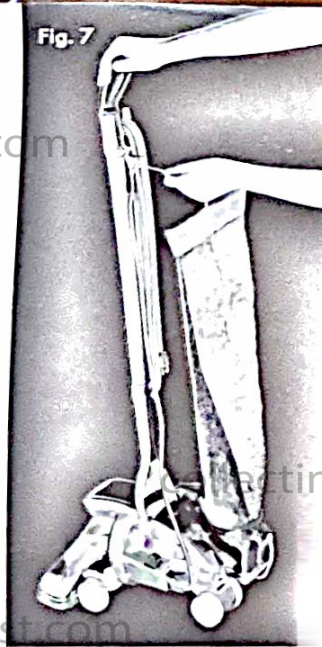
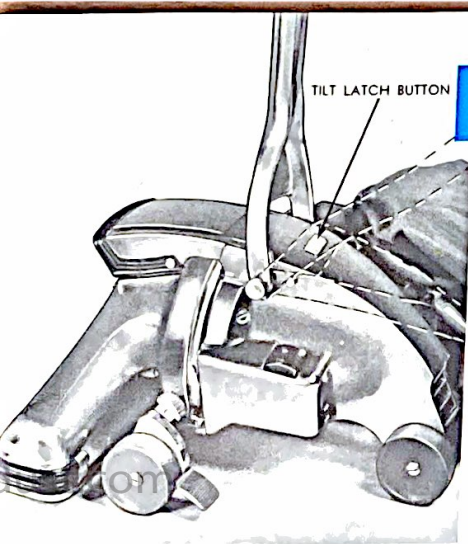

Fig. 7





TILT LATCH BUTTON

## TILT LATCH & HANDLE LOCK

### TILT LATCH

This latch permits the long handle to swing in an arc to a point where additional downward pressure raises the Rug Nozzle up and over the edge of rugs, electric cords and other obstructions. This action is accomplished by sliding the Tilt Latch button toward the motor switch side of the machine as far as it will go.

When it is necessary to push the Kirby under low furniture, the handle can be brought to a horizontal position simply by sliding the Tilt Latch button to the extreme opposite position — toward the bag or Sani Em-Tor.

### HANDLE LOCK

To lock the handle in the horizontal position for the cleaning of stair treads, etc., simply push the Tilt Latch button toward the switch side of the machine while the handle is in the horizontal position. It may be necessary to maintain pressure on the button as you gradually raise the handle.



## SANI EM-TOR EMPTYING THE BAG

The Sani Em-Tor is an exclusive Kirby device which enables you to empty the bag right in your home without muss, fuss or expense.

The Sani Em-Tor should be emptied after each thorough cleaning. If dirt is allowed to accumulate in the bag, the cleaning efficiency of your Kirby will be reduced; the bag will become difficult to empty; and it will provide an ideal place for germs to grow and multiply. It is just good housekeeping to keep the Sani Em-Tor and bag empty.

### EMPTYING THE BAG

1. Detach bag chain from handle clip.
2. Lower Rug Nozzle to No. 0 position (See page 21) and turn on motor.
3. Allow motor to run briefly and then turn off. While bag is still extended, shake it vigorously from the top.
4. Spread newspaper on the floor and place Kirby on it.
5. Tilt machine slightly and lift lock lever on the side of Sani Em-Tor to release plastic bottom.
6. Swing bottom tray out from under Sani Em-Tor and turn it upside-down, emptying the dirt and lint onto the paper.
7. After all dirt has been removed, swing plastic bottom back into place and lock securely with locking lever.

*If excessive dirt has accumulated in the bag, it may be necessary to force it through the Sani Em-Tor by pushing the bag down into the top of the Sani Em-Tor with your hand.*





## PORTABLE UNITS ASSEMBLY AND OPERATION

### HAND PORTABLE

Here is a powerful unit which will do a magnificent job of cleaning your deep cushions and stair treads. It is especially suited for use on your mattress.

To assemble, attach the following to the Motor Unit: Rug Nozzle (See Pages 15 & 22) The Portable Handle (Page 27) The Sani Em-Tor (Page 23). Hook the Bag Chain to the clip on the Portable Handle and with the Toe Touch Nozzle Adjustment (Page 21) set the nozzle height at the position-most suitable.

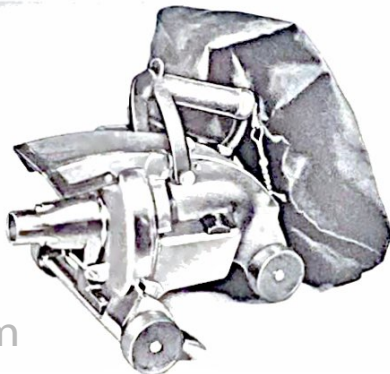

### SHOULDER PORTABLE

This unit is ideal for cleaning large areas where considerable mobility and freedom of hands are advantages. It is also convenient to use with the Handi-Butler and Flexible Shaft. To assemble, attach the following to the Motor unit: Suction Coupler and Flexible Hose, or Handi-Butler and Flexible Shaft (See Page 27 or 16 & 17), Sani Em-Tor and bag (Page 23), and the Portable Handle and Shoulder Strap (Page 27).

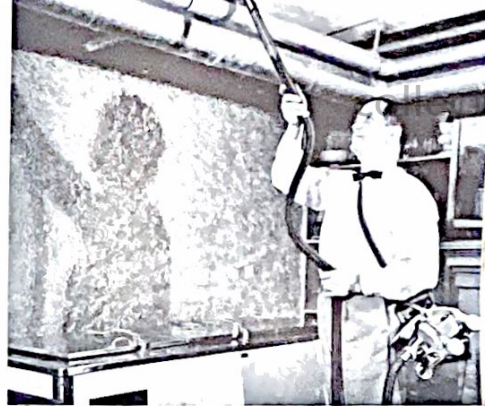

### FLOOR PORTABLE OR TANK-TYPE CLEANER

This is a unit which gives you the light-weight portability of a tank-type machine for above-the-floor cleaning operations around your home. Used with various combinations of the tools and extension tubes, you can clean those hard-to-reach areas in your home with ease.

To assemble, the following should be attached to the Motor Unit: Sani Em-Tor and bag, Suction Coupler, Flexible Hose, and appropriate extension tubes and tools. For complete portability, remove the Long Handle and replace it with the Portable Handle.

Extension tubes and tools are connected simply by inserting the tapered end of the hose or tube into the tool with a firm twist. To release simply twist and pull. A straight pull will not separate the parts if they have been properly assembled.

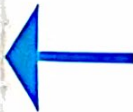

FOR ATTACHMENT INSTRUCTIONS  
SEE PAGE 27



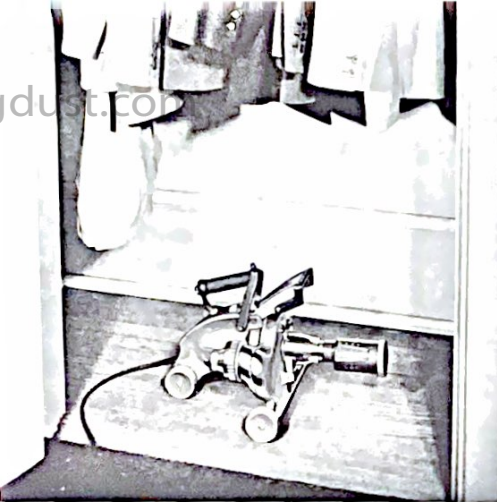

## CRYSTALATOR DE-MOTHING UNIT

To assemble, attach the Suction and Blower Couplers to the Motor Unit. The Flexible Hose may or may not need to be attached to the Blower Coupler depending on the intended use. Fill the Crystalator with Paradichlorobenzene Crystals (Moth Crystals) and attach to the Suction Coupler.

### FILLING THE CRYSTALATOR

Turn the cap so the "ON-OFF" marker lines up with the arrow on the red body of the Crystalator and lift off. Pour in crystals until the Crystalator is about half full when held in a horizontal position. A finger inserted into the inner cone will close the slot and prevent spillage. Replace cap and turn to desired setting: "Gas" for de-mothing a closet or other confined area; "Medium Crystals" for furniture, baseboards, carpets, etc.; "Full Crystals" when it is desirable to deposit large crystals in chests or storage boxes.

### ATTACHING THE CRYSTALATOR

Inside the neck of the Crystalator you will find a small lug. This must be lined up with the slot in the neck of the Suction Coupler as the Crystalator is pushed firmly into place.

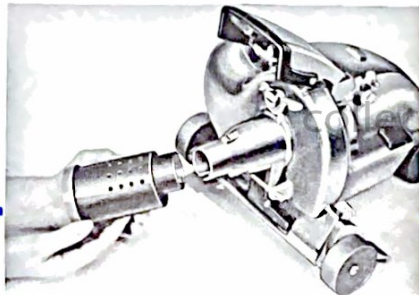

### USE WITH HOSE

Assemble the Crystalator Unit as described on the preceding page and also attach the hose and the crevice tool to the blower coupler. See illustration at the right. The crevice tool brush should be removed by squeezing the wire together at the point where it enters the tool and pulling straight out.

### DEMOTHING A CLOSET

Assemble the Crystalator Unit as described above and, without attaching the hose, place the unit on the floor of your closet. Turn the Crystalator cap to the "Gas" position, turn on the motor, and close the door. It is advisable to seal the crack at the floor with a throw rug. Allow the motor to run for from 5 to 15 minutes, depending on the size of the closet.

If Crystals are damp they will tend to cling together and stop the action of the Crystalator. If this happens, just place your hand over the holes in the top of the Crystalator body for a second while the motor is running. This will loosen the crystals and start them flowing into the fan chamber where they are exploded into a moth-killing gas.

### USING HOSE TO DIRECT GAS OR CRYSTALS







## SPRAY GUN & SUDS-O-GUN



### USE OF THE SPRAY GUN

Assemble the Floor Portable or Shoulder Portable unit as instructed on Page 29 except that the Blower Coupler and Flexible Hose are connected to the neck of the Motor Unit in place of the Sani Em-Tor. The Spray Gun is attached to the hose with a firm twist.

Paints should be thinned for spray application as instructed on the can. To fill the Spray Gun jar, unscrew from unit and fill about three-fourths full. Avoid over-filling to prevent spillage in use. Screw jar back in place firmly.

Turn on motor and adjust to proper spray. Turning the button at the top of the gun clockwise makes the spray finer. Depress button to spray, release to stop.

After use, be sure to clean gun by spraying a solvent through the gun. Wipe off exposed surfaces.

*Caution: When using paint or inflammable liquid, keep away from open flames.*

### USE OF THE SUDS-O-GUN

Assemble Spray Gun as explained above and place Suds-O-Gun cap over the front of spray gun—a clockwise twist will do it.

Mix detergent as directed on bottle, and fill jar about three-fourths full. Adjust gun to a *very fine* spray. A volume of very dry suds will then be produced. Suds can be piled directly on surface to be cleaned or gathered in a basin.

The suds should be worked into the surface with a brush or sponge until they disappear. Allow a few minutes for surface to dry thoroughly and vacuum with appropriate nozzle to remove the dry froth which now contains the grime and dirt.

## POWER POLISHER ASSEMBLY AND OPERATION



Assemble the Kirby as an upright machine (See Pages 22 & 23) with the exception of the Rug Nozzle. In its place attach the Power Polisher Nozzle. Attachment procedure is the same as for the Rug Nozzle (See Page 22).

Apply wax to the surface to be protected and allow to dry thoroughly before polishing. When wax is dry, set the Toe Touch Nozzle Adjustment to the lowest or "O" position (See Page 21) so the front wheels do not touch the floor. Set handle in normal cleaning position. Turn on the motor and the Polisher Brush will quickly polish your waxed floor to the highest possible luster. The best polishing results will be obtained when the polisher is resting on the rear wheels and the polisher brush.

By pushing the handle down against the Tilt Latch (See Page 24) it is possible to raise the brush and easily polish a six inch baseboard.

When storing the Power Polisher Nozzle, be sure to turn the Belt Lifter to the "ON" position. If you don't, the belt will become stretched and useless.



# How to Maintain and Service Your



## IMPORTANT:

Your Kirby Home Sanitation System is covered by a one year Factory Guarantee against faulty materials or workmanship, and a Lifetime Service Insurance Agreement and Fire Loss Insurance. See Pages 40 and 41.

The Kirby Distributor in your area stands ready to be of assistance to you at all times and his address should be put on the cover of this book for your future reference. If, at any time, you have need of the address of your closest service representative, you are welcome to contact the factory.

Your Kirby will give you many years of trouble-free service if you will care for and maintain it according to the suggestions made on the next few pages.

On the opposite page we have attempted to cover the various situations which might occur and which can be corrected easily by you at home without the inconvenience of having to contact a serviceman even though he is ready to help you at any time. If you are experiencing a difficulty, read over the various sections in this book pertaining to the problem and take the action indicated before you call a serviceman.

## HELPFUL HOME SERVICE HINTS

If Kirby will not pick up lint or ravelings on carpet, check to see if

1. Belt Lifter is in "OFF" position (Page 15)
2. Belt is broken or worn out (Page 37)
3. Brush needs adjustment (Page 36)
4. Toe Touch Nozzle Adjustment is improperly adjusted (Page 21)
5. Bag needs to be emptied (Page 25)
6. Brush needs cleaning (Page 36)

If motor will not run but floodlight lights up

1. Make sure either the rug nozzle, suction coupler, Handi-Butler or Power Polisher is properly in place.

If motor will not run and light does not light

1. Check to make sure cord is properly plugged into the machine and wall outlet.
2. Make sure there are no breaks in cord. Check by attaching to a floor lamp and flexing back and forth along entire length of cord. Pay particular attention to male and female connectors at ends of cord.

If Rug Nozzle is loose even after proper attachment

1. Attachment lock not turned tight enough.

If Sani Em-Tor (Dirt Trap) is loose

1. Check to be sure it is locked in position by turning clockwise as far as possible. (Page 23)
2. Check to see if rubber gasket inside collar of Sani Em-Tor is properly in place. If not, call for service.

If Power Polisher Brush will not revolve

1. Make sure Belt Lifter is in "ON" position.
2. Check condition of belt—replace if necessary. (See Page 37)

3. Make sure belt is not wet with wax.

If Handi-Butler work wheels will not revolve or stop under light pressure

1. Make sure Belt Lifter is in "ON" position.
2. Check belt and replace if broken, worn or stretched. (See Page 37)
3. Check locking nut to make sure it is tight.

If Handi-Butler locking nut will not thread on shaft

1. It is a left hand thread and must be turned counterclockwise to tighten.

If motor runs but light does not light

1. Check bulb for tight fit.
2. Bulb burned out—replacement needed.

If dirt will not fall out of bag and Sani Em-Tor

1. Too much dirt has been allowed to accumulate and it is jamming the large opening of the Sani Em-Tor where the bag is attached. Force the dirt through by pushing the lower portion of the bag down through the opening.
2. In an extreme case, it may be necessary to turn back the flap at the top of the bag which covers the bag clip and slide the clip off. The bag can then be emptied into an ash can or even vacuumed clean with the Kirby Floor Portable Unit and the Utility Air Nozzle. This must be done out of doors as there will be no means of trapping the dirt.

If Kirby is hard to push when Rug Nozzle is attached

1. Toe Touch Nozzle Adjustment set too low. Raise one or two notches. (Page 21)

## BRUSH ADJUSTMENT

Through usage, the revolving brush in the rug nozzle will gradually wear down. When it fails to protrude approximately 1/16 inch beyond the stainless steel rug guard — check by laying a flat piece of stiff cardboard across a portion of the rug guard — turn the brush roll adjustment screws at each end of the brush roll clockwise with a screw driver until the proper amount of bristle protrudes. Be sure to turn each screw an equal amount so the same amount of bristle protrudes on each end of the brush roll.

## BRUSH CLEANING

### TO REMOVE BRUSH ROLL FROM RUG NOZZLE

1. Remove nozzle from motor unit.
2. Turn Belt Lifter to "ON" position.
3. Swing Rug Guard from nozzle on hinges as pictured.
4. Spread support brackets by bending slightly away from Brush Roll. The brush may then be removed for cleaning.
5. Use scissors to cut string, thread or hair which may be wrapped around the brush roll. An old comb is also useful in removing foreign matter embedded in brush tufts.

### REPLACEMENT OF BRUSH ROLL

1. Place ends of Brush Roll into support brackets — one end is wider than the other so it can be replaced only the correct way.
2. Bend the support brackets back into place.
3. Make sure belt is positioned in center of Brush Roll.
4. Swing Rug Guard back into the nozzle — it will snap into place. It will be necessary to depress the belt slightly as this is done.

36

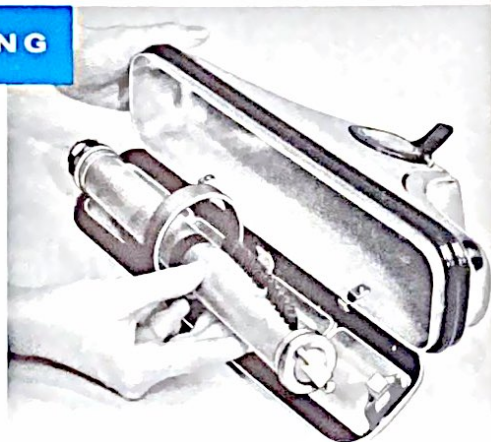

## BELT REPLACEMENT

### GENERAL INSTRUCTIONS

A belt in good condition is essential for the efficient operation of the Kirby Rug Nozzle, Power Polisher, and Handi-Butler. If any of these units fail to perform properly, the belt should be examined and replaced if it has become worn, stretched or broken.

The Kirby belt transmits the power from the motor to the Brush Roll of the Rug Nozzle and the Power Polisher, and to the work wheels on the Handi-Butler. Therefore, a belt in good condition is essential for the efficient operation of these units.

### RUG NOZZLE

If the Rug Nozzle fails to remove lint from the surface of the carpet or to properly vibrate the carpet, the cause of the difficulty may be a weak or broken belt.

To replace the Rug Nozzle belt, remove the nozzle from the motor unit and remove the Brush Roll from the Rug Guard as explained under Brush Cleaning on page 36 and as illustrated on the left. The worn belt can then be slid off over the end of the brush roll and replaced with a new one.



### HANDI-BUTLER

1. Remove Handi-Butler from motor unit.
2. Remove work wheels and washers.
3. Turn Belt Lifter to "ON" position.
4. With screw driver slide belt off Belt Lifter finger.
5. Remove belt by sliding it out over drive shaft to which work wheels are attached.
6. Replace new belt by reversing above steps.

37

### POWER POLISHER

Remove the Polisher from Motor Unit and turn Belt Lifter to "ON" position. Loosen the screw at one end of the nozzle about 1/2 to 1 full turn with a screw driver. Completely remove the screw and rubber bumper from the other end. Swing the Brush Roll out slightly being careful not to bend axle or remaining screw. Slide worn belt off open end and replace with a new one. Swing brush back into nozzle, line up axle with screw hole and replace screw and bumper. Tighten both screws firmly.



**LUBRICATION**

Your Kirby motor has been properly lubricated at the factory and should not need additional lubrication for several years. Lubrication should be done only by an authorized Kirby Serviceman. All other bearings are permanently lubricated and will need additional lubrication only after extreme use.

**BULB REPLACEMENT**

Lift lamp hood and remove old bulb by depressing and turning bulb counter-clockwise. It is a bayonet-type base and replacement is made by sliding small lugs on base of bulb down into slots in socket with a firm downward pressure and a clockwise twist. The bulb will lock into place.



**BAG MAINTENANCE**

Keep the plastic bag guard in place around the point where it is fastened to the Sani Em-Tor. This will minimize wear, and under average use your bag will last for many years. The only time it will need replacement will be at times of general overhaul. The bag is fastened to the Sani Em-Tor with a strong spring and reasonable strength and skill is required for its replacement.

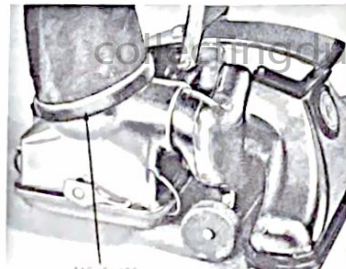

BAG GUARD

|                              | Pages              |                                   | Pages                     |
|------------------------------|--------------------|-----------------------------------|---------------------------|
| Air Refresher .....          | 10, 26             | Grinding Wheel .....              | 18, 19                    |
| Attachments .....            | 12, 13, 14, 27, 29 | Guarantee .....                   | 40, 41                    |
| Attachment Lock .....        | 22                 | Hand Portable .....               | 8, 28                     |
| Bag .....                    | 23, 27, 38         | Handi-Butler .....                | 4, 16, 17, 18, 19, 20, 37 |
| Bag Guard .....              | 38                 | Handi-Sharpener .....             | 20                        |
| Belt Lifter .....            | 15, 16             | Handle Lock .....                 | 24                        |
| Belt Replacement .....       | 37                 | Handle, Long .....                | 22, 23                    |
| Blower Coupler .....         | 27                 | Handle Pin .....                  | 22, 23, 27                |
| Brush Adjustment .....       | 36                 | Handle, Portable .....            | 27                        |
| Brush Cleaning .....         | 36                 | Hose .....                        | 27                        |
| Brush Roll .....             | 36                 | Hose Locking Nut .....            | 27                        |
| Buffing Wheels .....         | 19                 | Long Handle .....                 | 22, 23                    |
| Bulb Replacement .....       | 38                 | Lubrication .....                 | 38                        |
| Cord .....                   | 23, 38             | Maintenance .....                 | 34                        |
| Crystalator .....            | 5, 30, 31          | Mattress Cleaner .....            | 8                         |
| De-Mothing Unit .....        | 5, 30, 31          | Motor Switch .....                | 14                        |
| Dirt Trap .....              | 10, 23, 25         | Motor Unit .....                  | 12, 13                    |
| Electric Floor Duster .....  | 10, 26             | Parts .....                       | 12, 13, 18, 19            |
| Emptying the Bag .....       | 25                 | Polishing Compounds .....         | 18, 19                    |
| Extension Tubes .....        | 29                 | Portable Handle .....             | 27                        |
| Flexible Hose .....          | 27                 | Portable Units .....              | 28, 29                    |
| Flexible Shaft .....         | 18, 19             | Power Polisher .....              | 11, 33, 37                |
| Floodlight Replacement ..... | 38                 | Power Tool .....                  | 4                         |
| Floor Duster .....           | 10, 26             | Rug Cleaner .....                 | 9, 22                     |
| Floor Polisher .....         | 14, 33             | Rug Guard .....                   | 26, 36                    |
| Floor Portable .....         | 7, 29              | Rug Nozzle Adjustment .....       | 21                        |
|                              |                    | Rug Nozzle Attachment .....       | 22                        |
|                              |                    | Safety Switch .....               | 11                        |
|                              |                    | Sanding Disks .....               | 18, 19                    |
|                              |                    | Sani Em-Tor .....                 | 10, 23, 25                |
|                              |                    | Service .....                     | 34, 35                    |
|                              |                    | Shampoo .....                     | 6                         |
|                              |                    | Shoulder Portable .....           | 7, 29                     |
|                              |                    | Shoulder Strap .....              | 27                        |
|                              |                    | Spray Gun .....                   | 6, 32                     |
|                              |                    | Suction Coupler .....             | 27                        |
|                              |                    | Suction Relief Vent .....         | 12, 23                    |
|                              |                    | Suds-O-Gun .....                  | 6, 32                     |
|                              |                    | Surface Nozzle .....              | 20                        |
|                              |                    | Sweet Aire .....                  | 10, 26                    |
|                              |                    | Switch, Safety .....              | 11                        |
|                              |                    | Switch, Motor .....               | 14                        |
|                              |                    | Swivel Nozzle .....               | 20                        |
|                              |                    | Swiveled Cord Hook .....          | 11                        |
|                              |                    | Tank-Type Unit .....              | 7, 29                     |
|                              |                    | Tilt Latch .....                  | 24                        |
|                              |                    | Toe Touch Nozzle Adjustment ..... | 21                        |
|                              |                    | Tool Cabinet .....                | 14, 29                    |
|                              |                    | Triple Cushioned Vibration .....  | 9                         |
|                              |                    | Upright Cleaner .....             | 9, 22, 23                 |
|                              |                    | Wands .....                       | 29                        |
|                              |                    | Wheel Cups .....                  | 17, 18                    |
|                              |                    | Wire Brush Wheel .....            | 18, 19                    |



**CORD SERVICE**

The Kirby cord can be completely removed from the Kirby with ease for use as an emergency extension cord. It is well protected at all points of contact with the Kirby and will last for years with reasonable care.

Keep cord neatly wound on cord hooks on the long handle. Quick and easy removal of cord from hooks is possible by turning the swiveled cord hook at the top of the handle so the hook points down. The cord then slides off easily.

## KIRBY GENERAL COVERAGE GUARANTEE

This Guarantee is null and void if the name plate has been defaced, removed or changed in any way whatsoever from the condition in which it left the factory.

Kirby Guarantee, Service Insurance and Fire Coverage are in force only when the Kirby is purchased from an authorized factory distributor or dealer and the established price has been paid by the purchaser.

This Guarantee, Service Insurance and Fire Coverage are void if your Kirby is serviced by any other than an authorized Kirby Distributor, and unless Genuine Kirby Factory parts are used.

During one year from date of purchase, the Company after due examination will replace or repair any part the Company judges defective in material or workmanship. Delivery of such part, or the Cleaner itself, must be made prepaid to the factory or authorized Distributor during the period of the guarantee. Under any other circumstances a service charge will be made for sending a service representative to call for or deliver any cleaner or part.

Replacement of belts will not be made gratis, as the amount of use and care given the brush assembly determines their length of life. We cannot guarantee the life of light bulbs, nor do we guarantee the Handi-Butler guard cover against breakage.

If you cannot locate a nearby Distributor for required service, write The Scott & Fetzer Company, Cleveland 2, Ohio, for instructions.

Read the Instruction Book thoroughly, as failure to follow instructions may injure the cleaner and cause trouble for which the Company will not be responsible.

The Company will in no case be responsible for damage or breakage caused by accident, misuse, abuse or damage resulting from owner's tampering or repairs attempted by unauthorized service men.

No verbal or written agreement on the part of the salesman or Distributor other than contained herein is valid or binding on the manufacturer and should not be accepted by the purchaser.

"The above guarantee shall only cover the Kirby Cleaner if the same be purchased from a dealer duly authorized and enfranchised by the manufacturer."

### GENERAL SERVICE INSURANCE

The manufacturer and/or distributor hereby agree to entirely rebuild and recondition a Kirby any time after the expiration of the factory guarantee and as often as the original purchaser may require, providing it is still in the possession of the original owner, as set forth in the following:

1. The manufacturer and/or distributor in rebuilding the machine for the purchaser will make every effort to keep the cost to the customer for this service as low as possible and the manufacturer will in no case charge the customer more than \$17.50 for any one rebuild.
2. The price of \$17.50 (maximum for rebuilding service) shall include all labor and cost of parts necessary to put the machine in A-1 condition and no extra charge will be made other than transportation.

## GENERAL SERVICE INSURANCE

*For the "Kirby" in the home*

3. If a Kirby owner should desire to have an authorized Kirby distributor do the rebuilding as outlined above, said distributor to compensate for transportation charges that he must pay on genuine Kirby parts, may charge up to but not in excess of \$22.50 for any one rebuilding. It is to be noted that the distributor's rebuilding charge in most cases represents a substantial saving to the Kirby owner as compared to the factory rebuilding charge plus transportation. Also, local distributors can generally save considerable time in the rebuilding process.

### COVERAGE OF LOSS BY FIRE

1. In the event that this Kirby, while in the possession of the original purchaser should be damaged by fire on the premises of the original purchaser, the manufacturer will repair or rebuild the Kirby for the customer and return the equivalent of a new Kirby of the same model providing the customer will send \$17.50 and the fire damaged remains prepaid to our factory within 90 days after date of the damaging fire. If cleaning tools also need replacing by reason of fire damage, an additional charge of \$5.00 will be made. Return transportation to the customer's home will be paid by the customer. If the Kirby Power Polisher, Handi-Butler, Flexible Shaft or Surface Nozzle and Swivel Attachment are damaged or destroyed by fire, The Scott & Fetzer Company will replace Kirby Power Polishers at a cost of \$7.00 each to the customer, Kirby Handi-Butlers at a cost of \$8.00 each, Flexible Shaft at a cost of \$5.00 each, and the Surface Nozzle with Swivel Attachment at a cost of \$3.00 each, all F.O.B. Cleveland, Ohio.

This service is based solely upon the condition that the customer has met with all the requirements of the purchase agreement, and it is distinctly understood that said replacement will in no way nullify the terms of that purchase agreement.

2. In the event that the Kirby, cleaning tools, Power Polisher, Handi-Butler, Flexible Shaft, or the Surface Nozzle and Swivel Attachment while in the possession of the original purchaser shall be completely and wholly destroyed by fire so that no damaged parts can be returned, an affidavit sworn to by the original owner before a notary public will be accepted within 90 days after date of damaging fire in lieu of damaged parts and the Kirby and/or attachments will be completely replaced under the terms set forth in section one above.

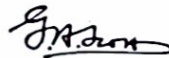

President  
THE SCOTT & FETZER CO.  
Manufacturers of the  
Kirby Home Sanitation System

This Guarantee Covers Kirby Model 518

(Serial No.) \_\_\_\_\_

Date of Original Purchase \_\_\_\_\_



Manufactured by  
**THE SCOTT & FETZER COMPANY**  
1920 WEST 114TH STREET  
CLEVELAND, 2, OHIO