



**GUARANTEE AND
INSTRUCTION BOOK**

Write in serial number.....

MODEL 513 KIRBY SANITATION SYSTEM

First Aid...

There are a few simple things for you to do before calling for the Service Man. Years of experience and dealings with hundreds of thousands of Kirby owners show that one of the following things may happen:

1. If the motor will not run, although the flood-light lights up when the Start-Stop switch is turned

down...remember the Kirby is equipped with a Safety Switch which doesn't permit the motor to operate until all moving parts are enclosed. See Page 8 of this instruction book.

2. If you experience difficulty in picking up ravelings or lint, probably the bag needs emptying. Also, see Page 20 on the adjustment or replacement of the rotary brush or belt.

Notice...

Should you ever have occasion to communicate with the distributor or manufacturer regarding your Kirby, be sure to mention the *model* and *serial number* of the machine as shown on the name-plate located on the bottom of the fan case. Write it in the space provided on the cover of this booklet.

KNOW YOUR "KIRBY"...

collectingdust.com

A new word has been added to the vocabulary of the Kirby owner . . . HOME MAINTENANCE! The Kirby Sanitation System has led for many years in the services of efficiently cleaning and removing the dust and dirt from your home and its furnishings. Now, new Kirby units have been added which extend the range of its usefulness into house-keeping or maintenance. The additions of the Handi-Butler, new Power Polisher and the Suds-o-Gun have been noteworthy.

We want you to receive full value in your purchase of the Kirby Sanitation System and recommend your close attention and thorough reading of its presentation in the following pages.

Keep this booklet. Although we have tried to make

it complete in its presentation of the many units and features, there still remains a multitude of uses not even mentioned. However, after you have read it, you will have a workable idea of the things into which the designers of the Kirby have put much time, thought, effort and money.

The Kirby is delivered to you shiny-new and in perfect adjustment, all ready to be put to work. You start with the best machine of its type in the world, and it will continue to give you the best of service if you give it a reasonable amount of care.

Read and review this booklet in order to secure the maximum use from this wonderful array of Kirby units and exclusive features. **KNOW YOUR KIRBY!**

NAMES OF KIRBY* PARTS

MAJOR PARTS

- 1 — Bag
- 2 — Sani Em-tor
- 3 — Brush Roll
- 4 — Rug Nozzle
- 5 — Belt Lifter
- 6 — Motor Unit
- 7 — Floodlight Cover
- 8 — Handle Pin
- 9 — Long Handle
- 10 — Cord

AUXILIARY TOOLS

- 11 — Floor Duster
- 12 — Flexible Hose
- 13 — Lifter Grip
- 14 — Shoulder Strap
- 15 — Straight Extension Tube
- 16 — Curved Extension Tube
- 17 — Coupler Tube
- 18 — Massage Cup
- 19 — Crystalator
- 20 — Suction Coupler
- 21 — Blower Coupler
- 22 — Utility Brush Nozzle
- 23 — Utility Air Nozzle
- 24 — Duster Brush
- 25 — Crevice Tool

* YOU CAN IDENTIFY THESE PARTS BY NAME OR NUMBER

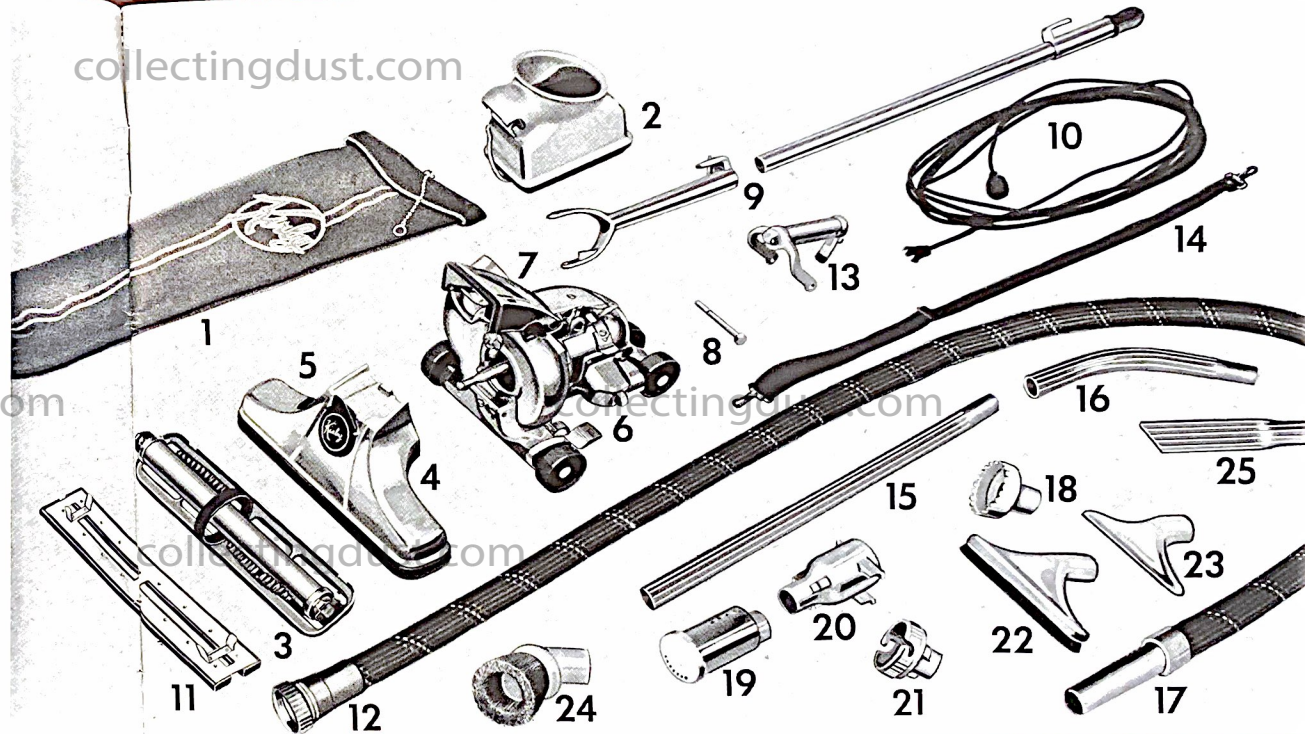

Contents

collectingdust.com

Pages

FIRST AID	1
KNOW YOUR KIRBY	2
NAMES OF KIRBY PARTS	3-4
ASSEMBLY AND OPERATION	
Handle	6
Electrical Connection	6
Name Designation	7
Safety Switch	8
Operation of Belt Lifter	9-10
Rug Cleaner Nozzle	11
Suction Coupler	12
Triple-Cushioned-Vibration Rug Cleaning Action	13
Nozzle Height Adjustment	14
Tilting Rug Cleaner Nozzle	15
Sani Em-tor	16
To Empty Dust Bag Through The Sani-Em-tor	17-18

HOW TO KEEP YOUR KIRBY WORKING AT ITS BEST.....	19
Keep The Brush Clean	19
Adjustment of Brush	20
Installation of New Belt	20
Lubrication	21
Floodlight Bulbs	21
Tool Cabinet	22
AMERICAN HOME CHART — 8 Complete Units.....	23-24
Crystalator or De-mother	25
Spray Gun	26
Suds-O-Gun	27-28
Floor and Shoulder Portable	29-30
Mattress Cleaner	31
Rug Cleaner	32
Electric Floor Duster	33
Power Polisher	34
General Coverage Guarantee	35
General Service Insurance	36
Coverage of Loss by Fire	36

ASSEMBLY AND OPERATION

collectingdust.com



Handle . . . After the handle has been joined together and tightened with a screwdriver, remove the handle pin from the top of the power unit, and drop the handle into the notch. Line up the holes in the handle with those in the top of the power unit and press the pin into place.

Electrical Connection . . . Plug the extension cord end into the Push-Push Switch. Place the wire loop of the cord over the small hook on the rear of the handle. Wind the cord *downward* under the bottom hook on the handle, and, then, wind upward over the top hook. The bag is attached after the cord is in place. This precludes any loosening of the plug by the tugging of the bag when it is inflated.





Know the names of important points of operation.

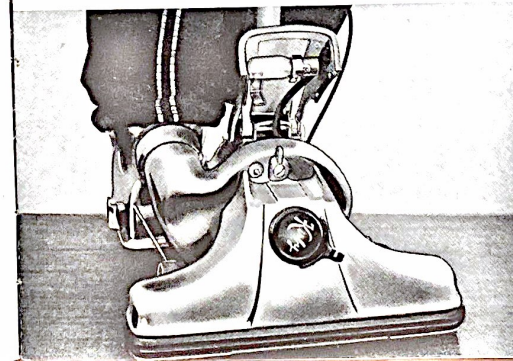
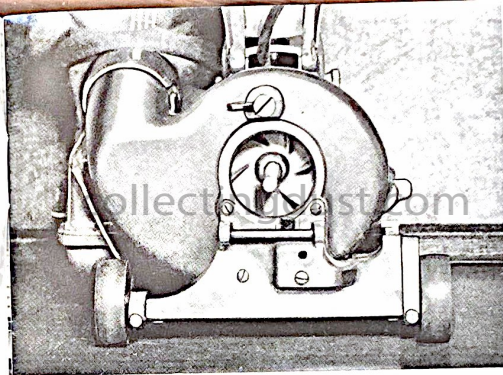

S A F E T Y S W I T C H

The Patented Safety Switch prevents the operation of the motor when the fan blades are exposed, even though the Start-Stop switch has been turned on. When the Rug Cleaner Nozzle, Power Polisher, Suction Coupler or the Handi-Butler are in place, covering the fan blades, the motor will run when the Start Switch is moved into the "ON" position.

OPERATION OF PATENTED BELT LIFTER

This is the back view of the Rug Cleaner Nozzle. The Belt Lifter hook can be seen through the round opening, stretching the belt in readiness for attachment of the nozzle to the Power Unit.

This is the front view of the Rug Cleaner Nozzle, with the Belt Lifter lever turned to the position in which the belt is OFF the drift shaft of the motor. The belt is stretched over the hook of the Belt Lifter in readiness for the attachment of the nozzle to the Power Unit.

With the Rug Cleaner Nozzle in place, the Belt Lifter lever is turned to the "Up" or "On" position . . . the Belt Lifter's hook has been turned so it drops the belt down onto the motor drive shaft, ready to turn the rotary brush.

Perhaps the easiest way to tell you about the Belt Lifter is to say that it is the mechanism designed to make easy the formerly tough task of placing the drive belt on the motor shaft. The rotary brush in the Rug Cleaner Nozzle is driven through this belt. Before attaching the nozzle to the motor unit, it will be necessary to place the belt over the hook of the Belt Lifter. This hook is an integral part of the nameplate on the nozzle and cannot be removed. Hold the nozzle in the left hand with the nameplate down. Grasp the Belt Lifter nozzle cap "lever" with the right hand and turn it to the "ON" position. Look in the round opening on the back of the nozzle. Then rotate the lever as far as it will go. Make sure that the loop of the belt is caught by the hook of the belt lifter. The belt is then in position for the attachment of the nozzle to the motor unit. Then

drop into driving contact on the motor shaft by a turn of the belt lifter lever. The belt lifter should not be left in the "OFF" position for any extended length of time because it stretches the belt.

Page 9

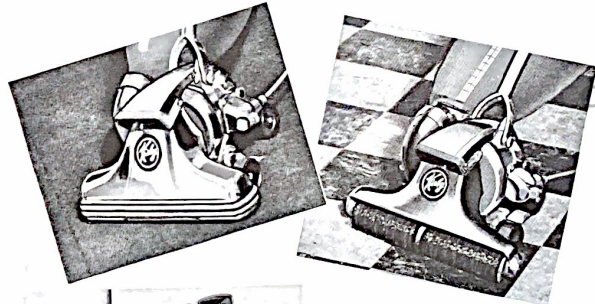
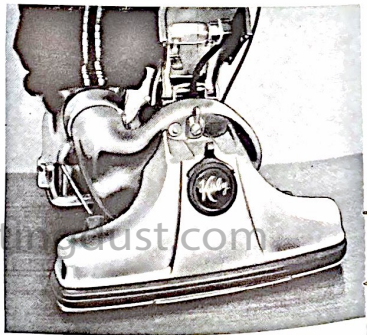
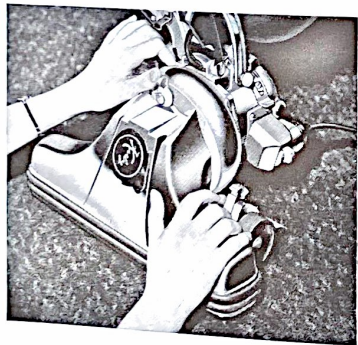
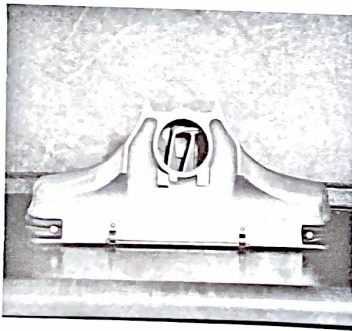

- A — Rug Cleaner
- B — Power Polisher
- C — Handi-Butler

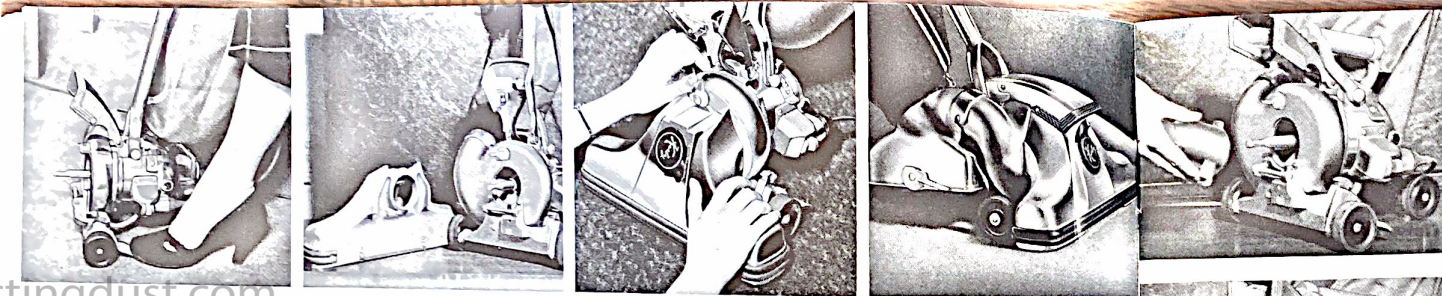

To put patented 'RUG CLEANER NOZZLE' into operation

Step on the Toe-Touch Control, raising the Power Unit to the top height, position number seven. Raise the Floodlight cover, exposing the cam lock which locks the nozzle into place. Place the notched lugs on the back of the nozzle over the horizontal shaft of the fan case located under the motor shaft. Press downward on the nozzle to compress the

spring in the Safety Switch, tilt the nozzle firmly against the face of the Fan case, and turn the Cam Lock lever locking the nozzle firmly into place. Turn the Belt Lifter lever to the "ON" position with the word "ON" against the stop pin, and the nozzle will be ready for work. To remove the Rug Cleaner Nozzle, just reverse this procedure.

Attaching Suction Coupler

Hold the Suction Coupler lightly in the palm of the hand parallel with the fingers. Hook the lugs over the shaft located directly under the motor shaft on

the face of the fan case. Use the other hand to turn the cam lock latch until it holds the Suction Coupler firmly in place.

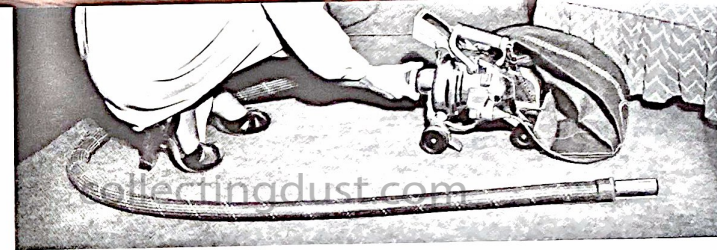
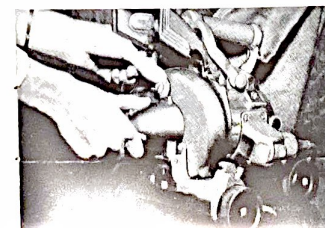
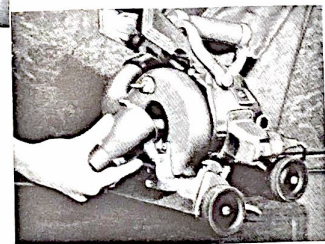
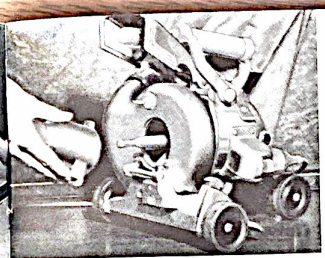

Attaching Flexible Hose

Hold the Power Unit firmly with the left hand, the Flexible Hose laid out in front of the machine, the hose coupler ring held firmly in the palm of the right hand, and it is ready to be locked into place. The coupler ring of the hose should be held in place over the suction or Blower Coupler and rotated slightly. 'Feel' for the right slot, and twist-turn it into place. The Flexible Hose is placed on the suction end when a cleaning operation is intended, and on the blower end when the Spray, Suds-O-Gun or the Crystalator are to be used.



collectingdust.com

collectingdust.com

collectingdust.com

collectingdust.com

Triple-Cushioned

VIBRATION RUG CLEANING ACTION

A positive, yet gentle, way of shaking loose the embedded dirt in a rug, sweeping and carrying the dirt away. Triple-cushioned refers to:

1. A plastic cap on each end of the brush roll which cushions the brush roll mechanism.
2. Long, resilient bristles in the rotating vibrating brush, which bend and cushion their sweeping action.
3. The rug is lifted from the floor to the face of nozzle and so is vibrated and swept while supported by a cushion of air.

For thorough rug cleaning, push the cleaner slowly, otherwise you may "break the suction." Look at No. 3 on the chart. When the suction is "broken" the rug drops to the floor and the cleaning action stops. If the cleaner doesn't pick up threads and lint, look at the belt which drives the rotary brush and see if the tension is such that the brush rotates when held lightly against the rug. The brush must be clean and the bristles adjusted properly.

To Adjust Nozzle Height for Efficient Rug Cleaning . . .

The many new kinds of rugs in use today make the proper adjustment of the nozzle height more important than ever before. If the nozzle is too far off the rug's surface, it won't clean at all, and if it is too close, pushing down and resting on the rug, it won't clean efficiently and might be hard to push. Therefore, a device is provided with which the nozzle can be adjusted to the proper cleaning height. The Toe-Touch Control is the semi-automatic way of raising and lowering the nozzle. Button A is used for raising the nozzle and Button B is used for lowering the nozzle a notch at a time. These adjustments are made by pressing the buttons with the toe of your shoe. This is a comparatively easy and quick way of accomplishing this important adjustment.

Place the Rug Cleaner Unit on the carpet or rug, press Button A and raise the adjustment to No. 7 on the indicator (the top position). Start the motor and lower the nozzle a notch at a time by pressing Button B until you see the rug drawn up to the nozzle by the suction and a noticeable deepening in the tone of the motor occurs. In this way you can know when you have the best nozzle adjustment for the cleaning of each particular rug.

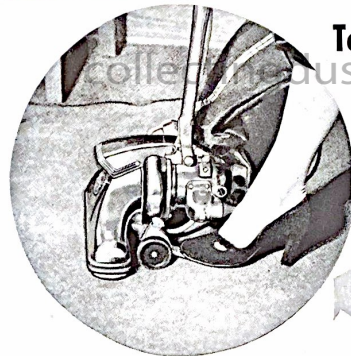

TO RAISE



TO LOWER

TILTING THE RUG CLEANER NOZZLE . . .

There is a Tilt Latch adjustment for the handle which permits the handle to swing in an arc to a point where a pressure downward tilts the Rug

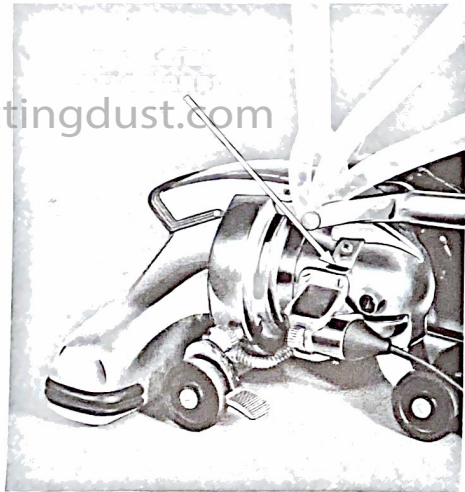

Cleaner Nozzle up and over the edges of rugs, electric cords, etc. This is the most important use of the Tilt Latch, although there are two more adjustments. The three settings of the Tilt Latch handle adjustment are: 1. Full Handle Swing — The position in which the latch is upward as far as it will go. This permits the handle to swing freely, and is the setting for pushing the machine under beds or similar low pieces of furniture. 2. Tilting — To make this setting, stand the handle straight up and push the Tilt Latch slide down as far as it will go. Then, when you push the handle down, you will find there is a point where it stops, and added pressure put on the handle tilts the machine. In this way, the machine is tilted over the edges of rugs, when going from room to room. Also, this setting is useful in cleaning the fringe on rugs. 3. Locked Down — With the latch in the "UP" position, swing the handle down as far as it will go. Then lock the handle in this position by sliding the latch downward as far as it will go. This setting holds the handle and machine in a straight-out, rigid position suitable for cleaning stairways, mattresses and furniture seats.

The *Sani Em-tor*

(Patented)

is the device through which the collected dirt is emptied from the bag. In order to attach it to the Power Unit, tilt the Unit to the side with the blower or exhaust opening 'up'. Place the slots located in the neck of the Sani Em-tor over the pins on the exhaust opening, and twist-turn into place. The bag need never be removed from the Sani Em-tor except to attach a new one. The accidental puncturing or wearing of a bag, which would necessitate the attachment of a new one, is rarely encountered. The stiff coil spring sewed into the bottom of the bag holds it securely to the Sani Em-tor.



TO EMPTY DUST BAG

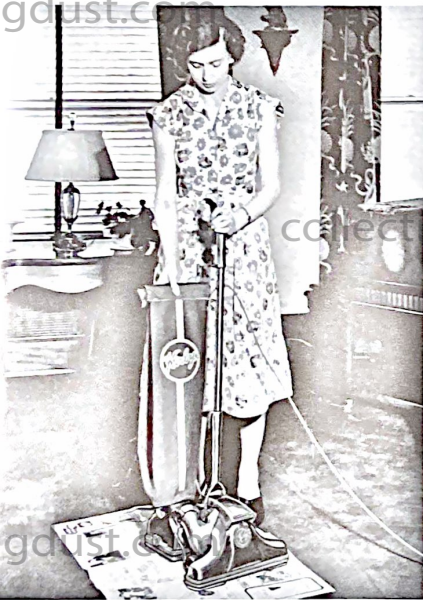

SANI EM-TOR!

Spread several thicknesses of fully opened newspaper on the floor, place the machine in the center of the paper, and lower the Rug Nozzle to position "O" on the Toe-Touch Control. Remove the bag chain from the hook attached to the handle-grip and, holding the bag at the top, shake the dirt contained in the bag, down into the Sani Em-tor.

Then turn the cam lock lever found on the side toward the bottom of the Sani Em-tor. Swing the bottom part of the Sani Em-tor, or trapdoor, out and from under, turning it over so that the dirt resting in the trapdoor will drop down onto the paper. The heavy, gritty dirt contained in the bag and the Sani Em-tor will drop out freely. If the bag is unusually full of dirt, it may be necessary to grasp the outer sides of the bag in your two hands and work loose the lint and dirt which clings to the inside walls and push it downward and through the Sani Em-tor. Replace the bag chain loop upon the handle hook. Now swing the bottom of the Sani Em-tor back into place and lock by turning the lever a full half turn. The emptied dirt can then be wrapped in the newspaper and easily disposed of.

AIR REFRESHER!

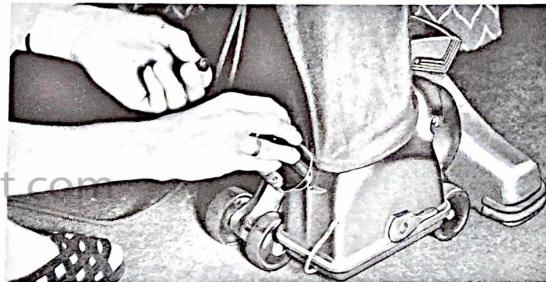

Odors are always present. Here are a few of the many household ones: Cooking, kitchen stove, tobacco, mustiness, bathroom, paints, papering, perspiration, sick room, animals (pets), laundering and household commodities (glue, rubber, leather, and cleaning compounds). You can get rid of unpleasant odors with the Kirby Air Refresher and do this while cleaning the house. Pour in just a few drops where you see the red button and push the button starting the motor . . . the unpleasant odors disappear like magic!

EXCLUSIVE WITH KIRBY

HOW TO KEEP YOUR KIRBY WORKING AT ITS BEST...

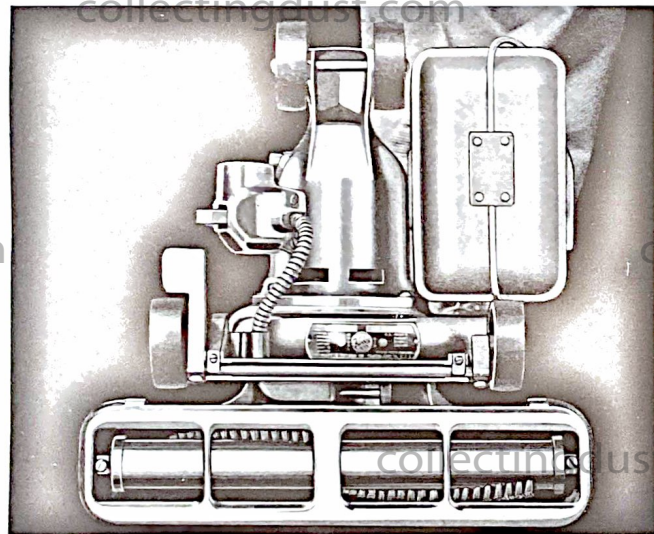

Brush Cleaning . . . Keep it clean! Remove the thread and hair that wrap around the brush. A pair of scissors and an old comb are useful tools. Also remove the brush and clean any collection of hair and lint from around the end cap found at each end. To remove brush: Remove the nozzle from the motor unit. Turn the belt lifter handle to "on". The brush assembly and the rug plate will pull off the bottom of the nozzle as a unit.

To replace, make sure the notches in the rug plate are to the rear of the nozzle. Push the unit onto the end of the nozzle. Place the belt on the hook of the belt lifter and turn handle to "off" position. The nozzle will then be ready to place on the motor unit.

Adjustment of brush to compensate for bristle wear . . .

As the bristles on the brush wear, it will be necessary to adjust the brush to regain brushing efficiency. Adjust the brush by turning the adjustment screws clockwise. Turn the screws the same amount at each end so the bristles extend evenly along the full length of the nozzle. The bristles should protrude 1/16" below the nozzle edge.

Replacement of worn-out brush . . .

Remove brush and rug plate assembly as described on Page 19.

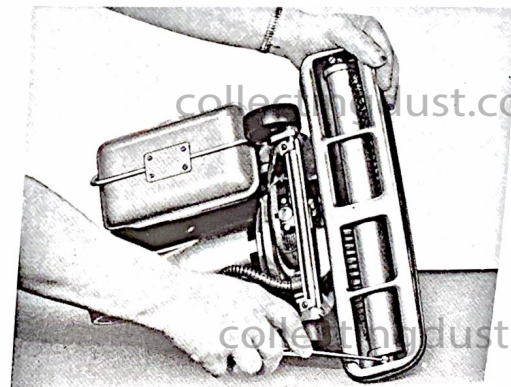

Remove brush from rug plate by holding the brush in one hand, one "ear" of the rug plate spring in the other hand. Push the brush one way and the "ear" the other way. The new brush will go in by the same method. The notches that carry the brush roll are of different widths so that it is impossible to assemble it in any other way but the proper way.

Installation of new belt . . .

Remove rug plate as described on Page 19. Remove one end of brush from "ear" of rug plate as described under "Replacement of worn-out brush". Slip on new belt and replace roll into spring. Assemble to nozzle as described on Page 19.

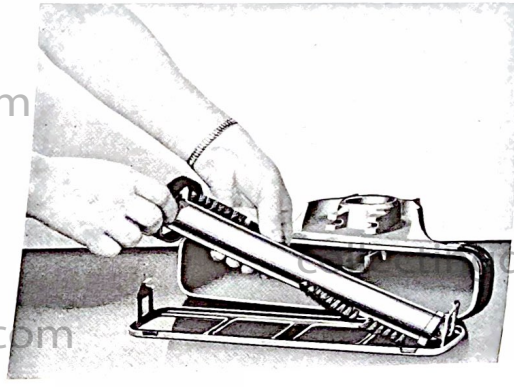

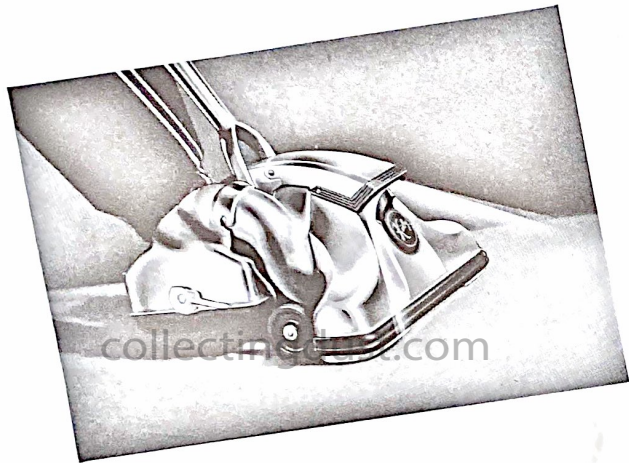

FLOODLIGHT BULBS . . .

To replace, raise floodlight cover, and note that socket assembly has a clamp that fastens around the metal base of the bulb. The base of the bulb is of the bayonet type, similar to those used in

automobile headlights. Turn the bulb slightly counter-clockwise, or to the left, push in at the same time, and then pull out. Do not force. If it is done right it will come out with a firm but gentle pressure. Reverse this procedure to install the new bulb. We cannot guarantee the life of the light bulbs. Replacements can be secured from your Kirby distributors.

LUBRICATION . . .

The ball bearings in the motor and in the brush are packed in grease. They should not require any additional grease for a number of years with average use in the home. Should any difficulty develop, consult your Distributor immediately, or write the Factory Service Department for instructions.

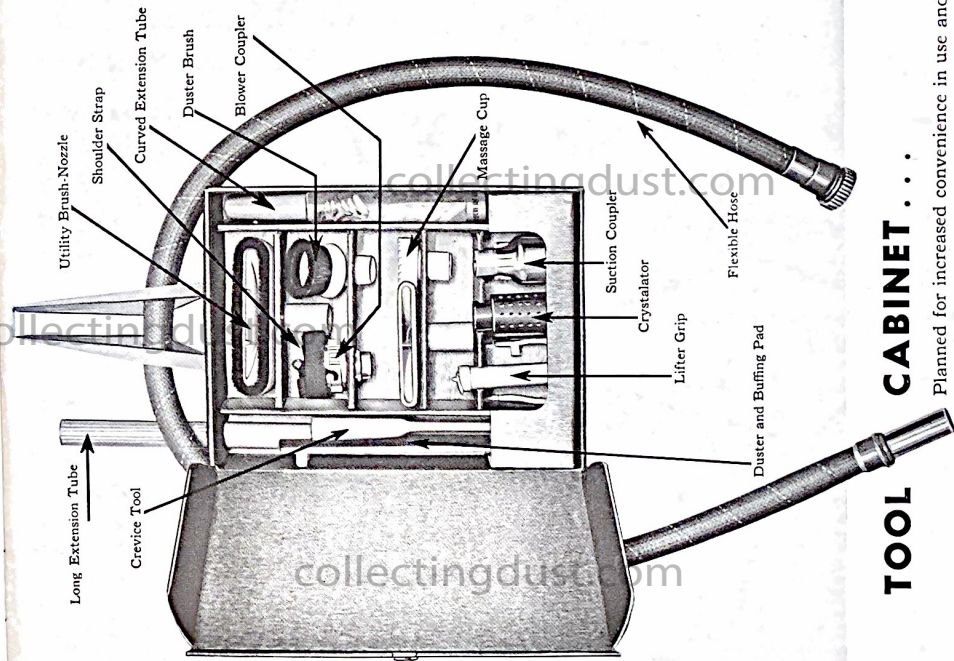

TOOL CABINET . . .

Planned for increased convenience in use and storage. It can be carried to the job . . . hung on a doorknob or the back of a chair . . . keeps the tools handy while you use the Kirby units. It can be stored away neatly and easily on the back of a closet door, a space which wouldn't otherwise be used.

1. Crystalator or Demother



Furs, suits, overcoats, sweaters, caps, gowns, pillows, blankets, comforters, bathing suits, mufflers . . . and other woolens and fabrics. Under rugs, baseboards and kitchen sinks. Into cupboards, drawers, bookcases, trunks, pianos, overstuffed furniture . . . and other usually inaccessible places.

3. PORTABLE



Unit on the floor: Walls, baseboards, tapestries, lamp shades, venetian blinds, radiators, brick fireplaces, window drapes and pianos. Reaching tubes added: Ceilings, moldings, lighting fixtures, windows and doors. Shoulder Strap added: Attic, basement and automobile.

4. MATTRESS CLEANER



Mattresses, heavy thick cushions, upholstered furniture, and carpeted stairways.

2. SPRAY and SUDS-O-GUN



Lacquers, paints, insecticides, floor wax, antiseptic . . . atomizes any liquid. With the Suds-O-Gun attached, extra-dry suds for the shampooing of rugs, tapestries and upholstered furniture.

8 COMPLETE UNITS

A Multitude of Uses for
in the Home!

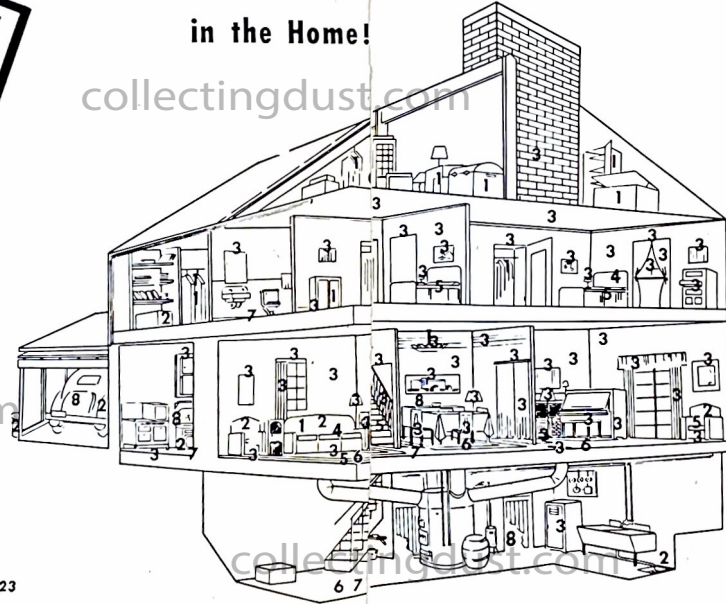

5. RUG CLEANER

Carpets and rugs. Special: Sani Em-tor, the Kirby way of emptying the dirt!



6. ELECTRIC FLOOR DUSTER

Linoleum, cement or tile, or hardwood floors.



7. POWER POLISHER

Linoleum, cement, tile, or hardwood floors, linoleum covered walls sink or table tops.



8. HANDI-BUTLER

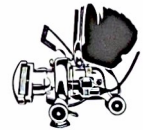

Sheeting buffing wheel for polishing sporting equipment and household metals. Flannel buffing wheel for polishing precious metal jewelry, silver and chromium table and hollow-ware. Grinding wheel for sharpening knives or other edged tools. Wire brush wheel for cleaning dirt, rust and scale from pans, tools and sporting equipment. Lambswool polishing pad for polishing waxed surfaces on wood, metal or leather . . . automobiles, shoes, suitcases and furniture.

Designed to pulverize moth crystals into a fine powder or to make a dense cloud of anti-moth gas, producing and shooting it into the places where it will do the most good in your battle against destructive moth life. There are two arrangements of this unit:

1. Set up the Crystalator unit, load the container with moth crystals, place unit in clothes closet with the Start-Stop switch turned to the ON position, close the door, seal crack at bottom of door with throw rug, plug in the cord and let the motor run for some length of time, until everything is saturated with the gas.
2. Attach the flexible hose to the Crystalator unit as set up in Number 1 and use the extension tubes and the crevice tool to direct the gas and pulverized crystals into the cracks around the baseboards of rooms and into the crevices of upholstered furniture.

Notice the adjustments for "Gas, Medium Crystals, and Full Crystals" on the cap of the Crystalator.

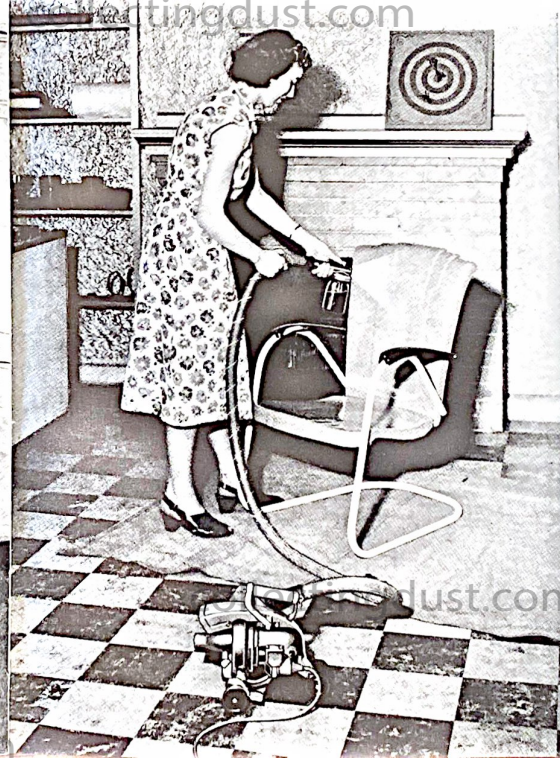

Paints, insecticides and floor wax can be sprayed with the Spray Gun. Insecticides and liquid waxes of a thin consistency can be used as they come from the container. However, brushing paint is usually thick and needs to be thinned when used in a spray gun. Use according to the directions. *Gun and metal tube should be thoroughly cleaned and wiped dry after using. Clean the tube with a pipe cleaner.*

This is a unit which needs a large degree of portability... the machine must be taken to the job. Therefore, the long handle should be removed and the Lifter Grip attached. Remove the Sani Em-tor and bag and attach the Blower Coupler and the Flexible Hose. Fit the Spray Gun into the Coupler Tube at the end of the Flexible Hose.

To fill the Spray Gun Jar:

Unscrew the jar from the cover. Pour into the jar an amount of liquid sufficient to do the job, but an amount not more than three-fourths of the jar's capacity to avoid spillage. Screw the jar firmly back into place.

Test the spray by pressing down the plunger button on top of the Spray Gun with the motor running. Adjust the spray to suit the job by screwing the button up or down. This is a very sensitive adjustment, producing a spray from 'very fine' to almost a 'solid stream'.

Caution: When spraying paint, or some other inflammable liquid, do not attempt to spray near an open flame

The Suds-O-Gun is a companion piece for the Spray Gun. It is an attachment which fits over the nose end of the Spray Gun and is used to produce extra-dry suds for the shampooing of rugs, tapestries and overstuffed furniture.

Many types of detergents and soap solutions may be used. About two tablespoonfuls of any of the popular detergents in a half-pint of water makes excellent suds. If soap flakes or granules are used they must be thoroughly dissolved, otherwise they may clog the small tube or the screen. In operation, the spray jet of suds solution strikes the inner face of the Suds-O-Gun screen and is broken up into bubbles by the air blast. You will note that the valve button on top of the Spray Gun is adjustable. Turning it governs the amount of valve opening . . . a fine spray makes dry suds.

Connect the Spray Gun to the Power Unit in the regular way. Then attach the Suds-O-Gun part



firmly on the nose end of the Sprayer, over the two lugs provided, by turning it clockwise.

The suds can be piled directly on the surface to be cleaned or gathered in a wash basin. Because it contains a minimum of water it does not soak the article to be cleaned. Water can be very harmful if it soaks into the fabric because it can cause mildew and streaking. Heap foam on the surface to be cleaned and scrub a small area until the foam disappears. An ordinary scrub brush is satisfactory, but a natural or synthetic sponge may be used if you prefer. The foam quickly dissolves the film of surface grease and restores the original coloring. In a few moments the surface is dry. If desired, the drying action can be hastened by using a blast of

air from the Kirby flexible hose. A single treatment is usually sufficient, but several may be required in the case of a very dirty rug. It may be necessary to use a second treatment on the arms and head-rest of a chair where most of the dirt collects.

When the surface is dry, remove the loose dry froth and dirt with the Rug Cleaner Nozzle in the case of rugs; and the Upholstery Nozzle in the case of upholstery. This will arrange the pile evenly and smooth out the nap. The very finest of rugs and upholstery materials cannot be harmed by shampooing in this way, because excessive moisture, to soak the material is not required. A long drying period is not necessary and a clean article may be put into use immediately.

KIRBY . . .

**THE NEAREST THING TO
PUSH BUTTON HOUSE CLEANING**

The Portable Unit is used to clean draperies, venetian blinds, lamp shades, moldings, pianos, radiators, walls, stone fireplaces, window shades, lighting fixtures . . . everything above the floor. It is designed to be pulled on wheels over the floor, lifted up stairs or into an automobile with the Lifter Grip handle, and carried using the shoulder strap.

The feather-light Curved and Straight Extension Tubes lengthen the user's reach . . . aid in getting dirt from the very high places (such as moldings, tops of doorways and draperies), and the usually inaccessible low places (such as under stoves, cupboards or radiators).

The Tool Cabinet can be carried to the job along with the Portable Unit. Hang the cabinet on a door knob or the back of a chair to keep the tools in readiness.

The Utility Brush Nozzle brushes up the nap on upholstered furniture and the strong suction carries away the lint and dirt. The Duster Brush with its



long flexible bristles and soft rubber center is designed to loosen the dust from corners and delicate surfaces, such as polished or scroll woodwork, furniture or lamp shades.

To make up the portable unit, unhook cord and bag ring from long handle, then remove the handle after pulling out the handle pin. Replace the floor cleaning handle with the Lifter Grip. Set the Lifter Grip in place by resting it in the groove located near the hole for the handle pin. Insert the handle pin. To remove floor cleaning nozzle, lift the floodlight cover, turn the belt lifter lever, raise the machine to the highest adjustment point of the Toe-Touch Control, turn the nozzle lock and lift off. Put into place the suction coupler, lock and lower flood light cover into working position. Attach the hose to the suction coupler that is in place on the motor unit. Attach the bag ring to rear eye on the lifter grip.

This is the most portable of units and a good part of the success in its use is in having the right tool for a particular type of job.

This is the full-sized power unit with the revolving brush which is used in the cleaning of mattresses, heavy thick cushions, upholstered furniture, and carpeted stairways.

Attach the Sani Em-tor and bag to the exhaust opening of the Power unit and attach bag ring to the rear of the Lifter Grip, which is substituted for the long handle. The Floor Nozzle is in place, and the Toe-Touch Control has lowered the nozzle to the "0" position.

This unit may be operated with or without rotation of the revolving brush. Swing the belt lifter lever to the "Off" position if you do not desire to use the revolving brush.



This is the unit used to clean rugs and carpet kinds. There are various new twist and scuffs on rugs which pose difficulties for many machines, not the Kirby, because of the Toe-Touch Control with which the best cleaning height of the nozzle can readily be secured. The Triple-cushioned vibration-cleaning action can quickly and positively shake loose the deep-down dirt and whisk it into the filter bag. Of course this must be emptied of the dirt collected at reasonable intervals so that the important powerful flow of air is maintained all times. This is the important function of the Sani Em-tor. It makes easy this task of emptying the bag which is so necessary for effective cleaning. The Kirby bag is unusually large, therefore it does not require emptying as often as smaller bags.

TRIPLE-CUSHIONED-VIBRATION CLEANING ACTION

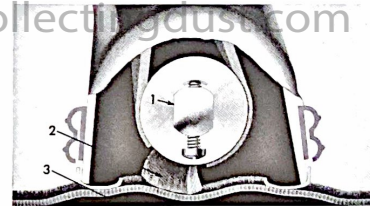

- 1 — Plastic cap cushions.
- 2 — Cushioning resilient bristles.
- 3 — Air Cushions under rug.

collectingdust.com

This set-up is used for the dusting of hardwood, linoleum, cement or other hard-surfaced floors. Tilt the nozzle of the machine up and snap the felt pad into place with the metal clips provided for this purpose. The rubbing of this felt pad loosens the dirt and surface film for the air stream to carry away. The suction will also clean the dirt from the cracks and crevices in the floor.

collectingdust.com

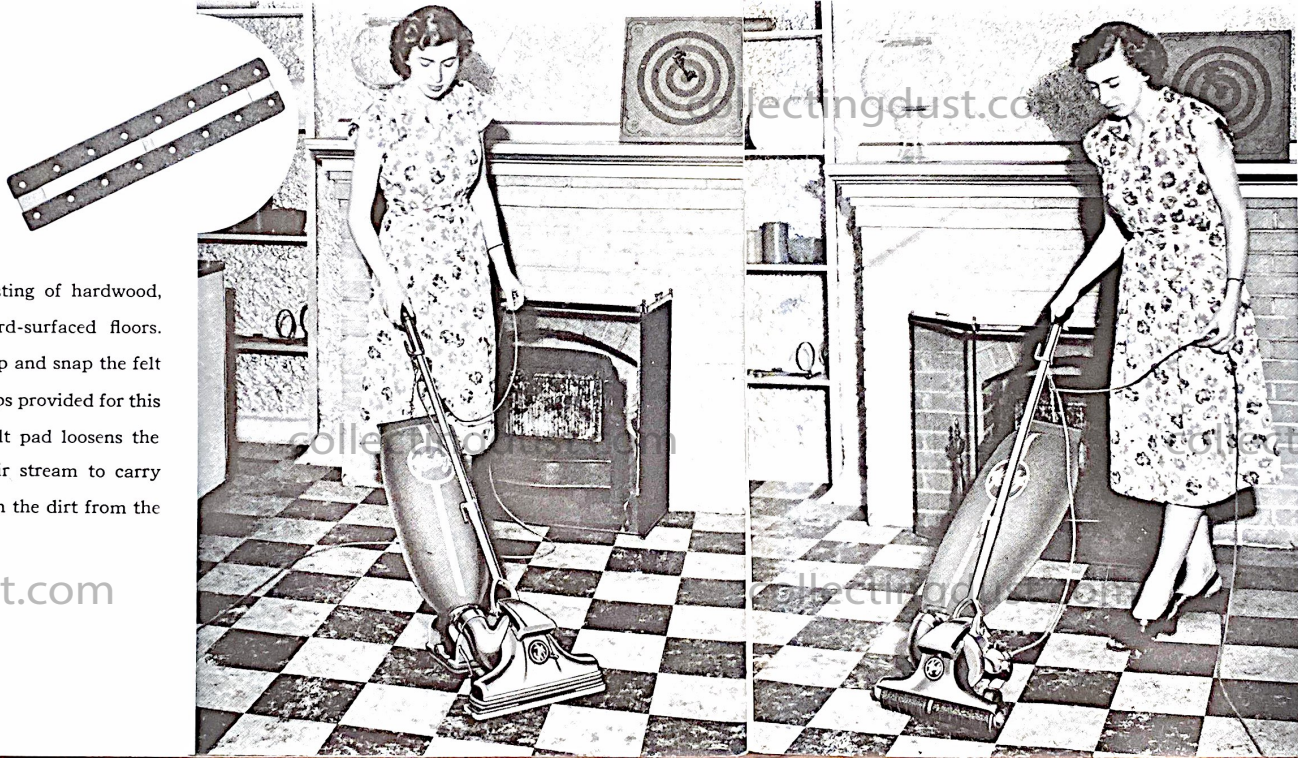

This is the unit that is used to polish the hard-surfaced floors after they have been waxed. Remove the Rug Cleaner Nozzle from the Power Unit. Adjust the Belt Lifter on the Polisher Unit so the belt is stretched and ready to be placed on the machine. Lock the Polisher Nozzle into place and turn the Belt Lifter lever, dropping the belt onto the shaft and ready for operation. Lower the brush to the floor with the Toe-Touch Control, and the machine is ready to operate. The Power Polisher brush, driven by the Power Unit, quickly puts a high polish on any waxed surface.

With the removal of the long handle and the attachment of the Lifter Grip, the Power Polisher Unit can be easily used for the polishing of table and sink tops, linoleum covered walls, or other similar surfaces.

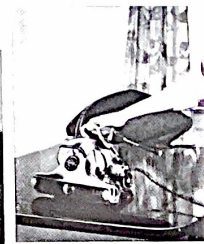
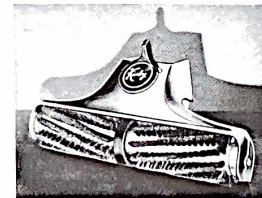

A
LETTER
TO YOU...

Dear Kirby Owner:

I wish to personally welcome you into the ever growing family of owners of the Kirby Sanitation System. I know you will enjoy the use of our product.

Many years of experience and the skill developed by making millions of cleaners have gone into your Kirby. We have spared no efforts to give you a dependable and long-lived machine.

We are building into the Kirby Sanitation System everything which the American lady of the house has come to consider essential . . . work saving, time saving and health saving!

It is a fact that today many more household uses are found for the Kirby than any other machine . . . it is a quality product built to serve you completely. If you will use your Kirby in the ways suggested to you by "The Kirby Man" and follow this instruction book, I am sure you will receive a heaping measure of benefits from your investment.

Cordially,

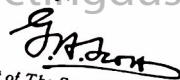

President of The Scott & Fetzer Company

collectingdust.com
HOME OF THE KIRBY

